

STÖRNCH Fixings

Contents

Slotted Steel Channel	22 - 23
Channel End Caps	24
Channel Bracket Sets & Cantilever Arms	25
Channel Nuts & Washers	26
Channel Brackets	27 - 28
Nuts, Bolts & Washers	29
Hot Dip Galv Medium Duty Cable Tray	30 - 31
Light & Medium Duty Cable Tray	32 - 33
Medium Duty Cable Tray Fittings	34 - 35
Heavy Duty Cable Tray	36
Heavy Duty Cable Tray Fittings	37 - 38
Cable Tray Hangers	39
Studbite Tray Hangers	40
Studbite Trapeze Support System	41
Cable Tray Fixings	42
Basket Tray & Fixings	43 - 44
Studding & Fittings	45
Stud Hangers	46 - 47
Wedge Anchors	48
Wedge Nuts & Beam Clamps	49
Lindapters & Flange Clamps	50
Wire Hanging	51 - 52
Anchors & Fixings	53
Wall Fixings, Screws & Driver Bits	54 - 55



Heavy Duty Slotted Channel



41 x 41 mm

- Pre-galvanised
- 2.5mm wall thickness
- 11mm slots
- Used with channel accessories to build frames for the support/suspension of electrical and mechanical services

Part No	Description	Size
GMCN3	Heavy Duty Slotted Channel	41x41mm x 3mt
GMCN3SP	Heavy Duty Slotted Channel	41x41mm x 6mt

Light Duty Slotted Channel



41 x 41 mm

- Pre-galvanised
- 1.5mm wall thickness
- 11mm slots
- Used with channel accessories to build frames for the support/suspension of electrical and mechanical services

Part No	Description	Size
GMCN1	Light Duty Slotted Channel	41x41mm x 3mt

Heavy Duty Slotted Channel



41 x 21 mm

- Pre-galvanised
- 2.5mm wall thickness
- 11mm slots
- Used with channel accessories to build frames for the support/suspension of electrical and mechanical services

Part No	Description	Size
GMCN4	Heavy Duty Slotted Channel	41x21mm x 3mt

Light Duty Slotted Channel



41 x 21 mm

- Pre-galvanised
- 1.5mm wall thickness
- 11mm slots
- Used with channel accessories to build frames for the support/suspension of electrical and mechanical services

Part No	Description	Size
GMCN2	Light Duty Slotted Channel	41x21mm x 3mt



Heavy Duty Slotted Back-to-Back Channel



41 x 82 mm

- Pre-galvanised
- 2.5mm wall thickness
- 11mm slots
- Used with channel accessories to build frames for the support/suspension of electrical and mechanical services

Part No	Description	Size
GMCN3B	Back-to-Back Channel	41x82mm x 3mt
GMCN3B6	Back-to-Back Channel	41x82mm x 6mt

Deep Channel Sockets

STÖRNCH



- Fits easily inside strut channel to fix fastenings
- GMHS39 fixes M8 fastenings
- GMHS40 fixes M10 fastenings

Part No	Description	Size
GMHS39	Deep Channel Socket 1/2" Drive	13mm
GMHS40	Deep Channel Socket 1/2" Drive	17mm

STÖRNCH Channel End Caps 41x41mm

STÖRNCH



- Provides a pleasant aesthetic finish
- Prevents exposed sharp edges, meeting health & safety requirements

Part No	Description	Size	Qty/Pk
GMCN16B	Black End Cap	41mm x 41mm	pk 100

Part No	Description	Size	Qty/Pk
GMCN16G	Lt Grey End Cap	41mm x 41mm	pk 100
GMCN16W	White End Cap	41mm x 41mm	pk 100

STÖRNCH Channel End Caps 41x21mm

STÖRNCH



- Provides a pleasant aesthetic finish
- Prevents exposed sharp edges, meeting health & safety requirements

Part No	Description	Size	Qty/Pk
GMCN17B	Black End Cap	41mm x 21mm	pk 100

Part No	Description	Size	Qty/Pk
GMCN17G	Lt Grey End Cap	41mm x 21mm	pk 100
GMCN17W	White End Cap	41mm x 21mm	pk 100

STÖRNCH Light Duty Channel End Caps 41x21mm

STÖRNCH

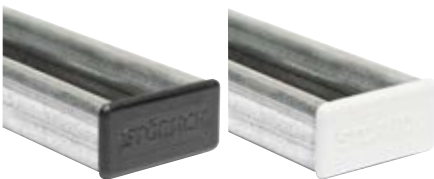

- Provides a pleasant aesthetic finish
- Prevents exposed sharp edges, meeting health & safety requirements

Part No	Description	Size
GMCNL17B	Light Duty Channel End Cap Black	41 x 21mm
GMCNL17W	Light Duty Channel End Cap White	41 x 21mm



STÖRNCH Ready-To-Go Bracket Sets

STÖRNCH
Condenser Support



- The STÖRNCH "Ready-to-go" set is a cantilever set flat packed with all the necessary fixings for an installation.
- Save time on site - time is money!

SET CONTAINS:

- 1 pair of Cantilever Arms
- End Caps
- Channel Nuts
- 2 Lengths of 41 x 41mm x 750mm H.D. Channel
- Rawlbolts
- Bolts and Washers



Part No	Description	Size	Weight
GMCN20	Ready-To-Go Bracket Set	450mm	160kg
GMCN21	Ready-To-Go Bracket Set	600mm	160kg
GMCN5	Ready-To-Go Bracket Set	750mm	160kg

Cantilever Bracket Arms



Part No	Description	Size
GMCN32	Cantilever Arm	300mm
GMCN18	Cantilever Arm	450mm
GMCN19	Cantilever Arm	600mm
GMCN31	Cantilever Arm	750mm
GMCN33	Cantilever Arm	900mm
GMCN36	Cantilever Arm	1000mm

- Hot-dip galvanised
- Used for pipework support and mounting air conditioning units to walls
- Can be used with channel using channel nuts

Part No	Description	Size
GMCN18D	Back-to-Back Cantilever Arm	450mm
GMCN19D	Back-to-Back Cantilever Arm	600mm

Channel Nuts - Plain

STÖRNCH



- Zinc plated (BZP)
- Used in channel support systems

Part No	Description	Size	Qty/Pk
GMCN22	Channel Nuts - Plain	M6	pk 100
GMCN23	Channel Nuts - Plain	M8	pk 100
GMCN24	Channel Nuts - Plain	M10	pk 100
GMCN43	Channel Nuts - Plain	M12	pk 100

Slide Nuts

UNISTRUT®



- Square plate and channel nut in one
- Plastic component made of polyamide (PA6)

Part No	Description	Size	Qty/Pk
GMFX96-50	Slide Nuts	M8	pk 50
GMFX97-50	Slide Nuts	M10	pk 50

Channel Nuts - Short Spring

STÖRNCH



- Zinc plated (BZP)
- Perfect for shallow channel and fixing systems
- Quick and easy to insert and fix into channel

Part No	Description	Size	Qty/Pk
GMCN25	Channel Nuts - Short Spring	M6	pk 100
GMCN26	Channel Nuts - Short Spring	M8	pk 100
GMCN27	Channel Nuts - Short Spring	M10	pk 100

Square Plate Washers

STÖRNCH



- Zinc plated (BZP)

Part No	Description	Size	Qty/Pk
GMFX92	M8 Square Plate Washers	40 x 40 x 3mm	pk 100
GMFX93	M10 Square Plate Washers	40 x 40 x 3mm	pk 100

Channel Nuts - Long Spring

STÖRNCH



- Zinc plated (BZP)
- Perfect for deeper channel and fixing systems
- Quick and easy to insert and fix into channel

Part No	Description	Size	Qty/Pk
GMCN28	Channel Nuts - Long Spring	M6	pk 100
GMCN29	Channel Nuts - Long Spring	M8	pk 100
GMCN30	Channel Nuts - Long Spring	M10	pk 100

Heavy Duty Channel Plate Washers

STÖRNCH



- Zinc plated (BZP)

Part No	Description	Size	Qty/Pk
GMFX94	M8 Channel Plate Washers	40 x 40 x 5mm	pk 100
GMFX95	M10 Channel Plate Washers	40 x 40 x 5mm	pk 100

Angle Bracket - 2 Hole



- Hot-dip galvanised
- Used to join sections of channel together when installing channel support systems

Part No	Description
GMCN10	90° Angle Bracket - 2 Hole

Angle Bracket - 3 Hole



- Hot-dip galvanised
- Used to join sections of channel together when installing channel support systems

Part No	Description
GMCN10B	90° Angle Bracket - 3 Hole

Angle Bracket - 4 Hole



- Hot-dip galvanised
- Used to join sections of channel together when installing channel support systems

Part No	Description
GMCN11	90° Angle Bracket - 4 Hole

Obtuse Angle Bracket



- Hot-dip galvanised
- Used to join sections of channel together when installing channel support systems

Part No	Description
GMCN14	Obtuse Angle Bracket

Corner Plate Bracket - 3 Hole



- Hot-dip galvanised
- Used to join sections of channel together when installing channel support systems

Part No	Description
GMCN13B	Flat Corner Plate Bracket - 3 Hole

Tee Bracket - 4 Hole



- Hot-dip galvanised
- Used to join sections of channel together when installing channel support systems

Part No	Description
GMCN13	Tee Bracket - 4 Hole

Window Brackets



- Hot-dip galvanised
- For clamping channel to beams
- Designed to assist with a wide range of applications, involving mounting and supporting channel systems

Part No	Description	Size
GMCN7	Window Bracket c/w M10 Cone Point Bolt	41mm x 21mm
GMCN6	Window Bracket c/w M10 Cone Point Bolt	41mm x 41mm
GMCN60A	Window Bracket c/w M10 Cone Point Bolt	41mm x 82mm

Flat Plate Bracket - 4 Hole



- Hot-dip galvanised
- Used when installing channel support systems, to join sections of channel together

Part No	Description
GMCN12	Flat Plate Bracket - 4 Hole

Double Fix Base Plate



- Hot-dip galvanised
- Designed for use with channel
- The two holes in the baseplate are for fastening to the floor using anchors and bolts
- The two upright brace holes are for fastening to channel

Part No	Description	Size
GMCN15	Double Fix Base Plate	41mm x 41mm

Internal Channel Joiners



- Hot-dip galvanised
- Used when installing channel support systems, to join sections of channel together

Part No	Description	Size
GMCN8	Internal Channel Joiner	41mm x 41mm
GMCN9	Internal Channel Joiner	41mm x 21mm

Double Fix Base Plate



- Hot-dip galvanised
- Designed for use with channel
- The two holes in the baseplate are for fastening to the floor using anchors and bolts
- The four upright brace holes are for fastening to channel

Part No	Description	Size
GMCN60B	Double Fix Base Plate	41mm x 82mm

H.T. (High Tensile) Bolts



- High tensile 8.8
- Zinc plated (BZP)
- Fully threaded
- Conforms to DIN 933

Part No	Description	Size	Qty/Pk
GMFX50	H.T. Bolts	M8 x 20mm	pk 100
GMFX51	H.T. Bolts	M8 x 25mm	pk 100
GMFX52	H.T. Bolts	M8 x 30mm	pk 100
GMFX53	H.T. Bolts	M8 x 40mm	pk 100
GMFX58	H.T. Bolts	M10 x 20mm	pk 100
GMFX54	H.T. Bolts	M10 x 25mm	pk 100
GMFX55	H.T. Bolts	M10 x 30mm	pk 100
GMFX56	H.T. Bolts	M10 x 40mm	pk 100
GMFX57	H.T. Bolts	M10 x 60mm	pk 100

Penny Washers



- Zinc plated (BZP)
- Also known as repair washers or mudguard washers

Part No	Description	Size	Qty/Pk
GMFX83	Penny Washers	M6 x 25mm	pk 100
GMFX85	Penny Washers	M8 x 25mm	pk 100
GMFX86	Penny Washers	M8 x 30mm	pk 100
GMFX87	Penny Washers	M8 x 38mm	pk 100
GMFX89	Penny Washers	M10 x 25mm	pk 100
GMFX90	Penny Washers	M10 x 30mm	pk 100

Hex Nuts



- Zinc plated (BZP)
- For use with bolts and threaded rod
- Conforms to DIN 934

Part No	Description	Size	Qty/Pk
GMFX72	Hex Nuts	M6	pk 100
GMFX73	Hex Nuts	M8	pk 100
GMFX74	Hex Nuts	M10	pk 100
GMFX77	Hex Nuts	M12	pk 100

Serrated Flange Nuts



- Zinc plated (BZP)
- Larger clamping & locking force than a standard hex nut

Part No	Description	Size	Qty/Pk
GMFX79	Flange Nuts	M8	pk100
GMFX80	Flange Nuts	M10	pk100

M8 Form G Washers



- Zinc plated (BZP)
- Inside diameter 8.4mm
- Outside diameter 24mm
- Thickness 2mm

Part No	Description	Size	Qty/Pk
GMFX81	G Washer	M8	pk100

Hot Dip Galv Med Duty Cable Tray



Hot Dip Galv

- Hot dip galvanised
- Medium duty return flange

Part No	Description	Size
GMGT1	Hot Dip Galv Med Duty Cable Tray	75mm (3") x 3mt

Hot Dip Galv Med Duty Cable Tray



Hot Dip Galv

- Hot dip galvanised
- Medium duty return flange

Part No	Description	Size
GMGT2	Hot Dip Galv Med Duty Cable Tray	100mm (4") x 3mt

Hot Dip Galv Med Duty Cable Tray



Hot Dip Galv

- Hot dip galvanised
- Medium duty return flange

Part No	Description	Size
GMGT3	Hot Dip Galv Med Duty Cable Tray	150mm (6") x 3mt

Hot Dip Galv Med Duty Cable Tray



Hot Dip Galv

- Hot dip galvanised
- Medium duty return flange

Part No	Description	Size
GMGT4	Hot Dip Galv Med Duty Cable Tray	225mm (9") x 3mt

Hot Dip Galv Med Duty Cable Tray



Hot Dip Galv

- Hot dip galvanised
- Medium duty return flange

Part No	Description	Size
GMGT5	Hot Dip Galv Med Duty Cable Tray	300mm (12") x 3mt

Hot Dip Galv Med Duty Cable Tray



Hot Dip Galv

- Hot dip galvanised
- Medium duty return flange

Part No	Description	Size
GMGT6	Hot Dip Galv Med Duty Cable Tray	450mm (18") x 3mt

Hot Dip Galv Med Duty Cable Tray



Hot Dip Galv

- Hot dip galvanised
- Medium duty return flange

Part No	Description	Size
GMGT7	Hot Dip Galv Med Duty Cable Tray	600mm (24") x 3mt

Hot Dip Galv MD Wrapover Couplers

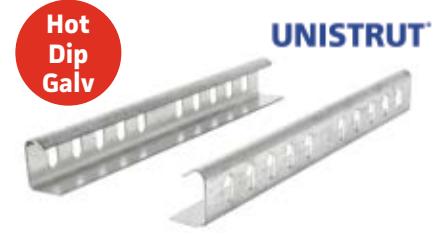

Hot Dip Galv

- For joining 2 lengths of medium duty cable tray on a straight run
- Hot dip galvanised
- Sold as a pair

Part No	Description	Qty/Pk
GMGT8W	Hot Dip Galv Med Duty Cable Tray Couplers	Pair



Pre-Galv Light Duty Cable Tray



- Pre-galvanised
- No return flange
- Flared ends for self-joining (no couplers required)

Part No	Description	Size
GMTR0	Light Duty Cable Tray	50mm (2") x 3mt

Pre-Galv Medium Duty Cable Tray



- Pre-galvanised
- Medium duty return flange

Part No	Description	Size
GMTR1	Medium Duty Cable Tray	75mm (3") x 3mt

Pre-Galv Medium Duty Cable Tray



- Pre-galvanised
- Medium duty return flange

Part No	Description	Size
GMTR2	Medium Duty Cable Tray	100mm (4") x 3mt

Pre-Galv Medium Duty Cable Tray



- Pre-galvanised
- Medium duty return flange

Part No	Description	Size
GMTR3	Medium Duty Cable Tray	150mm (6") x 3mt

Pre-Galv Medium Duty Cable Tray



- Pre-galvanised
- Medium duty return flange

Part No	Description	Size
GMTR4	Medium Duty Cable Tray	225mm (9") x 3mt

Pre-Galv Medium Duty Cable Tray



- Pre-galvanised
- Medium duty return flange

Part No	Description	Size
GMTR5	Medium Duty Cable Tray	300mm (12") x 3mt

Pre-Galv Medium Duty Cable Tray



- Pre-galvanised
- Medium duty return flange

Part No	Description	Size
GMTR6	Medium Duty Cable Tray	450mm (18") x 3mt

Pre-Galv Medium Duty Cable Tray



- Pre-galvanised
- Medium duty return flange

Part No	Description	Size
GMTR7	Medium Duty Cable Tray	600mm (24") x 3mt

Straight Cable Tray Couplers



- For joining 2 lengths of medium duty cable tray on a straight run
- Pre-galvanised
- Sold as a pair

Part No	Description	Qty/Pk
GMTR8S	Straight Cable Tray Couplers	Pair

Medium Duty Wrapover Couplers



- For joining 2 lengths of medium duty cable tray on a straight run
- Pre-galvanised
- Sold as a pair

Part No	Description	Qty/Pk
GMTR8W	Medium Duty Cable Tray Couplers	Pair

TrayBite® Cable Tray Couplers & ThreadBite® Screws



- Self tapping ThreadBite screws replace the need for traditional nut and bolt fixing

- Time saving product - no longer requiring fiddly square nuts and spanners
- Wrapover coupler
- Only suitable for medium duty cable tray



Part No	Description	Qty/Pk
GMTR61	TrayBite Wrapover Couplers	10 Pairs
GMTR62	ThreadBite Screws	pk 250

Pre-Galv Medium Duty Cable Tray 90° Flat Bends



- Pre-galvanised
- Medium duty return flange

Part No	Description	Size
GMTR20	90° Flat Bend	100mm (4")
GMTR21	90° Flat Bend	150mm (6")
GMTR22	90° Flat Bend	225mm (9")

Part No	Description	Size
GMTR23	90° Flat Bend	300mm (12")
GMTR24	90° Flat Bend	450mm (18")
GMTR25	90° Flat Bend	600mm (24")

Pre-Galv Medium Duty Cable Tray 45° Flat Bends



- Pre-galvanised
- Medium duty return flange

Part No	Description	Size
GMMD45100	45° Flat Bend	100mm (4")
GMMD45150	45° Flat Bend	150mm (6")
GMMD45225	45° Flat Bend	225mm (9")

Part No	Description	Size
GMMD45300	45° Flat Bend	300mm (12")
GMMD45450	45° Flat Bend	450mm (18")
GMMD45600	45° Flat Bend	600mm (24")

Pre-Galv Medium Duty Cable Tray Equal Reducers



- Pre-galvanised
- Medium duty return flange

Part No	Description	Size
GMTR37	Equal Reducer	150mm - 100mm
GMTR38	Equal Reducer	225mm - 150mm
GMTR39	Equal Reducer	300mm - 225mm

Part No	Description	Size
GMTR40	Equal Reducer	450mm - 300mm
GMTR41	Equal Reducer	600mm - 450mm

Pre-Galv Medium Duty Cable Tray Equal Tees



- Pre-galvanised
- Medium duty return flange

Part No	Description	Size
GMTR28	Equal Tee	100mm (4")
GMTR29	Equal Tee	150mm (6")
GMTR30	Equal Tee	225mm (9")

Part No	Description	Size
GMTR31	Equal Tee	300mm (12")
GMTR32	Equal Tee	450mm (18")
GMTR33	Equal Tee	600mm (24")

Medium Duty Cable Tray Channel Clips



- Simply slip the clip into the channel and snap it over the return flange of the tray
- Removes the need for fiddly spring nuts and bolts, saving the installer time

Part No	Description	Qty/Pk
GMTR50	Cable Tray Channel Clips	pk 50



Pre-Galv Heavy Duty Cable Tray

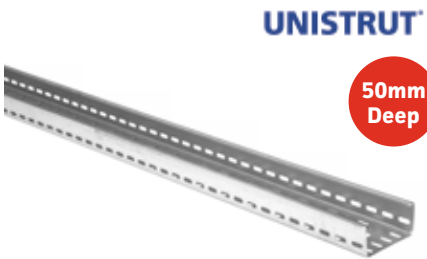

- Pre-galvanised
- Heavy duty return flange

Part No	Description	Size
GMHD100	Heavy Duty Cable Tray	100mm (4") x 3mt

Pre-Galv Heavy Duty Cable Tray

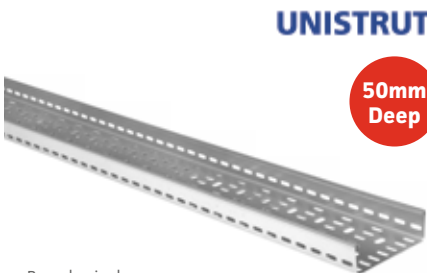

- Pre-galvanised
- Heavy duty return flange

Part No	Description	Size
GMHD150	Heavy Duty Cable Tray	150mm (6") x 3mt

Pre-Galv Heavy Duty Cable Tray

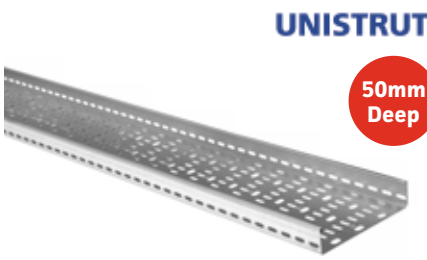

- Pre-galvanised
- Heavy duty return flange

Part No	Description	Size
GMHD225	Heavy Duty Cable Tray	225mm (9") x 3mt

Pre-Galv Heavy Duty Cable Tray

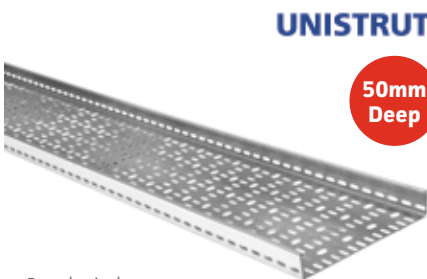

- Pre-galvanised
- Heavy duty return flange

Part No	Description	Size
GMHD300	Heavy Duty Cable Tray	300mm (12") x 3mt

Pre-Galv Heavy Duty Cable Tray

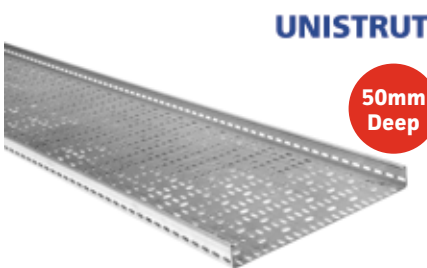

- Pre-galvanised
- Heavy duty return flange

Part No	Description	Size
GMHD450	Heavy Duty Cable Tray	450mm (18") x 3mt

Pre-Galv Heavy Duty Cable Tray

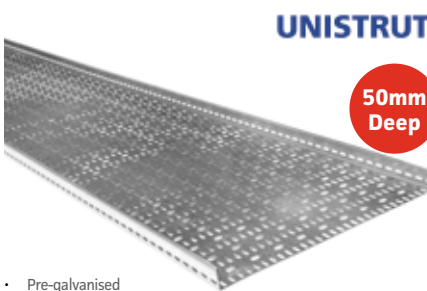

- Pre-galvanised
- Heavy duty return flange

Part No	Description	Size
GMHD600	Heavy Duty Cable Tray	600mm (24") x 3mt

Heavy Duty Wrapover Couplers



- For joining two lengths of heavy duty cable tray on a straight run
- Pre-galvanised
- Sold as a pair

Part No	Description	Qty/Pk
GMHDC	Heavy Duty Cable Tray Couplers	Pair

Heavy Duty Cable Tray Channel Clip

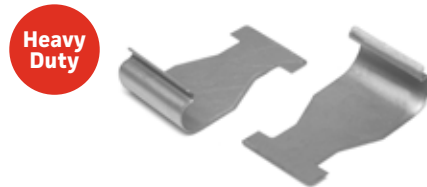

- This clip is used for quickly connecting heavy duty return flange cable tray to channel. Simply twist the clip into the channel and clip it over the side of the tray. Repeat on the other side, and job done!
- Zinc plated finish

Part No	Description	Qty/Pk
GMTR51-50	Heavy Duty Cable Tray Channel Clip	pk50

Pre-Galv Heavy Duty Cable Tray 90° Flat Bends



- Pre-galvanised
- Heavy duty return flange

Part No	Description	Size
GMHDB90100	90° Flat Bend	100mm (4")
GMHDB90150	90° Flat Bend	150mm (6")
GMHDB90225	90° Flat Bend	225mm (9")

Part No	Description	Size
GMHDB90300	90° Flat Bend	300mm (12")
GMHDB90450	90° Flat Bend	450mm (18")
GMHDB90600	90° Flat Bend	600mm (24")

Pre-Galv Heavy Duty Cable Tray 45° Flat Bends



- Pre-galvanised
- Heavy duty return flange

Part No	Description	Size
GMHD45100	45° Flat Bend	100mm (4")
GMHD45150	45° Flat Bend	150mm (6")
GMHD45225	45° Flat Bend	225mm (9")

Part No	Description	Size
GMHD45300	45° Flat Bend	300mm (12")
GMHD45450	45° Flat Bend	450mm (18")
GMHD45600	45° Flat Bend	600mm (24")

Pre-Galv Heavy Duty Cable Tray Equal Reducers

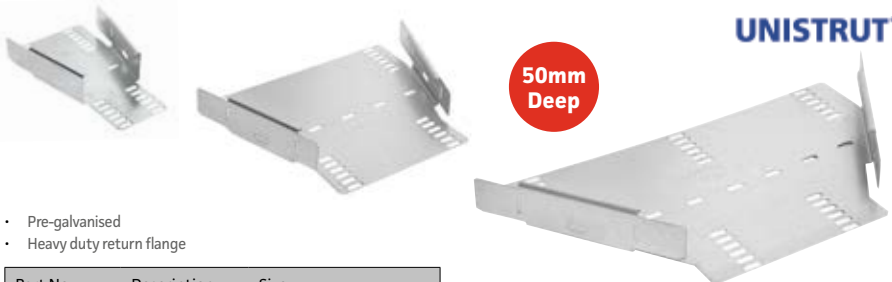

- Pre-galvanised
- Heavy duty return flange

Part No	Description	Size
GMHDR1510	Equal Reducer	150mm - 100mm
GMHDR2215	Equal Reducer	225mm - 150mm
GMHDR3022	Equal Reducer	300mm - 225mm

Part No	Description	Size
GMHDR4530	Equal Reducer	450mm - 300mm
GMHDR6045	Equal Reducer	600mm - 450mm

Pre-Galv Heavy Duty Cable Tray Equal Tees



- Pre-galvanised
- Heavy duty return flange

Part No	Description	Size
GMHDT100	Equal Tee	100mm (4")
GMHDT150	Equal Tee	150mm (6")
GMHDT225	Equal Tee	225mm (9")

Part No	Description	Size
GMHDT300	Equal Tee	300mm (12")
GMHDT450	Equal Tee	450mm (18")
GMHDT600	Equal Tee	600mm (24")

Cable Tray Stand Off Brackets

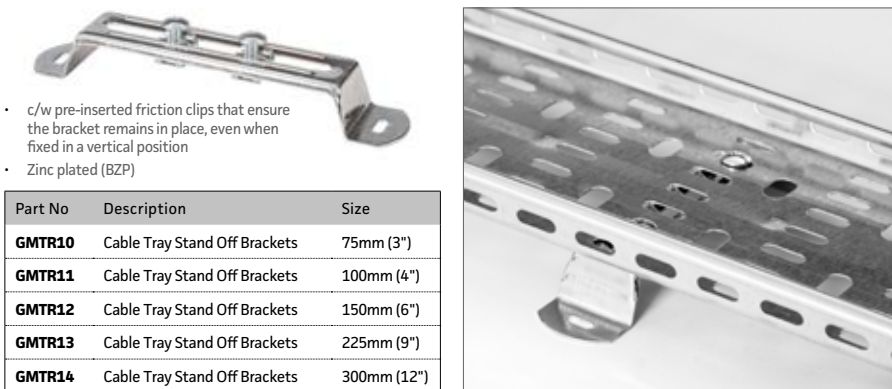

- c/w pre-inserted friction clips that ensure the bracket remains in place, even when fixed in a vertical position
- Zinc plated (BZP)

Part No	Description	Size
GMTR10	Cable Tray Stand Off Brackets	75mm (3")
GMTR11	Cable Tray Stand Off Brackets	100mm (4")
GMTR12	Cable Tray Stand Off Brackets	150mm (6")
GMTR13	Cable Tray Stand Off Brackets	225mm (9")
GMTR14	Cable Tray Stand Off Brackets	300mm (12")

Overhead Cable Tray Hangers



- Lightweight support for cable tray runs parallel to ceilings
- Fits overs strut, can be suspended from studding, or fixed directly to ceilings and walls

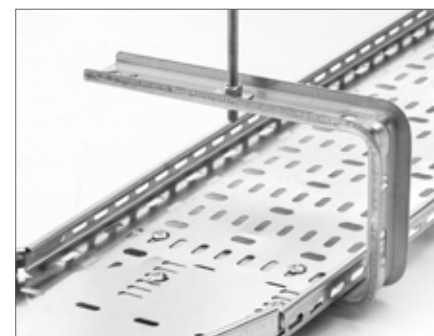

Part No	Description	Size
GMTR15	Overhead Cable Tray Hanger	100mm (4")
GMTR16	Overhead Cable Tray Hanger	150mm (6")
GMTR17	Overhead Cable Tray Hanger	225mm (9")
GMTR18	Overhead Cable Tray Hanger	300mm (12")

Unitrunk Cable Tray Hangers



- Pre-galvanised
- Used to support horizontal runs of cable tray, suspended from threaded rod



Part No	Description	Size
CMOTH100	Unitrunk Cable Tray Hanger	100mm (4")
CMOTH150	Unitrunk Cable Tray Hanger	150mm (6")
CMOTH225	Unitrunk Cable Tray Hanger	225mm (9")
CMOTH300	Unitrunk Cable Tray Hanger	300mm (12")

Platform Overhead Cable Tray Hangers

- Pre-galvanised
- Used to support runs of cable tray
- Hung from a single threaded rod

Part No	Description	Size
GMRHG100	Platform Overhead Tray Hanger	100mm (4")
GMRHG150	Platform Overhead Tray Hanger	150mm (6")
GMRHG225	Platform Overhead Tray Hanger	225mm (9")
GMRHG300	Platform Overhead Tray Hanger	300mm (12")



StudBite Single Stud Hanger



Use With ThreadBite Screws

- Multiple fixing options
- Easily adjustable up and down stud
- Use ThreadBite Screws to fix cable tray directly to the hanger

Part No	Description	Size
GMSB9	StudBite Single Stud Hanger	100mm (4")

StudBite Single Stud Hanger



Use With ThreadBite Screws

- Multiple fixing options
- Easily adjustable up and down stud
- Use ThreadBite Screws to fix cable tray directly to the hanger

Part No	Description	Size
GMSB10	StudBite Single Stud Hanger	150mm (6")

StudBite Single Stud Hanger



Use With ThreadBite Screws

- Multiple fixing options
- Easily adjustable up and down stud
- Use ThreadBite Screws to fix cable tray directly to the hanger

Part No	Description	Size
GMSB11	StudBite Single Stud Hanger	225mm (9")

StudBite Single Stud Hanger



Use With ThreadBite Screws

- Multiple fixing options
- Easily adjustable up and down stud
- Use ThreadBite Screws to fix cable tray directly to the hanger

Part No	Description	Size
GMSB12	StudBite Single Stud Hanger	300mm (12")

StudBite Retro-Fit Clamp



- Unique retrofit clip can fix straight to side of M8/M10 existing stud

Part No	Description	Qty/Pk
GMSB13	Optional Retro-Fit Clamp	Each

StudBite Basket Tray Clamp



- The Basket Tray Clamp is used to fix basket tray to the hanger using the ThreadBite Screws

Part No	Description	Qty/Pk
GMSB14	Basket Tray Clamp	Each

StudBite Trapeze Support Kits

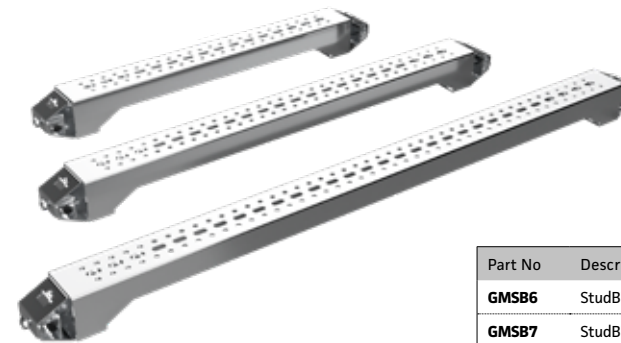

- Building multi-tier trapeze supports has never been easier
- No nuts, washers or channel end caps needed
- No need to deburr stud ends
- Easily adjustable up and down stud
- Use ThreadBite Screws to fix cable tray directly to channel support.
- Trapeze Support Kits include 2 end brackets

Part No	Description	Size
GMSB6	StudBite Trapeze Support Kit	300mm (12")
GMSB7	StudBite Trapeze Support Kit	450mm (18")
GMSB8	StudBite Trapeze Support Kit	600mm (24")

Trapeze Support Adapters



- Building trapeze support brackets onsite or offsite made easy.
- By inverting this product it can be used as support in a traditional channel trapeze
- No nuts, washers or channel end caps needed!
- Easily adjustable up and down stud

Part No	Description	Qty/Pk
GMSB3	Support Adapters	Pair

Inverted Channel Adapter Clamp



- Compatible with M8/M10 stud and deep/shallow channel, StudBite Channel-to-Stud Adapters have been specifically designed to work with (not replace) tried and trusted industry-standard products

Part No	Description	Qty/Pk
GMSB4	Inverted Channel Adapter Clamp	Each

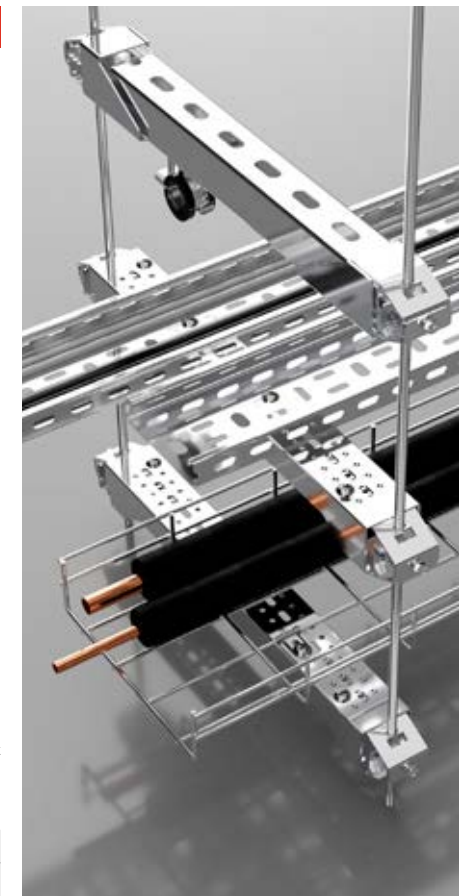

PZ (Pozi) Tray Bolts & Serrated Flange Nuts



Part No	Description	Size	Qty/Pk
GMTB616	Tray Bolts & Nuts	M6 x 16mm	pk 200
GMTB620	Tray Bolts & Nuts	M6 x 20mm	pk 200
GMTB625	Tray Bolts & Nuts	M6 x 25mm	pk 200

- Zinc plated (BZP)
- The flange eliminates using a washer in some installs saving time for the installer
- Serrations on the flange bind tightly to the material

Roofing Bolts & Nuts



- Zinc plated (BZP)
- Fully threaded
- Square nuts included

Part No	Description	Size	Qty/Pk
GMFX60	Roofing Bolts & Nuts	M6 x 16mm	pk 200
GMFX61	Roofing Bolts & Nuts	M6 x 20mm	pk 200
GMFX62	Roofing Bolts & Nuts	M6 x 25mm	pk 200

EB100 Unistrut Earth Strap



- Zinc plated
- M10 hole size

Part No	Description	Qty/Pk
GMTR54	EB100 Unistrut Earth Strap	pk 10



Quik-Click Basket Tray



- Comes c/w pre-fixed couplers, enabling rapid installation and joining of lengths
- Zinc plated (BZP)

Part No	Description	Size
GMBTR100M	Quik-Click Basket Tray	100mm x 55mm x 3mt

Quik-Click Basket Tray



- Comes c/w pre-fixed couplers, enabling rapid installation and joining of lengths
- Zinc plated (BZP)

Part No	Description	Size
GMBTR150M	Quik-Click Basket Tray	150mm x 55mm x 3mt

Quik-Click Basket Tray



- Comes c/w pre-fixed couplers, enabling rapid installation and joining of lengths
- Zinc plated (BZP)

Part No	Description	Size
GMBTR200M	Quik-Click Basket Tray	200mm x 55mm x 3mt

Quik-Click Basket Tray



- Comes c/w pre-fixed couplers, enabling rapid installation and joining of lengths
- Zinc plated (BZP)

Part No	Description	Size
GMBTR300M	Quik-Click Basket Tray	300mm x 55mm x 3mt

Quik-Click Basket Tray



- Comes c/w pre-fixed couplers, enabling rapid installation and joining of lengths
- Zinc plated (BZP)

Part No	Description	Size
GMBTR400M	Quik-Click Basket Tray	400mm x 55mm x 3mt

Quik-Click Basket Tray



- Comes c/w pre-fixed couplers, enabling rapid installation and joining of lengths
- Zinc plated (BZP)

Part No	Description	Size
GMBTR600M	Quik-Click Basket Tray	600mm x 55mm x 3mt

Central Suspension Hanger



- Used to suspend cable tray from threaded rod (up to M10)
- Fast and simple installation

Part No	Description	Qty/Pk
GMBTR18M	Central Suspension Hangers	pk 25

Fast-Fix Universal Strut Clip



- Allows basket tray to be fastened to channel both quickly and easily
- Made secure with one turn of a screwdriver
- Eliminates the need for any special tools
- c/w appropriate screwdriver

Part No	Description	Qty/Pk
GMBTR22M	Fast-Fix Universal Strut Clips	pk 50

Nut Bolt Clamp Assembly

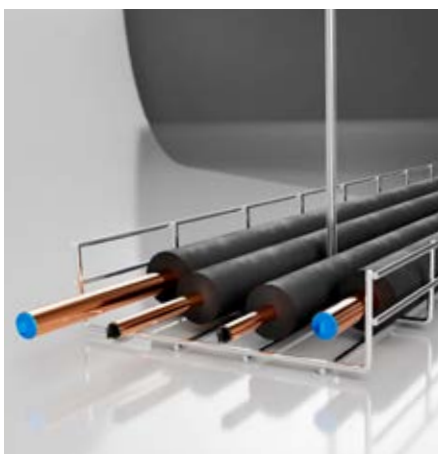

- Used when coupling two pieces of basket tray together
- Easy to install and remove if necessary
- Zinc plated (BZP)

Part No	Description	Qty/Pk
GMBTR23M	Nut Bolt Clamp Assembly	pk 50

BZP Studding/Threaded Rods



- Zinc plated (BZP)
- Common fixing for support systems, and used for a variety of applications

Part No	Description	Qty/Pk
GMCN34	M8 x 3mt Studding/Threaded Rod	Each
GMCN35	M10 x 3mt Studding/Threaded Rod	Each
GMCN40	M12 x 3mt Studding/Threaded Rod	Each

Studding End Caps - Black



- Protects the studding end from impact
- Provides a pleasant aesthetic finish
- Prevents exposed sharp edges

Part No	Description	Colour	Qty/Pk
GMCN41B	M8 Studding End Caps	Black	pk 100
GMCN42B	M10 Studding End Caps	Black	pk 100

Studding End Caps - Grey



- Protects the studding end from impact
- Provides a pleasant aesthetic finish
- Prevents exposed sharp edges

Part No	Description	Colour	Qty/Pk
GMCN41G	M8 Studding End Caps	Light Grey	pk 100
GMCN42G	M10 Studding End Caps	Light Grey	pk 100

Studding End Caps - White



- Protects the studding end from impact
- Provides a pleasant aesthetic finish
- Prevents exposed sharp edges

Part No	Description	Colour	Qty/Pk
GMCN41W	M8 Studding End Caps White	White	pk 100
GMCN42W	M10 Studding End Caps White	White	pk 100

Studding Connectors



- Provides a fast and economic connection for two lengths of studding
- Zinc plated (BZP)
- Can also be used for a number of applications where a taller nut is required

Part No	Description	Qty/Pk
GMCN37-25	M8 Studding Connectors	pk 25
GMCN38-25	M10 Studding Connectors	pk 25

Munson Base



- Used to attached studding to a flat surface
- Dual tapped to accept M8 or M10 threads
- Zinc plated (BZP)

Part No	Description	Qty/Pk
GMJ12A-25	Dual Tapped Munson Bases BZP	pk 25

Concrete Screw Stud Hangers

STÖRNCH



**M8/
M10
Concrete**

- Setting and installation in one working operation saves time
- Completely removable therefore suitable for temporary fixings
- M8/M10 dual tapped connector
- Drill 6mm hole. Must be drilled to the correct depth

Part No	Description	Size	Hole Size	Qty/Pk
GMFX103-100	Stud Hanger	M8 x 35mm	6mm	pk 100
GMFX104-100	Stud Hanger	M8 x 55mm	6mm	pk 100

Hammer-In Stud Hanger



**M8/
M10
Concrete**

- The Dual Thread allows for the use of M8 or M10 threaded rod with the need for only one socket
- Auto expanding action
- Fast and secure Installation
- No torque wrench required
- Hole size 6mm

Part No	Description	Size	Qty/Pk
GMFX105-100	Stud Hanger	M8/M10 x 30mm	pk 100

Wood Fixing Vertical Stud Hanger



**M8
Wood**

- An internally threaded socket for hanging rods vertically in wood
- Inserted using the GMFX127-100 Setting Tool

Part No	Description	Size	Qty/Pk
GMFX117-100	Stud Hanger	M8 x 25mm	pk 100

Wood Fixing Vertical Stud Hanger



**M10
Wood**

- An internally threaded socket for hanging rods vertically in wood
- Inserted using the GMFX127-100 Setting Tool

Part No	Description	Size	Qty/Pk
GMFX123-50	Stud Hanger	M10 x 63mm	pk 50

Metal Fixing Vertical Stud Hangers



**M8
Metal**

- An internally threaded socket for hanging rods vertically in light section steel
- Inserted using the GMFX127-100 Setting Tool

Part No	Description	Size	Qty/Pk
GMFX106-100	Stud Hanger	M8 x 25mm	pk 100
GMFX107-100	Stud Hanger	M8 x 38mm	pk 100

Metal Fixing Vertical Stud Hangers



**M10
Metal**

- An internally threaded socket for hanging rods vertically in light section steel
- Inserted using the GMFX127-100 Setting Tool

Part No	Description	Size	Qty/Pk
GMFX111-100	Stud Hanger	M10 x 25mm	pk 100
GMFX112-100	Stud Hanger	M10 x 38mm	pk 100

Wood Fixing Horizontal Stud Hanger



**M8
Wood**

- An internally threaded socket for hanging rods in wood
- Inserted using the GMFX127-100 Setting Tool

Part No	Description	Size	Qty/Pk
GMFX124-100	Stud Hanger	M8 x 25mm	pk 100

Wood Fixing Horizontal Stud Hangers



**M10
Wood**

- An internally threaded socket for hanging rods in wood
- Inserted using the GMFX127-100 Setting Tool

Part No	Description	Size	Qty/Pk
GMFX125-100	Stud Hanger	M10 x 25mm	pk 100
GMFX126-100	Stud Hanger	M10 x 50mm	pk 100

Metal Fixing Horizontal Stud Hanger



**M8
Metal**

- An internally threaded socket for hanging rods in light section steel
- Inserted using the GMFX127-100 Setting Tool

Part No	Description	Size	Qty/Pk
GMFX113-100	Stud Hanger	M8 x 25mm	pk 100

Metal Fixing Horizontal Stud Hangers



**M10
Metal**

- An internally threaded socket for hanging rods in light section steel
- Inserted using the GMFX127-100 Setting Tool

Part No	Description	Size	Qty/Pk
GMFX115-100	Stud Hanger	M10 x 25mm	pk 100
GMFX116-100	Stud Hanger	M10 x 38mm	pk 100

Setting Tool for Screw Stud Hangers



For all driver bits see page 236

- A 3/8" socket drive for setting rod hangers

Part No	Description	Qty/Pk
GMFX127-100	Setting Tool for Stud Hanger	Each

Chemical Resin



- For fixing studding into brick and blockwork
- Use with standard silicone gun
- High load capacity
- Expansion free

Part No	Description	Size
GMFX118	Polyester Resin - Styrene Free	300ml

Wedge Anchors

STÖRNCH

- Internally threaded to be used with threaded stud or bolts
- Easy to install using a Wedge Anchor Punch
- Slotted sleeve and internal wedge component together facilitate easy setting and expansion
- M8 = 30mm long
- M10 = 40mm long



Part No	Description	Hole Size	Qty/Pk
GMFX10	M8 Wedge Anchor	10mm	pk 100
GMFX11	M10 Wedge Anchor	12mm	pk 100

Wedge Anchors c/w Rim

STÖRNCH

- Internally threaded to be used with threaded stud or bolts
- Easy to install using a Wedge anchor punch
- Slotted sleeve and internal wedge component together facilitate easy setting and expansion
- M8 = 30mm long
- M10 = 40mm long



Part No	Description	Hole Size	Qty/Pk
GMFX18	M8 Wedge Anchor c/w Rim	10mm	pk 100
GMFX12	M10 Wedge Anchor c/w Rim	12mm	pk 50

SDS Drill Bit with Stop

- Allows you to drill to the correct depth for wedge anchors every time
- Suitable for M8 wedge anchors (GMFX10 & GMFX18)
- Not for M10 wedge anchors



Part No	Description	Size
GMSD20	SDS Drill Bit c/w Stop	10.0mm x 30mm Depth

Wedge Anchor Punch

- For the manual installation of wedge anchors
- Ideal for rapid, repetitive installations



Part No	Description	Size	Qty/Pk
GMFX16	Wedge Anchor Punch	M8	Each
GMFX17	Wedge Anchor Punch	M10	Each

M8 Wedge Anchor Punch

M8

- Punch for M8 wedge anchors
- Complete with built in hand guard



Part No	Description	Size	Qty/Pk
GMWAP1	Wedge Anchor Punch	M8	Each

M10 Wedge Anchor Punch

M10

- Punch for M10 wedge anchors
- Complete with built in hand guard



Part No	Description	Size	Qty/Pk
GMWAP2	Wedge Anchor Punch	M10	Each

Wedge Nuts

STÖRNCH

- To suit ribbed and composite floor decking
- Fitted easily and securely by hand
- Zinc plated (BZP)

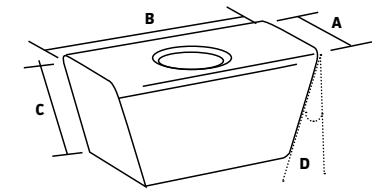

Part No	Description	Stud Size	DIM A	DIM B	DIM C	Angle D	Qty/Pk
GMFX75	Wedge Nuts	M8	12.5mm	25mm	13mm	15°	pk 100
GMFX76	Wedge Nuts	M10	12.5mm	25mm	13mm	15°	pk 100

Mini Wedge Nut

STÖRNCH

- To suit ribbed and composite floor decking
- Fitted easily and securely by hand
- Zinc plated (BZP)

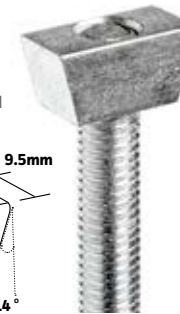
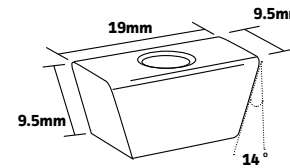

Part No	Description	Stud Size	Qty/Pk
GMFX150	Mini Wedge Nuts	M8	pk 100

Beam Clamp (Purlin Clip)

- For fixing to vertical flanges
- For threaded rod up to M10
- Suitable for a wide range of purlin sections



Part No	Description	Size	Qty/Pk
GMFX42	Beam Clamp (Purlin Clip)	M8/M10	Each

M8 Threaded Rod Hanger

- c/w threaded rod holder
- The rod height is adjustable by screwing up or down



Part No	Description	Size	Qty/Pk
GMFX49-100	Threaded Rod Hanger	M8	pk 100

Vertical Beam Clips

STÖRNCH

- For quick and easy fixing to vertical flanges
- The rod height is adjustable by screwing up or down



Part No	Description	Size	Qty/Pk
GMFX43-50	Vertical Beam Clips	M8	pk 50
GMFX44-50	Vertical Beam Clips	M10	pk 50

Lindapter TR60



- The Type TR60 is designed for TR60+ and TR80+ profiles manufactured by Structural Metal Decks
- Zinc plated (BZP)

Part No	Description	Size	Qty/Pk
GMFX163-50	Lindapter TR60	M8	pk 50
GMFX164-50	Lindapter TR60	M10	pk 50

Lindapter Alphawedge



- The Alphawedge is designed for Ribdeck E60 manufactured by Hare Decking
- Zinc plated (BZP)

Part No	Description	Size	Qty/Pk
GMFX160-50	Lindapter Alphawedge	M8	pk 50
GMFX161-50	Lindapter Alphawedge	M10	pk 50

Lindapter MW2 Multiwedge 2



- The Multiwedge 2 is designed for Multideck 60 and Multideck 80 profiles, manufactured by Kingspan Structural Products
- Zinc plated (BZP)

Part No	Description	Size	Qty/Pk
GMFX162-50	Lindapter MW2	M8	pk 50
GMFX48-50	Lindapter MW2	M10	pk 50

Flange Clamp



- Suitable for parallel or tapered flange beams
- Supplied with drilled hole for hanging studding

Part No	Description	Size	Qty/Pk
GMFX40	Flange Clamp	M8/M10	Each
GMFX41	Flange Clamp	M12	Each



Wire Ropes & Wire Rope Tool



- Cut to length wire rope system
- 6 times quicker to install than with strut and stud

Part No	Description	Size	Roll Length
GMVX106	No. 10 Wire Rope	50kg	100mt
GMVX107	No. 20 Wire Rope	120kg	100mt
GMVX112	Wire Rope Cutter		

Wire Rope Clutchers



- Simple system for rapid suspension of ductwork, cable tray, lighting & units etc
- Use GMVX101 - with No.10 Wire Rope
- Use GMVX102 - with No.20 Wire Rope

Part No	Description	Size	Qty/Pk
GMVX101	No. 10 Clutchers	50kg	pk 10
GMVX102	No. 20 Clutchers	120kg	pk 10

Wire Hanger



- Zinc and yellow passivated
- Drill a 6mm hole, to a minimum of 40mm depth
- Hammer-in, pull-down expansion
- Expansion anchor for securing suspension wires to concrete and most masonry

Part No	Description	Size	Qty/Pk
GMWH	Wire Hanger	6mm x 55mm	pk100

Zip-Clip Knock-in Anchor



- Hammer-in fixing
- Designed to fix wire suspension to cracked & non cracked concrete ceilings
- Drill a 6mm hole, to a minimum of 35mm depth
- BS8539 compliant

Part No	Description	Qty/Pk
GMVX120	Zip-Clip Knock-in Anchor	pk 50

Folded Eye Bolt



- A bolt with a loop at one end, used for light duty suspension applications including tensioning wire
- c/w nut
- Zinc plated (BZP)

Part No	Description	Size	Qty/Pk
GMFX136	Folded Eye Bolt	M8 x 80mm	Each

Cast Eye Bolt



- Suitable for a variety of applications, and designed to provide a multi-purpose circular fixture for tensioning wires, securing loads & lifting operations
- M8 threaded shaft

Part No	Description	Size	Qty/Pk
GMFX71	Cast Eye Bolt	M8	Each

Looped Gripple



- Ideal for looping around purlins, beams and roof trusses etc
- Comes as a ready-to-use kit with wire and Gripple clutches

Part No	Description	Size	Qty/Pk
GMVX37	No 2 Looped Gripple	1mt	pk 10
GMVX38	No 2 Looped Gripple	2mt	pk 10

Suspension Banding



- Easily cut and bent for hanging and supporting applications
- Pre-galvanised
- Multi-purpose fixing band

Part No	Description	Roll Size
GMVX30	Suspension Banding	17mm x 10mt

Black Patent Banding



- Pre-perforated for fixing using screws, nails or bolts
- Corrosion-resistant black plastic coating
- Easy to cut and bend for securing and supporting cable, trunking and ducting

Part No	Description	Roll Size
GMND	Round Black Patent Banding	12mm x 10mt

Black Hook & Loop Tape (Velcro)



- Makes re-adjustment of pipework effortless
- For permanent or temporary fixing
- Simply cut to any length
- Back-to-back hook and loop tape that fastens to itself

Part No	Description	Size
GMHL1625	Black Hook & Loop Tape	16mm x 25mt

Hose Banding & Locks



- 9mm continuously threaded stainless steel band
- Simply cut to any length

Part No	Description	Roll Size
GMVA1	Hose Banding	30mt Reel
GMVA2	Hose Banding Locks	pk 50

Quick Release Hose Clips



- Quick release for rapid application and removal

Part No	Description	Size
GMVA3	Quick Release Hose Clips	60mm - 180mm
GMVA4	Quick Release Hose Clips	60mm - 325mm

Rubber Ankernuts

STÖRNCH



- Suitable for anti-vibration and noise dampening in plasterboard, concrete, wood and potted ceilings

Part No	Description	Size	Hole Size	Qty/Pk
GMFX7-50	Rubber Ankernuts	M8 x 25mm	16mm	pk 50
GMFX8-50	Rubber Ankernuts	M8 x 50mm	18mm	pk 50
GMFX9-25	Rubber Ankernuts	M10 x 55mm	20mm	pk 25

Loose Bolt Shield Anchors

STÖRNCH



- For use in concrete, hollow-core slabs, flooring blocks and ceramics
- 10L = 10mm fixing capacity

Part No	Description	Size	Hole Size	Qty/Pk
GMFX1-25	Shield Anchors	M810L	14mm	pk 25
GMFX2-25	Shield Anchors	M1010L	16mm	pk 25

Projection Shield Anchors

STÖRNCH



10P = 10mm fixing capacity
15P = 15mm fixing capacity
60P = 60mm fixing capacity

- These operate in the same way as Loose Bolt Shield Anchors, but come with a projecting stud

Part No	Description	Size	Hole Size	Qty/Pk
GMFX3-25	Projection Shield Anchors	M810P	14mm	pk 25
GMFX4-25	Projection Shield Anchors	M1015P	16mm	pk 25
GMFX19	Projection Shield Anchors	M1060P	16mm	Each

Concrete Screws

STÖRNCH

- Completely removable, therefore suitable for temporary fixings
- Serrations on the thread make them easy to screw in
- Re-usability of the screw reduces cost
- Must be drilled to the correct depth

For all driver bits see page 236



Part No	Description	Size	Hole Size	Qty/Pk
GMFX110-100	Concrete Screw	6 x 50mm	5mm	pk 100
GMFX108-100	Concrete Screw	8 x 75mm	6mm	pk 100
GMFX109-100	Concrete Screw	10 x 75mm	8mm	pk 100

15mm head **GMFX109-100**
10mm head **GMFX108-100**
8mm head **GMFX110-100**

Hammer-In Plasterboard Fixings

STÖRNCH



- No drilling needed
- Anti-rotating design
- Hammer-in for medium applications
- Supplied with screws

Part No	Description	Qty/Pk
GMFX114	Hammer-In Plugs	pk 200

Aluminium Plasterboard Fixing

STÖRNCH



- Flange prevents accidental push through in plasterboard
- No drill required - simply pierce paper skin and screw home.
- Ideal for use with either a power or manual Pozidrive screwdriver
- Supplied with screws

Part No	Description	Qty/Pk
GMFX13	Aluminium Plasterboard Fixing	pk 100

Spring Toggles

STÖRNCH



- Cavity wall & plasterboard fixings
- GMFX45 for use with M8 studding

Part No	Description	Hole Size	Qty/Pk
GMFX15-50	M6x75mm Spring Toggles	18mm	pk 50
GMFX45	M8 Toggle Head Only	22mm	Each

Wall Plugs



- Two-way expansion mechanism provides a strong anchorage in solid base materials
- Red plugs for 8g screws
- Brown plugs for 10g screws

Part No	Description	Hole Size	Qty/Pk
GMFX37	Red Plugs	5.5mm	pk 100
GMFX38	Brown Plugs	7.0mm	pk 100

Nylon Plugs

STÖRNCH



- Heavily ribbed design improves pull-out strength
- Suitable for coach screws

Part No	Description	Hole Size	Qty/Pk
GMFX78	Nylon Plugs	10.0mm	pk 100

Hex Coach Screws

STÖRNCH



- Can be used with nylon plugs, or screwed directly into timber
- Zinc plated (BZP)

Part No	Description	Size	Qty/Pk
GMFX30	Hex Coach Screws	M8 x 60mm	pk 100

Bolt Screw



- Woodscrew thread at one end and machine screw thread at the other
- Zinc plated (BZP)

Part No	Description	Size	Qty/Pk
GMFX68	Bolt Screw	M8 x 80mm	Each

Self Drill Screws - Square Drive

STÖRNCH



- Self drill
- Self tapping
- Zinc plated (BZP)
- c/w driver bit

Part No	Description	Size	Qty/Pk
GMFX65	Square Drive Pan Head	4.2 x 13mm	pk 1000
GMFX67	Square Drive Pan Head	4.2 x 19mm	pk 1000
GMFX134	Square Driver Bit		Each

Countersunk Pozi Woodscrews

STÖRNCH



- A single thread woodscrew, mainly used in various types of timber and man-made boards, or in masonry with a plastic plug

Part No	Description	Imperial	Metric	Qty/Pk
GMFX20	Woodscrews	8 x 1"	4.0 x 25mm	pk 200
GMFX21	Woodscrews	8 x 1 ¼"	4.0 x 30mm	pk 200
GMFX22	Woodscrews	8 x 1 ½"	4.0 x 40mm	pk 200
GMFX23	Woodscrews	8 x 2"	4.0 x 50mm	pk 200
GMFX25	Woodscrews	10 x 1 ½"	5.0 x 40mm	pk 200
GMFX26	Woodscrews	10 x 2"	5.0 x 50mm	pk 200
GMFX27	Woodscrews	10 x 2 ½"	5.0 x 60mm	pk 200
GMFX101	Woodscrews	10 x 3"	5.0 x 80mm	pk 200
GMFX66	Woodscrews	10 x 4"	5.0 x 100mm	pk 100
GMH550	PZ2 Impact Driver Bits			pk 10

Self Drill Screws - Wafer Head

STÖRNCH



- Self drill
- Self tapping
- Zinc plated (BZP)
- c/w driver bit

Part No	Description	Size	Qty/Pk
GMFX190	Self Drill Screws - Phillips	4.2 x 13mm	pk 1000
GMFX192	Self Drill Screws - Phillips	4.2 x 25mm	pk 1000

Self Drill Screws - Hex Head

STÖRNCH



- Self drill
- Self tapping
- Zinc plated (BZP)
- Driver Bit sold separately (GMFX35)

Part No	Description	Size	Qty/Pk
GMFX102	Self Drill Hex Head	4.2 x 13mm	pk 1000
GMFX34	Self Drill Hex Head	4.2 x 19mm	pk 1000
GMFX35	Magnetic Hex Driver Bit	7mm	Each