



GREENMILL

IN STOCK ON SITE ON TIME

IN STOCK
VERSION

05

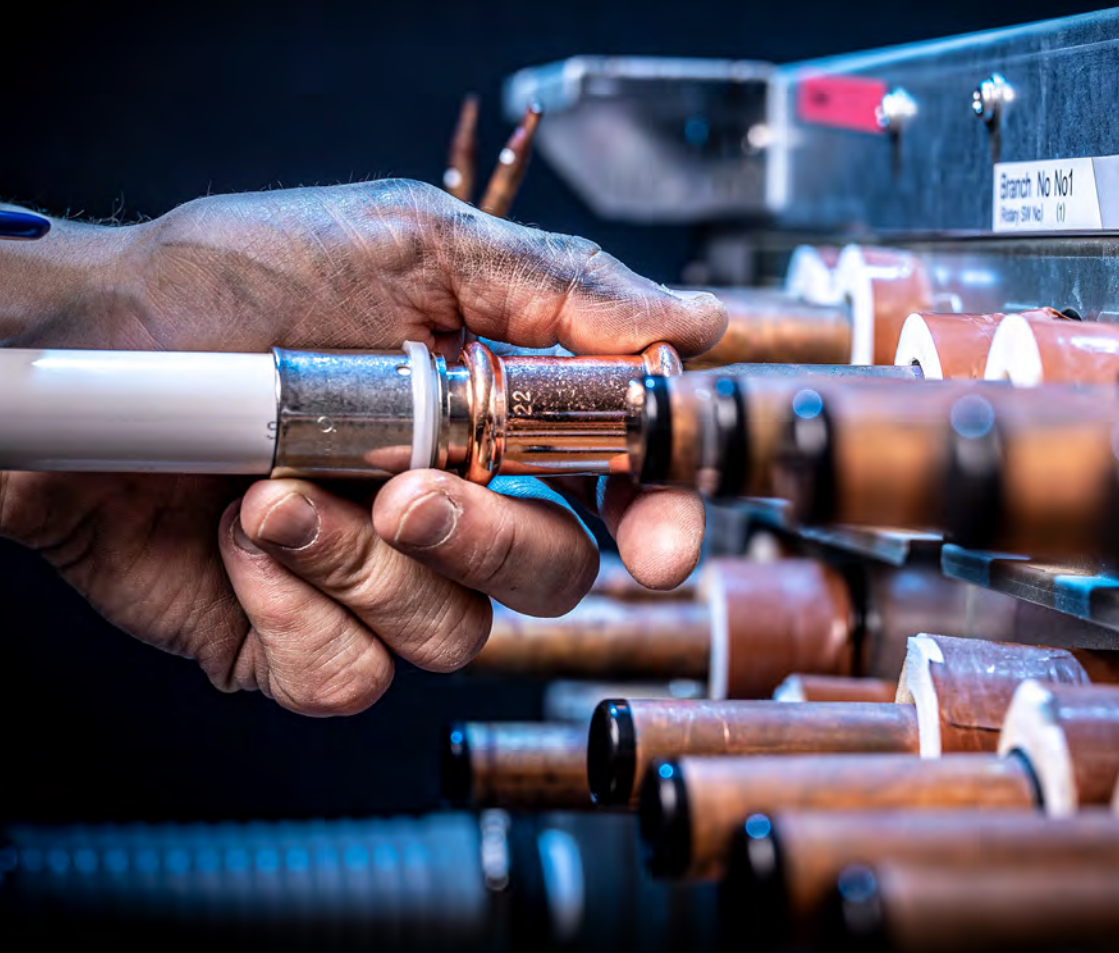

HYBRIDHUB

PRESSFIT & HYBRID VRF INSTALL MATERIALS

Ordering Pressfit and HVRF install materials has never been easier, with our in-stock **Hybrid Hub catalogue, Version 5.**

Our latest Version 5 Hybrid Hub catalogue brings all of Greenmill's comprehensive range of Pressfit and HVRF install materials together into a handy, pocket-sized catalogue.

Spread over 40+ bumper pages, this supplement is one of the few catalogues to feature both RLS (Rapid Locking System) and Conex >B< MaxiPro, the UK's two leading braze-free pressfit systems, along

with the increasingly popular STÖRNCH Barrier Press and Copper Press systems.

Version 5 includes a wide range of in-stock fittings, tools, jaw sets, accessories and pressfit ancillaries, all with next-day delivery as standard. Plus, if you need a bit of guidance with your installs, check out the free Hybrid schematics at the back of the catalogue, or get in touch with our specialist Hybrid Hub team.

01206 864 467 or order online at:
www.greenmillac.com



CHRIS TAME
 Head of Sales



SIMON MAKIN
 Pressfit & Hybrid
 Specialist



In this catalogue:

Resources & Information	4-5
PRESSFIT SOLUTIONS	
RLS Braze-Free Pressfit Tool, Jaws & Accessories	6-8
RLS Braze-Free Fittings	9-10
Conex MaxiPro Pressfit Tool, Jaws & Accessories	11-12
Conex MaxiPro Fittings	13-15
Pressfit Ancillaries	16
HYBRID VRF INSTALL MATERIALS	
Hybrid Barrier Pipe & Fittings	18-20
Armaflex Class 'O' Lagging for Barrier Pipe	21
Weatherproof Lagging & Accessories	22
Hybrid Barrier Pipe Tools	23-24
Hybrid Barrier Pipe Push Fit Fittings	25
Hybrid Copper Press Fittings	26-27
Hybrid Compression Fittings	28-29
Hybrid Water Supply	30-31
PIPEWORK INSTALLATION & GUIDES	32-33
HVRF Pipework Connection Schematic Drawings	34-47

HYBRIDHUB

PRESSFIT & HYBRID VRF INSTALL MATERIALS

The leading resource for all things Pressfit & Hybrid: www.pressfitsolutions.com

- Training Videos
- Technical Advice
- Certification

Whether you're an experienced user looking for the latest technical info, or you're new to the technologies and need to find out more, our specialist Hybrid Hub site pressfitsolutions.com provides a one-stop-shop for all your pressfit and hybrid requirements.

Greenmill has been involved with pressfit and hybrid systems since 2017, working closely with leading manufacturers and early adopters, to help establish the technology within the UK. Over that period we've gained a huge amount of specialist knowledge and experience, which we've now squeezed into pressfitsolutions.com, the leading resource for all things pressfit and hybrid.

There's a whole section of easy-to-follow training videos, delivered by our Pressfit & Hybrid specialist, Simon Makin. And you can register for certification and increase your warranty on some systems. You'll also find detailed technical specifications, downloadable installation guides, tool and fitting lists, plus links to online ordering. So if you need to know anything about pressfit or hybrid, go to: pressfitsolutions.com



Pressfit Solutions

Do you rave about RLS, or are you part of the MAXIPRO mob? Whatever your preferred pressfit system, we've got all the tools, fittings, ancillaries and knowledge you need.

Choosing between RLS and Conex >B< MaxiPro is always going to be tough. They're both solid pressfit systems that are fast, easy-to-use and produce a leak-free joint without brazing. So we decided to give you the choice and stock them both. In fact we are one of the few install materials suppliers to stock the UK's two leading braze-free jointing systems.

If you want to create permanent leak-free joints in seconds, improving your productivity and significantly reducing installation time, our braze-free pressfit range includes everything you need.

Contact our specialist team to find out more, or order online at: greenmillac.com/pressfit-jointing



RLS 19kN Press Tool Kit

This RLS tool kit is a universal kit for both Hybrid and Braze-free refrigeration jointing systems

Purchase this press tool kit and then simply buy the jaws as and when you need them. Add Makita charger and battery if required

Startup Kit Includes:

- 19kN RLS Crimping Tool
- Tube Cutter
- Deburring Tool
- Crimp Gauge
- Depth Gauge
- Stainless Steel Brush
- Abrasive Pad
- Permanent Marker



No jaws, batteries or charger included

Part No	Description
GMZLTOOL138-NB	19kN RLS Press Tool Kit & Case

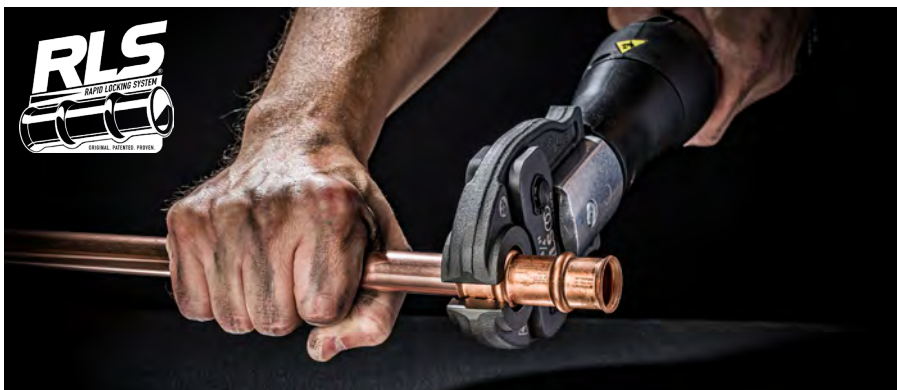

Makita 18V Fast Charger



- Extremely fast charging time

Part No	Description
GMZLCHAR	Makita 18v Battery Charger

Makita 18V Battery



- High performance rechargeable battery

Part No	Description
GMZLBAT15	Makita 18v Rechargeable Battery

19kN RLS Jaws



- Patented concentric crimping jaws
- Applies perfectly even pressure all around the 'o-ring' and copper tube

- Compatible with the 19kN RLS and Rothenberger press tools

Part No	Description	Size
GMZL231	RLS Jaw	¼"
GMZL232	RLS Jaw	¾"
GMZL233	RLS Jaw	½"
GMZL234	RLS Jaw	¾"

Part No	Description	Size
GMZL235	RLS Jaw	¾"
GMZL236	RLS Jaw	¾"
GMZL237	RLS Jaw	1-¾"
GMZL238	RLS Jaw	1-¾"

Copper M Press Fit Jaws



- For copper pressfit system
- 15kN Jaws compatible with 15kN press tool
- 19kN Jaws compatible with the 19kN RLS & Rothenberger press tools
- M-Profile

Part No	Description	Capacity	Size
GMCPJ16	Copper Pressfit Jaw	15kN	15mm
GMCPJ23	Copper Pressfit Jaw	15kN	22mm
GMCPJ29	Copper Pressfit Jaw	15kN	28mm
GMCPJ15	Copper Pressfit Jaw	19kN	15mm
GMCPJ22	Copper Pressfit Jaw	19kN	22mm
GMCPJ28	Copper Pressfit Jaw	19kN	28mm
GMCPJ35	Copper Pressfit Jaw	19kN	35mm

Barrier Pipe Pressfit Jaws



- For barrier pressfit system
- 15kN Jaws compatible with 15kN press tool
- 19kN Jaws compatible with the 19kN RLS & Rothenberger press tools
- U-Profile

Part No	Description	Capacity	Size
GMUPJ21	Barrier Pressfit Jaw	15kN	20mm
GMUPJ25	Barrier Pressfit Jaw	15kN	25mm
GMUPJ33	Barrier Pressfit Jaw	15kN	32mm
GMUPJ20	Barrier Pressfit Jaw	19kN	20mm
GMUPJ26	Barrier Pressfit Jaw	19kN	25mm
GMUPJ32	Barrier Pressfit Jaw	19kN	32mm
GMUPJ40	Barrier Pressfit Jaw	19kN	40mm

Carry Case for RLS Jaws



Part No	Description
GMZL209	Carry Case for RLS Jaws



- Hard plastic case with foam lining
- Protective storage for full set of 8 jaws (jaws not included)

Deburring Tool



- Removes any internal or external burrs from copper tube
- RLS approved

Part No	Description
GMZL007	Deburring Tool

Abrasive Pad & Marker Pen



- Abrasive pad for cleaning the copper tubing prior to crimping
- Marks on most surfaces
- Use with the insertion depth gauge to mark the tube

Part No	Description	Qty/Pk
GMZL020	Abrasive Pad	Each
GMPMP	Permanent Marker Pen	pk 6

RLS Crimp Gauge



- Confirms the measurement of the finished crimp band diameter

Part No	Description
GMZL005	RLS Crimp Gauge

RLS Insertion Depth Gauge



- Confirms the proper insertion depth of the tubing

Part No	Description
GMZL014	RLS Insertion Depth Gauge

RLS Connectors



- For joining refrigeration copper tubes

Part No	Description	Size	Qty/Pk
GMZL501-10	RLS Connector	1/4"	pk 10
GMZL502-10	RLS Connector	3/8"	pk 10
GMZL503-10	RLS Connector	1/2"	pk 10
GMZL504-10	RLS Connector	5/8"	pk 10
GMZL505-10	RLS Connector	3/4"	pk 10
GMZL506-10	RLS Connector	7/8"	pk 10
GMZL507-10	RLS Connector	1-1/8"	pk 10
GMZL508-12	RLS Connector	1-3/8"	pk 12

RLS 45° Elbows

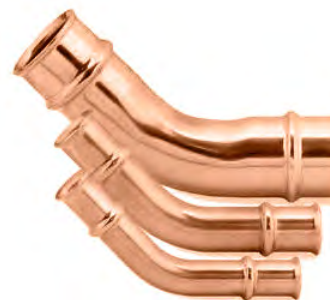

- For joining refrigeration copper tubes

Part No	Description	Size
GMZL402	RLS 45° Long Radius Elbow	3/8"
GMZL403	RLS 45° Long Radius Elbow	1/2"
GMZL404	RLS 45° Long Radius Elbow	3/4"
GMZL405	RLS 45° Long Radius Elbow	1"
GMZL406	RLS 45° Long Radius Elbow	1-1/4"
GMZL407	RLS 45° Long Radius Elbow	1-1/2"
GMZL408	RLS 45° Long Radius Elbow	1-3/4"

RLS 90° Long Radius Elbows



- For joining refrigeration copper tubes

Part No	Description	Size
GMZL601	RLS 90° Long Radius Elbow	1/4"
GMZL602	RLS 90° Long Radius Elbow	3/8"
GMZL603	RLS 90° Long Radius Elbow	1/2"
GMZL604	RLS 90° Long Radius Elbow	5/8"
GMZL605	RLS 90° Long Radius Elbow	3/4"
GMZL606	RLS 90° Long Radius Elbow	7/8"
GMZL607	RLS 90° Long Radius Elbow	1-1/8"
GMZL608	RLS 90° Long Radius Elbow	1-3/8"

RLS Euro Flare Fittings



- For connecting to flare unions

Part No	Description	Size
GMZL1001	RLS Euro Flare Fitting	1/4" SAE
GMZL1002	RLS Euro Flare Fitting	3/8" SAE
GMZL1003	RLS Euro Flare Fitting	1/2" SAE
GMZL1004	RLS Euro Flare Fitting	3/4" SAE

RLS End Caps



- For capping the ends of refrigeration copper tubes

Part No	Description	Size
GMZL901	RLS End Cap	¼"
GMZL902	RLS End Cap	⅜"
GMZL903	RLS End Cap	½"
GMZL904	RLS End Cap	⅝"
GMZL905	RLS End Cap	¾"
GMZL906	RLS End Cap	⅞"
GMZL907	RLS End Cap	1-¼"
GMZL908	RLS End Cap	1-⅜"

RLS Equal Tees



- For joining refrigeration copper tubes

Part No	Description	Size
GMZL702	RLS Equal Tee	⅜"
GMZL703	RLS Equal Tee	½"
GMZL704	RLS Equal Tee	⅝"
GMZL705	RLS Equal Tee	¾"
GMZL706	RLS Equal Tee	⅞"
GMZL707	RLS Equal Tee	1-¼"
GMZL708	RLS Equal Tee	1-⅜"

RLS Reducing Couplings

Part No	Description	Size
GMZL800	RLS Reducing Coupling	⅝"-¾" C x C
GMZL808	RLS Reducing Coupling	¾"-¾" C x C
GMZL801	RLS Reducing Coupling	¾"-¾" C x C
GMZL809	RLS Reducing Coupling	⅝"-¾" C x C
GMZL810	RLS Reducing Coupling	⅝"-¾" C x C
GMZL802	RLS Reducing Coupling	¾"-¾" C x C
GMZL811	RLS Reducing Coupling	¾"-¾" C x C
GMZL803	RLS Reducing Coupling	¾"-¾" C x C
GMZL812	RLS Reducing Coupling	⅞"-¾" C x C
GMZL804	RLS Reducing Coupling	⅞"-¾" C x C
GMZL805	RLS Reducing Coupling	⅞"-¾" C x C
GMZL813	RLS Reducing Coupling	1-¼"-¾" C x C
GMZL814	RLS Reducing Coupling	1-¼"-¾" C x C
GMZL806	RLS Reducing Coupling	1-¼"-¾" C x C
GMZL807	RLS Reducing Coupling	1-¼"-¾" C x C
GMZL818	RLS Reducing Coupling	1-¾"-¾" C x C
GMZL819	RLS Reducing Coupling	1-¾"-¾" C x C



- For joining refrigeration copper tubes

Rothenberger Romax Compact Tool Set c/w Jaws & Accessories

This Rothenberger tool kit is a universal kit for both Hybrid and Braze-free refrigeration jointing systems



- Startup Kit Includes:
- 19kN Press Tool
- Tube Cutter
- Deburring Tool
- Deburring Pencil
- Depth Gauge
- Abrasive Pads
- Permanent Marker
- 18v Battery
- Charger
- Rothenberger set of 8 Jaws 1/4" - 1-1/8" to suit >B< MaxiPro fittings
- Sizes include: 1/4", 3/8", 1/2", 5/8", 3/4", 7/8", 1", 1-1/8"
- 2x Stackable Carry Cases

Part No	Description
GM CXM8	Romax Compact Tool Set with Jaws



Romax Compact Tool Set c/w Battery & Charger (No Jaws)



- 19kN Press Tool
- 18V Battery
- Battery Charger
- Stackable Carry Case

Part No	Description
GMCXM0	Romax Compact Tool Set (No Jaws)

Conex MaxiPro 8 Jaw Set



- Rothenberger set of 8 Jaws 1/4" - 1-1/8" in a stackable carry case to suit MaxiPro fittings
- Sizes include: 1/4", 3/8", 1/2", 5/8", 3/4", 7/8", 1", 1-1/8"

Part No	Description	Size Range
GMCX8JS	Conex MaxiPro Set of 8 Jaws	1/4" - 1 1/8"

** MaxiPro Straight Couplers**



- Suitable for air-conditioning and refrigeration applications up to 48 bar

Part No	Description	Size	Qty/Pk
GMCXSC14	Straight Couplers	1/4"	pk5
GMCXSC38	Straight Couplers	3/8"	pk5
GMCXSC12	Straight Couplers	1/2"	pk5
GMCXSC58	Straight Couplers	3/4"	pk5
GMCXSC34	Straight Couplers	3/4"	pk2
GMCXSC78	Straight Couplers	7/8"	pk2
GMCXSC118	Straight Couplers	1-1/8"	pk2

** MaxiPro 45° Elbows**



- Suitable for air-conditioning and refrigeration applications up to 48 bar

Part No	Description	Size	Qty/Pk
GMCX45B14	45° Elbows	1/4"	pk3
GMCX45B38	45° Elbows	3/8"	pk3
GMCX45B12	45° Elbows	1/2"	pk3
GMCX45B58	45° Elbows	3/4"	pk3
GMCX45B34	45° Elbows	3/4"	pk3
GMCX45B78	45° Elbows	7/8"	pk3
GMCX45B118	45° Elbows	1-1/8"	pk2

** MaxiPro 90° Long Radius Elbows**



- Suitable for air-conditioning and refrigeration applications up to 48 bar

Part No	Description	Size	Qty/Pk
GMCX90B14	90° Long Radius Elbows	1/4"	pk5
GMCX90B38	90° Long Radius Elbows	3/8"	pk5
GMCX90B12	90° Long Radius Elbows	1/2"	pk3
GMCX90B58	90° Long Radius Elbows	3/4"	pk3
GMCX90B34	90° Long Radius Elbows	3/4"	pk3
GMCX90B78	90° Long Radius Elbows	7/8"	pk3
GMCX90B118	90° Long Radius Elbows	1-1/8"	pk2

** MaxiPro 90° Street Bends**



- Suitable for air-conditioning and refrigeration applications up to 48 bar

Part No	Description	Size	Qty/Pk
GMCXS90B38	90° Street Bends	3/8"	pk3
GMCXS90B12	90° Street Bends	1/2"	pk3
GMCXS90B58	90° Street Bends	3/4"	pk3
GMCXS90B34	90° Street Bends	3/4"	pk3
GMCXS90B78	90° Street Bends	7/8"	pk3
GMCXS90B118	90° Street Bends	1-1/8"	pk2

Rothenberger Compact Battery



- Patented "AIR COOLED" charging technology
- Processor-controlled charging management system
- Capacity indicator to control the charging level

Part No	Description
GMCXBAT	Rothenberger 18V Spare Battery

Conex MaxiPro Depth Gauge



- MaxiPro depth gauge with marker pen to confirm the proper insertion depth of the tubing into the fittings

Part No	Description
GMCXDG	Conex MaxiPro Depth Gauge & Marker

** MaxiPro Stop Ends**



- Suitable for air-conditioning and refrigeration applications up to 48 bar

Part No	Description	Size	Qty/Pk
GMCXSE14	Stop Ends	¼"	pk3
GMCXSE38	Stop Ends	¾"	pk3
GMCXSE12	Stop Ends	½"	pk3
GMCXSE58	Stop Ends	¾"	pk2
GMCXSE34	Stop Ends	¾"	pk2
GMCXSE78	Stop Ends	¾"	pk2
GMCXSE118	Stop Ends	1-½"	pk1

** MaxiPro Equal Tees**



- Suitable for air-conditioning and refrigeration applications up to 48 bar

Part No	Description	Size	Qty/Pk
GMCXET14	Equal Tees	¼"	pk3
GMCXET38	Equal Tees	¾"	pk3
GMCXET12	Equal Tees	½"	pk3
GMCXET58	Equal Tees	¾"	pk2
GMCXET34	Equal Tees	¾"	pk2
GMCXET78	Equal Tees	¾"	pk2
GMCXET118	Equal Tees	1-½"	pk1

** MaxiPro Reducing Couplers**



- Suitable for air-conditioning and refrigeration applications up to 48 bar

Part No	Description	Size	Qty/Pk
GMCXRC1238	Reducing Couplers	½"-¾"	pk2
GMCXRC5838	Reducing Couplers	¾"-¾"	pk2
GMCXRC5812	Reducing Couplers	¾"-½"	pk2
GMCXRC3438	Reducing Couplers	¾"-¾"	pk2
GMCXRC3412	Reducing Couplers	¾"-½"	pk2
GMCXRC3458	Reducing Couplers	¾"-¾"	pk2

Part No	Description	Size	Qty/Pk
GMCXRC7812	Reducing Couplers	¾"-½"	pk2
GMCXRC7858	Reducing Couplers	¾"-¾"	pk2
GMCXRC7834	Reducing Couplers	¾"-¾"	pk2
GMCXRC11858	Reducing Couplers	1-¾"-¾"	pk1
GMCXRC11834	Reducing Couplers	1-¾"-¾"	pk1
GMCXRC11878	Reducing Couplers	1-¾"-¾"	pk1

** MaxiPro Fitting Reducers**



- Suitable for air-conditioning and refrigeration applications up to 48 bar
- For reducing fittings

Part No	Description	Size	Qty/Pk
GMCXFR3814	Fitting Reducers	¾"-¾"	pk2
GMCXFR1238	Fitting Reducers	½"-¾"	pk2
GMCXFR5838	Fitting Reducers	¾"-¾"	pk2
GMCXFR5812	Fitting Reducers	¾"-½"	pk2
GMCXFR3412	Fitting Reducers	¾"-½"	pk2
GMCXFR3458	Fitting Reducers	¾"-¾"	pk2
GMCXFR7812	Fitting Reducers	¾"-½"	pk2

Part No	Description	Size	Qty/Pk
GMCXFR7858	Fitting Reducers	¾"-¾"	pk2
GMCXFR7834	Fitting Reducers	¾"-¾"	pk2
GMCXFR11812	Fitting Reducers	1-¾"-½"	pk1
GMCXFR11858	Fitting Reducers	1-¾"-¾"	pk1
GMCXFR11834	Fitting Reducers	1-¾"-¾"	pk1
GMCXFR11878	Fitting Reducers	1-¾"-¾"	pk1

** MaxiPro Flare Adapters**



- Suitable for air-conditioning and refrigeration applications up to 48 bar

Part No	Description	Size	Qty/Pk
GMCXFA14	Flare Adapters	¼"	pk4
GMCXFA38	Flare Adapters	¾"	pk4
GMCXFA12	Flare Adapters	½"	pk2
GMCXFA58	Flare Adapters	¾"	pk2
GMCXFA34	Flare Adapters	¾"	pk2



Pressfit Liquid Line Filter Driers



- These have plain copper tails that can be crimped directly onto, making them press fit compatible

Part No	Description	Size	Qty/Pk
GMZL909	Liquid Line Filter Drier	3/8"	Each
GMZL910	Liquid Line Filter Drier	1/2"	Each

Pressfit Y Joints

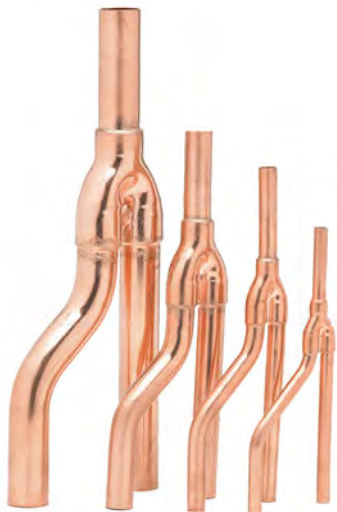

- Y Joints are part of our range of ancillary products for press fitting. These have plain copper tails which makes them press fit compatible

Part No	Description	Size	Qty/Pk
GMZL917	Pressfit Y Joints	3/8"	Each
GMZL918	Pressfit Y Joints	1/2"	Each
GMZL919	Pressfit Y Joints	3/4"	Each
GMZL920	Pressfit Y Joints	1"	Each
GMZL921	Pressfit Y Joints	1 1/8"	Each
GMZL922	Pressfit Y Joints	1 1/2"	Each
GMZL923	Pressfit Y Joints	1 3/4"	Each

Pressfit P Traps



- These have plain copper tails that can be crimped directly onto, making them press fit compatible

Part No	Description	Size	Qty/Pk
GMZL911	Pressfit P traps	1/2"	Each
GMZL912	Pressfit P traps	3/4"	Each
GMZL913	Pressfit P traps	1"	Each
GMZL914	Pressfit P traps	1 1/8"	Each
GMZL915	Pressfit P traps	1 1/2"	Each
GMZL916	Pressfit P traps	1 3/4"	Each

Pressfit Ball Valves c/w Schrader



- Ball Valves with Schraders are part of our range of ancillary products for press fitting. These have plain copper tails which makes them press fit compatible

Part No	Description	Size	Qty/Pk
GMZL924	Pressfit Ball Valves	1/2"	Each
GMZL925	Pressfit Ball Valves	3/4"	Each
GMZL926	Pressfit Ball Valves	1"	Each
GMZL927	Pressfit Ball Valves	1 1/8"	Each
GMZL928	Pressfit Ball Valves	1 1/2"	Each
GMZL929	Pressfit Ball Valves	1 3/8"	Each
GMZL930	Pressfit Ball Valves	1 1/2"	Each
GMZL931	Pressfit Ball Valves	1 3/4"	Each

Hybrid VRF Install Materials

At Greenmill, we like to think of ourselves as Hybrid VRF specialists. Which is why we are confident we've got everything you need for your hybrid installs.

Not every AC install materials supplier will stock Hybrid Water Supply components for instance. But, because we understand hybrid, we have a specialist section on our website just for that. Plus, there's Barrier Press, Push Fit, Copper Press, tools, hybrid

components and consumables. Remember, if it's in our Hybrid Hub catalogue, it's in-stock and available for next-day delivery.

Whether it's your first HVRF job, or you simply have a quick spec question, get in touch with our specialist team for all the technical advice, support and materials you need on your next hybrid install. Or order online now at:

www.greenmillac.com/hybrid-materials



Barrier Pipe - Straight Lengths

STÖRNCH

For Class 'O' Insulation See pages 76 & 78



- Multilayer pipe with aluminium
- WRAS approved
- 50 year life expectancy
- -40°C to +95°C working temperatures

Part No	Description	Size OD	Length
GMUP106	Straight Barrier Pipe	20mm Ø	5mt
GMUP102	Straight Barrier Pipe	25mm Ø	3.9mt
GMUP103	Straight Barrier Pipe	32mm Ø	3.9mt
GMUP104	Straight Barrier Pipe	40mm Ø	3.9mt

Coiled Barrier Pipes

STÖRNCH

For Class 'O' Insulation See pages 76 & 78



- Multilayer pipe with aluminium
- WRAS approved
- 50 year life expectancy
- -40°C to +95°C working temperatures

Part No	Description	Size OD	Length
GMUP107	Coiled Barrier Pipe	20mm Ø	100mt
GMUP100	Coiled Barrier Pipe	25mm Ø	50mt
GMUP105	Coiled Barrier Pipe	32mm Ø	50mt

Pre-Insulated Coiled Barrier Pipes & Tape

Part No	Description	Size OD	Wall Size
GMUP108	Pre-insulated Coiled Barrier Pipe	20mm Ø x 50mt	13mm
GMUP110	Pre-insulated Coiled Barrier Pipe	25mm Ø x 50mt	9mm
GMUP120	Pre-insulated Coiled Barrier Pipe	25mm Ø x 50mt	13mm
GMUP130	Pre-insulated Coiled Barrier Pipe	32mm Ø x 50mt	9mm
GMUP140	Pre-insulated Coiled Barrier Pipe	32mm Ø x 50mt	13mm
GMT2BLU	Blue PVC Tape	50mm x 33mt	

STÖRNCH

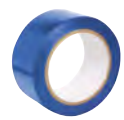

- WRAS approved Multilayer pipe with aluminium
- 50 year life expectancy
- -40°C to +95°C working temperatures
- For Class 'O' Lagging, see page 21
- Perfect for taping the Pre-Insulated Hybrid Barrier Pipe joints

Barrier Press Fit Straight Couplers

STÖRNCH



- For connecting Barrier Pipe together

Part No	Description	Size	Qty/Pk
GMUP4	Press Fit Straight Couplers	20mm Ø	pk 5
GMUP1	Press Fit Straight Couplers	25mm Ø	pk 5
GMUP2	Press Fit Straight Couplers	32mm Ø	pk 5
GMUP3	Press Fit Straight Couplers	40mm Ø	pk 5

Barrier Press Fit 90° Bends

STÖRNCH



- For connecting Barrier Pipe together

Part No	Description	Size	Qty/Pk
GMUP10	Press Fit 90° Bends	20mm Ø	pk 5
GMUP11	Press Fit 90° Bends	25mm Ø	pk 5
GMUP12	Press Fit 90° Bends	32mm Ø	pk 5
GMUP13	Press Fit 90° Bends	40mm Ø	pk 5

Barrier Press Fit Tees

- For connecting Barrier Pipe to Hybrid products with a 1/2" male thread
- Used in conjunction with AAV's, drain off cocks, pressure gauges and manual air vents
- GMPC254 required when using GMUP67



Part No	Description	Size	Qty/Pk
GMUP63	Press Fit Tees	20 x 20 x 1/2" FT	pk 5
GMUP65	Press Fit Tees	25 x 25 x 1/2" FT	pk 5
GMUP66	Press Fit Tees	32 x 32 x 1/2" FT	pk 5
GMUP67	Press Fit Tees	40 x 40 x 3/4" FT	pk 5
GMPC254	Brass Hex Bush	3/8" MT x 1/2" FT	each

Barrier Press Fit Equal Tee

STÖRNCH



- For connecting 25mm Ø Barrier Pipe together

Part No	Description	Size	Qty/Pk
GMUP31	Press Fit Equal Tees	25mm Ø	pk 10

Barrier Press Fit Male Adapters

STÖRNCH



- For connecting Barrier Pipe to Hybrid fan coil units

Part No	Description	Size	Qty/Pk
GMUP50	Press Fit Male Adapters	20mm Ø x 3/4"	pk 5
GMUP51	Press Fit Male Adapters	25mm Ø x 3/4"	pk 5
GMUP52	Press Fit Male Adapters	32mm Ø x 1-3/4"	pk 5
GMUP54	Press Fit Male Adapters	40mm Ø x 1-3/4"	pk 5

Barrier Press Fit Female Adapter

STÖRNCH



- For connecting 25mm Ø Barrier Pipe to fittings with 3/4" male threads

Part No	Description	Size	Qty/Pk
GMUP53	Press Fit Female Adapters	25mm Ø x 3/4"	pk 5

Copper Press Fit to Barrier Press Fit Adapters

- Used as a popular way to come off the HBC stubs
- Excellent for converting from 22mm copper pipe to barrier pipe
- We recommend using a GMCP2 22mm copper press fit coupling to connect this fitting to copper tube



STÖRNCH

Part No	Description	Size	Qty/Pk
GMUP79	Press Fit to Copper Press Adapter	20mm Ø x22mm Ø	Pk5
GMUP80	Press Fit to Copper Press Adapter	25mm Ø x22mm Ø	Pk5
GMUP81	Press Fit to Copper Press Adapter	32mm Ø x22mm Ø	Pk5

Copper Compression to Barrier Press Fit Adapters



STÖRNCH

- Used for connecting 22mm copper tube to barrier pipe
- It has a compression fitting one end, and a press fit at the other

Part No	Description	Size
GMHPF71	Copper to Barrier Press Fit / Compression Adapter	22mm to 25mm
GMHPF72	Copper to Barrier Press Fit / Compression Adapter	22mm to 32mm

Barrier Press Fit Reducers



- For connecting 32mm to 25mm barrier pipe (GMUP3225)
- For connecting 40mm to 25mm barrier pipe (GMUP4025)

Part No	Description	Size	Qty/Pk
GMUP3225	Press Fit Reducers	32mm Ø x25mm Ø	Pk5
GMUP4025	Press Fit Reducers	40mm Ø x25mm Ø	Pk5

Barrier Press Fit Lever Ball Valves



STÖRNCH

- Used for isolating Hybrid barrier press pipework

Part No	Description	Size
GMUP40	Barrier Press Fit Lever Ball Valve	20mm Ø
GMUP41	Barrier Press Fit Lever Ball Valve	25mm Ø
GMUP42	Barrier Press Fit Lever Ball Valve	32mm Ø
GMUP43	Barrier Press Fit Lever Ball Valve	40mm Ø



Class 'O' Lagging for Barrier Pipe



- Including - 2mt Lengths, & Boxed Coils
- Built-in anti-microbial protection inhibits the growth of mould and bacteria
- Offers an effective additional line of defence against the growth of microbes
- Anti-microbial agents provide protection for the life of the insulation
- Built-in vapour barrier prevents condensation
- Reduce energy losses up to 87%
- Excellent resistance to the effects of ozone, oil and chemicals



Class 'O' Insulation for Barrier Pipe



- Box quantity varies according to insulation size

Part No	Description	Pipe Size	Wall Size	Lengths/Box
GMEU22	2mt Straights	20mm	½"	56
GMEUH1325	2mt Straights	25mm	½"	42
GMEU25	2mt Straights	32mm	½"	30
GMEU26	2mt Straights	40mm	½"	28

Class 'O' Lagging for Barrier Pipe



Part No	Description	Pipe Size	Wall Size	Metres/Box
GMEU10	Boxed Coils	20mm	½"	28mt
GMEUC1325	Boxed Coils	25mm	½"	20mt

Lagging Tapes

STÖRNCH



- A closed cell Nitrile butadiene rubber blend with a high-strength acrylic adhesive on one side, reinforced with a scrim backing
- Excellent for applications in taping joints on Class '0' pipe insulation, along with the surfaces of seaming parts for tubes and rolls to reinforce the insulation systems
- Provides a fast and easy insulating method which can be conveniently applied on both irregular surfaces and in narrow working spaces

Part No	Description	Size	Qty/Box
GMEU30	STÖRNCH Lagging Tape	3mmx50mmx15mt	12
GMEU35	Armaflex Lagging Tape	3mmx50mmx15mt	12

Armaflex Lagging Adhesive

armacell



Armaflex adhesive recommended for every joint

- Armaflex 520 Adhesive is a thin yellow glue for use with Armaflex insulation
- Specially formulated to create uniform and safe bonding of seams and butt joints, and for sticking Armaflex to clean metal surfaces
- Easy to apply, and fast drying; speeding up the installation
- The wide spanning temperatures that this adhesive can withstand, makes it suitable for a range of commercial and industrial applications
- c/w application brush

Part No	Description	Size
GMEU31	Armaflex Adhesive	250ml

PVC Coated Weatherproof Lagging & Tape for Barrier Pipe

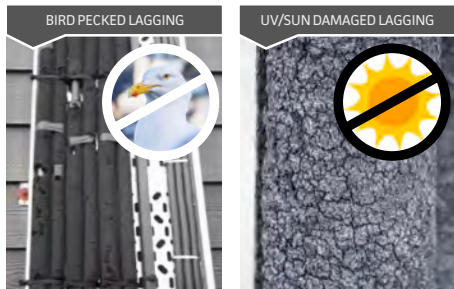

- PVC Coated External Grade Insulation
- External pipework needs to be insulated in a tough PVC coated weather protected covering to avoid UV degradation and animal damage.

Part No	Description	Pipe Size	Wall Size
GMVI22	PVC Coated 2mt Straights	20mm	½"
GMVIH1325	PVC Coated 2mt Straights	25mm	½"
GMVI25	PVC Coated 2mt Straights	32mm	½"
GMT2	Black PVC Tape	50mm x 33mt	



- For jointing weatherproof insulation

Part No	Description	Size	Qty
GMITAPE	PVC Coated Adhesive Tape	50mm x 250mm	pk10

Rothenberger Barrier Pipe Cutter



Part No	Description	Size
GMDFPC2	Rothenberger Plastic Pipe Cutter	≤42mm

- 2 Stage pipe holder for cutting 0 - 20 & 20 - 42mm pipes
- Instant-release mechanism for minimal effort
- For precise cutting without deformation
- Direct & ratchet modes

Barrier Pipe Bevelling Tools



Part No	Description	Size
GMUP209	Barrier Pipe Bevelling Tool	20mm
GMUP210	Barrier Pipe Bevelling Tool	25mm
GMUP213	Barrier Pipe Bevelling Tool	32mm
GMUP214	Barrier Pipe Bevelling Tool	40mm

- To ensure a uniformly round bevel for easy connections
- Use with the handle provided or with a drill for speed

3 in 1 Barrier Pipe Bevelling Tools



STÖRNCH

- To ensure a uniformly round bevel for easy connections

Part No	Description	Size
GMUP216	3 in 1 Barrier Pipe Bevelling Tool	16/20/25mm
GMUP217	3 in 1 Barrier Pipe Bevelling Tool	20/25/32mm



Barrier Pipe Outside Bending Spring



- For bending 25mm Ø Barrier pipe externally
- Ensures an even bend without kinks

Part No	Description	Pipe Size
GMUP212	Outside Bending Spring	25mm Ø

Barrier Pipe Inside Bending Spring



- For bending 25mm Ø Barrier pipe internally
- Ensures the bore diameter is maintained when bending

Part No	Description	Pipe Size
GMUP211	Inside Bending Spring	25mm Ø

Rothenberger Barrier Pipe Bending Tool

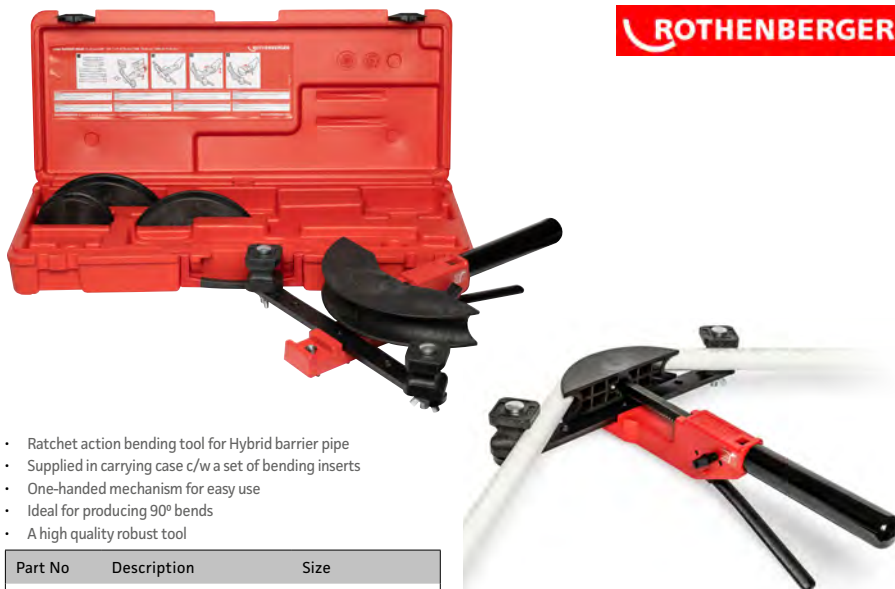

- Ratchet action bending tool for Hybrid barrier pipe
- Supplied in carrying case c/w a set of bending inserts
- One-handed mechanism for easy use
- Ideal for producing 90° bends
- A high quality robust tool

Part No	Description	Size
GMUP215	Barrier Pipe Bending Tool	16/20/25 & 32mm

Push Fit Straight Coupler



- For connecting 25mm Ø Barrier pipe together

Part No	Description	Size	Qty/Pk
GMPPF1	Push Fit Straight Couplers	25mm Ø	Pk5

Push Fit 90° Bend



- For connecting 25mm Ø Barrier pipe together

Part No	Description	Size	Qty/Pk
GMPPF11	Push Fit 90° Bends	25mm Ø	Pk5

Push Fit Tees



- For connecting 25mm Ø Barrier pipe together

- **GMPPF30** Female Iron Barrier Push-Fit Tee with 1/2" female threaded branch for connecting 25mm barrier pipe to hybrid products with 1/2" male threads.
- These tees are used in conjunction with automatic air vents, drain off cocks, and using a brass threaded bush, pressure gauges or manual air vents.

Part No	Description	Size	Qty/Pk
GMPPF30	Threaded Push Fit Tee	25mm x 25mm x 1/2"	Pk 4
GMPPF31	Push Fit Equal Tee	25mm Ø	Pk5

Push Fit Copper Adapter



- Often used as a way to come off the HBC stubs
- For converting 22mm Ø copper pipe to 25mm Ø Barrier pipe

Part No	Description	Size	Qty/Pk
GMPPF70	Push Fit Copper Adapters	25mm Ø x 22mm	Pk5

Push Fit Female Thread Adapter



- For connecting 25mm Ø Barrier pipe to fittings with a 3/4" male thread

Part No	Description	Size	Qty/Pk
GMPPF66	Push Fit Female Thread Adapters	25mm Ø x 3/4"	Pk5

Push Fit Male Thread Adapter



- For connecting 25mm Ø Barrier pipe to the Hybrid fan coil units

Part No	Description	Size	Qty/Pk
GMPPF65	Push Fit Male Thread Adapters	25mm Ø x 3/4"	Pk5

Plumbing Copper Tube - 3mt



- Half hard copper tube which conforms to BS EN 1057 R250 Table X

Part No	Description	Size	Length
GMPC2	Copper Tube	22mm x 0.9mm	3mt

Insulation Coil - Class '0'



- Armaflex class 0 insulation with built in anti-microbial and vapour barrier protection

Part No	Description	Pipe Size	Wall Size	Length
GMEU55	Insulation	22mm	9mm (3/8")	15mt
GMEU63	Insulation	22mm	13mm (1/2")	15mt

Insulation - Class '0'



- Armaflex class 0 insulation with built in anti-microbial and vapour barrier protection

Part No	Description	Pipe Size	Wall Size	Length
GMEU41	Insulation	22mm	9mm (3/8")	2mt
GMEU23	Insulation	22mm	13mm (1/2")	2mt

Copper Press Fit Straight Coupler



- For connecting 22mm copper pipe together

Part No	Description	Size	Qty/Pk
GMCP2	Press Fit Straight Couplers	22mm	pk10

Copper Press Fit 90° Bend



- For connecting 22mm copper pipe together

Part No	Description	Size	Qty/Pk
GMCP12	Press Fit 90° Bends	22mm	pk10

Copper Press Fit 45° Bend



- For connecting 22mm copper pipe together

Part No	Description	Size	Qty/Pk
GMCP22	Press Fit 45° Bends	22mm	pk10

Copper Press Fit Equal Tee



- For connecting 22mm copper pipe together

Part No	Description	Size	Qty/Pk
GMCP32	Press Fit Equal Tees	22mm	pk10

Copper Press Fit Reducing Tee



- Also used in conjunction with GMPC61 Long Stem Drain Off Cock

Part No	Description	Size	Qty/Pk
GMCP33	Press Fit Reducing Tees	22 x 22 x 15mm	pk10

Copper Press Fit Tee



- These tees are crimped on to 22mm plumbing copper
- The 1/2" female thread will accept AAV's, Drain Off Cocks, Pressure Gauges and Manual Air Vents (may need a GMPC253 Hex Bush)

Part No	Description	Size	Qty/Pk
GMCP62	Press Fit Tee	22 x 22 x 1/2" FT	pk10

Copper Press Fit Male Adapter



- For connecting 22mm copper pipe to the Hybrid fan coil unit

Part No	Description	Size	Qty/Pk
GMCP51	Press Fit Male Thread Adapter	22mm x 1/4"	pk10

Copper Press Fit Ball Valve



- Used for isolating the Hybrid pipework
- Supplied with a lever and 22mm copper press fit ends

Part No	Description	Size
GMCP42	Copper Press Fit Ball Valve	22mm

Copper Press DZR Brass Y Strainer



- Installed as part of the filling loop on a Hybrid system
- Provides filtration to prevent debris from getting into the system

Part No	Description	Size
GMCP71	Press Fit Y Strainer	22 mm

Threaded Drain Off Cock



- Install at least one drain off cock per fan coil unit
- Screws into a female iron tee (GMPC58)

Part No	Description	Size
GMPC62	Threaded Drain Off Cock	½"

Long Stem Drain Off Cock



- Usually crimped onto a GMCP33 22 x 22 x 15mm Reducing Tee

Part No	Description	Size
GMPC61	Long Stem Drain Off Cock	15mm

Air Admittance Valve



- For releasing air from the Hybrid system
- Install at least one AAV per fan coil unit at the highest points of the pipework

Part No	Description	Size
GMHYAV15	Air Admittance Valve	½"

Manual Air Vent & Hex Bush



- This is an air vent designed to manually remove any air trapped inside the wet side of the Hybrid system

Part No	Description	Size
GMPC275	Manual Air Vent	¼" BSP
GMPC253	Brass Hexagon Bush	½" M x ¼" F

Brass Y Strainer



- c/w 22mm compression ends
- Installed as part of the filling loop on the Hybrid system, and will provide filtration to help prevent debris from getting into the system

Part No	Description	Size
GMPC588	Brass Y Strainer	22mm

Brass Double Check Valve



- c/w 22mm compression ends
- This is a twin non-return valve which is installed as part of the filling loop on the Hybrid system, and will prevent backflow to the water supply

Part No	Description	Size
GMPC305	Brass Double Check Valve	22mm

¼ Turn Lever Ball Valve



- Nickel Plated
- WRAS Approved
- c/w red & blue handles

Part No	Description	Size
GMPC302	Lever Ball Valve	22mm

PTFE Thread Seal tape



- Ensures a safe, leak-free joint
- Wind onto the fitting in the direction of the thread
- For use with water systems only
- WRAS approved
- Conforms to BS7786:1995

Part No	Description	Size
GMT7	PTFE Tape (0.075mm thick)	12mt

Loctite 55 Sealing Cord



- Designed for the locking and sealing of metal and plastic pipes and fittings
- It needs no cure time and results in an immediate full pressure seal

Part No	Description	Size
GMT9	Loctite 55 Thread Sealing Cord	160mt

Expansion Tanks



- Expansion Tanks comply with EN13831 approved to PED 2014/68/EU
- Threaded connections
- Non-replaceable diaphragm, according to EN 13831 norm part 3, maximum operating temperature of 70 Degrees Celsius
- Durable epoxy coating
- Factory pre-pressurised gas chamber (Nitrogen)
- Requires a GMHYET1 Universal Mounting Bracket
- Requires a GMHYFLKIT Evolve EV-EVK Vessel Hose Kit 1

Part No	Description	Size
GMET8	Expansion Tank	8 Litre
GMET12	Expansion Tank	12 Litre
GMET18	Expansion Tank	18 Litre
GMET25	Expansion Tank	25 Litre

Universal Mounting Bracket



- For wall mounting Expansion Tanks from 8 litre to 25 litre

Part No	Description
GMHYET1	Universal Mounting Bracket for Expansion Tank

Expansion Tanks

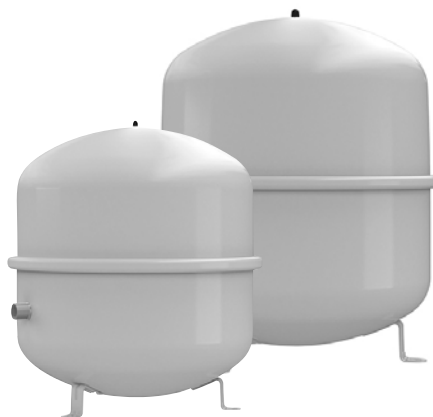

- Expansion Tanks comply with EN13831 approved to PED 2014/68/EU
- Threaded connections
- Non-replaceable diaphragm, according to EN 13831 norm part 3, maximum operating temperature of 70 Degrees Celsius
- Durable epoxy coating
- Factory pre-pressurised gas chamber (Nitrogen)
- Requires a GMHYFLKIT Evolve EV-EVK Vessel Hose Kit 1
- These three sizes come with feet therefore do not require a Universal Mounting Bracket

Part No	Description	Size
GMET35	Expansion Tank	35 Litre
GMET50	Expansion Tank	50 Litre
GMET80	Expansion Tank	80 Litre

Vessel Hose Kit



- Includes filling loop, pressure reducing valve and gauge
- Is used when fitting an expansion tank to pressurise the Hybrid circuit

Part No	Description
GMHYFLKIT	Vessel Hose Kit

Pressure Reducing Valve with Gauge



- Used for setting and maintaining the Hybrid system pressure
- c/w 22mm compression fittings with 15mm reducing inserts
- Suitable for horizontal and vertical mounting

Part No	Description	Size
GMPC590	Pressure Reducing Valve	22/15mm

0-10 Bar Pressure Gauge & Hex Bush



- Used to display the Hybrid system pressure
- Use the hexagon bush to connect pressure gauge to female iron tee

Part No	Description	Size
GMPC592	0-10 Bar Pressure Gauge	50mm/3/4"
GMPC253	Brass Hexagon Bush	1/2" M x 3/4" F



HYBRIDHUB

PRESSFIT & HYBRID VRF INSTALL MATERIALS

The leading resource for Pressfit & Hybrid training: www.pressfitsolutions.com

Following the correct installation process is essential for all pressfit and hybrid systems. Which is why we provide detailed training videos on our pressfitsolutions.com website.

Covering all the leading pressfit systems, our easy-to-follow videos will take you through the installation process step-by-step.

And once you've watched a training video, you can register for your personal Training Certificate.

To make sure you and your team are installing pressfit and hybrid correctly, watch our training videos at:

pressfitsolutions.com



For the complete range of Hybrid install materials, check out our Version 15 In-Stock Catalogue

IN STOCK
VERSION

15

- Rubber Feet
- Basket Tray
- Channel
- Cable
- Studding
- Fixings
- Brackets & More...



HYBRID 20mm BARRIER PRESS - PIPE INSTALLATION GUIDE

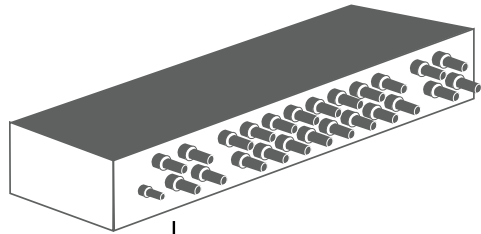

Hybrid Branch Controller
(22mm Stubs)

1 HBC CONNECTORS

GMCP2 & GMUP79 22mm Copper Pressfit Straight Coupler
20x22mm Barrier Pressfit to Copper Press Adapter

2 BARRIER PIPE

GMUP108 Pre-Insulated Barrier Pipe
20mm x 50m with 13mm Insulation

3 BALL VALVES

GMUP40 20mm Barrier Pressfit Lever Ball Valve

4 BARRIER PIPE

GMUP108 Pre-Insulated Barrier Pipe
20mm x 50m with 13mm Insulation

5 AAVs & DOCs

GMPC62 & GMUP63 Threaded Drain Off Cock
1/2" 20mm x 20mm x 1/2" FT Barrier Pressfit Tee

GMHYAV15 & GMUP63 15mm AAV (Air Admittance Valve)
20mm x 20mm x 1/2" FT Barrier Pressfit Tee

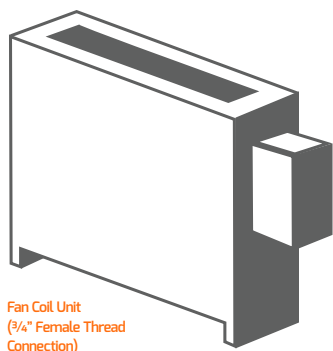

Fan Coil Unit
(3/4" Female Thread Connection)

9 FAN COIL UNIT CONNECTIONS

GMUP50 20mm - 3/4" Barrier Pressfit Male Thread Adapter

8 BARRIER PIPE

GMUP108 Pre-Insulated Barrier Pipe
20mm x 50m with 13mm Insulation

7 BALL VALVES

GMUP40 20mm Barrier Pressfit Lever Ball Valve

6 BARRIER PIPE

GMUP108 Pre-Insulated Barrier Pipe
20mm x 50m with 13mm Insulation

OPTIONAL EXTRAS

GMUP4 Couplers
GMUP10 90° Bends

HYBRID 25mm BARRIER PRESS - PIPE INSTALLATION GUIDE

HYBRIDHUB
PRESSFIT & HYBRID VRF INSTALL MATERIALS

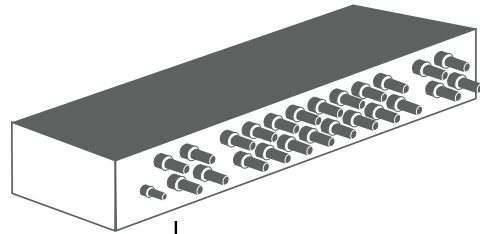

Hybrid Branch Controller
(22mm Stubs)

1 HBC CONNECTORS

GMCP2 & GMUP80
22mm Copper Pressfit Straight Coupler
25x22mm Barrier Pressfit to Copper Press Adapter

2 BARRIER PIPE

GMUP120
Pre-Insulated Barrier Pipe
25mm x 50m with 13mm Insulation

3 BALL VALVES

GMUP41
25mm Barrier Pressfit Lever Ball Valve

4 BARRIER PIPE

GMUP120
Pre-Insulated Barrier Pipe
25mm x 50m with 13mm Insulation

5 AAVs & DOCs

GMPC62 & GMUP65
Threaded Drain Off Cock
1/2"
25mm x 25mm x 1/2" FT
Barrier Pressfit Tee

GMHYAV15 & GMUP65
15mm AAV (Air Admittance Valve)
25mm x 25mm x 1/2" FT
Barrier Pressfit Tee

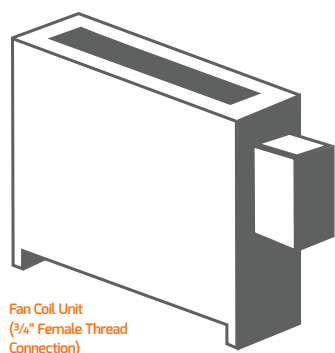

Fan Coil Unit
(3/4" Female Thread Connection)

9 FAN COIL UNIT CONNECTIONS

GMUP51
25mm - 3/4" Barrier Pressfit Male Thread Adapter

8 BARRIER PIPE

GMUP120
Pre-Insulated Barrier Pipe
25mm x 50m with 13mm Insulation

7 BALL VALVES

GMUP41
25mm Barrier Pressfit Lever Ball Valve

6 BARRIER PIPE

GMUP120
Pre-Insulated Barrier Pipe
25mm x 50m with 13mm Insulation

OPTIONAL EXTRAS

GMUP1 Couplers
GMUP11 90° Bends
GMUP31 Equal Tees



IMPORTANT NOTE: These schematic drawings are only intended as a general guide and do not replace the need to obtain specific external project advice from unit manufacturers & professional bodies like WRAS & BSRIA. It is the installation companies and system designer's responsibility to seek guidance.

HYBRID 32mm BARRIER PRESS - PIPE INSTALLATION GUIDE

HYBRIDHUB
PRESSFIT & HYBRID VRF INSTALL MATERIALS

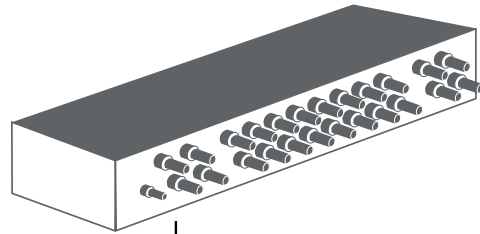

Hybrid Branch Controller
(22mm Stubs)

1 HBC CONNECTORS

GMCP2 & GMUP81
22mm Copper Pressfit Straight Coupler
32x22mm Barrier Pressfit to Copper Press Adapter

2 BARRIER PIPE

GMUP140
Pre-Insulated Barrier Pipe
32mm x 50m with 13mm Insulation

3 BALL VALVES

GMUP42
32mm Barrier Pressfit Lever Ball Valve

4 BARRIER PIPE

GMUP140
Pre-Insulated Barrier Pipe
32mm x 50m with 13mm Insulation

5 AAVs & DOCs

GMPC62 & GMUP66
Threaded Drain Off Cock
1/2"
32mm x 32mm x 1/2" FT
Barrier Pressfit Tee

GMHYAV15 & GMUP66
15mm AAV (Air Admittance Valve)
32mm x 32mm x 1/2" FT
Barrier Pressfit Tee

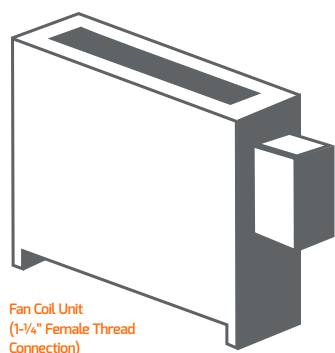

Fan Coil Unit
(1-1/4" Female Thread Connection)

9 FAN COIL UNIT CONNECTIONS

GMUP52
32mm - 1-1/4" Barrier Pressfit Male Thread Adapter

8 BARRIER PIPE

GMUP140
Pre-Insulated Barrier Pipe
32mm x 50m with 13mm Insulation

7 BALL VALVES

GMUP42
32mm Barrier Pressfit Lever Ball Valve

6 BARRIER PIPE

GMUP140
Pre-Insulated Barrier Pipe
32mm x 50m with 13mm Insulation

OPTIONAL EXTRAS

GMUP2 Couplers
GMUP12 90° Bends



IMPORTANT NOTE: These schematic drawings are only intended as a general guide and do not replace the need to obtain specific external project advice from unit manufacturers & professional bodies like WRAS & BSRIA. It is the installation companies and system designer's responsibility to seek guidance.

HYBRID 40mm BARRIER PRESS - PIPE INSTALLATION GUIDE

HYBRIDHUB
PRESSFIT & HYBRID VRF INSTALL MATERIALS

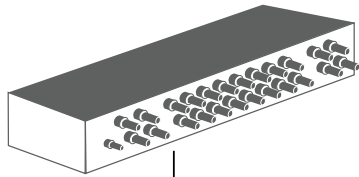

Hybrid Branch Controller
(22mm Stubs)

1 HBC CONNECTORS



GMCP2 & GMUP80
22mm Copper Pressfit Straight Coupler
25x22mm Barrier Pressfit to Copper Press Adapter

2 BARRIER PIPE



GMUP102 Barrier Pipe 25mm x 3.9m

3 BARRIER PRESSFIT REDUCER



GMUP4025 Barrier Pressfit Reducer 40mm - 25mm

4 BARRIER PIPE



GMUP104 Barrier Pipe 40mm x 3.9m

5 BALL VALVE

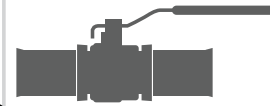

GMUP43 40mm Barrier Pressfit Lever Ball Valve

6 BARRIER PIPE



GMUP104 Barrier Pipe 40mm x 3.9m

INSULATION OPTIONS



Armaflex Class 'O' Insulation
GMEU26 13mm Wall 2m
GMEU77 19mm Wall 2m

OPTIONAL EXTRAS

GMUP3 Couplers
GMUP13 90° Bends

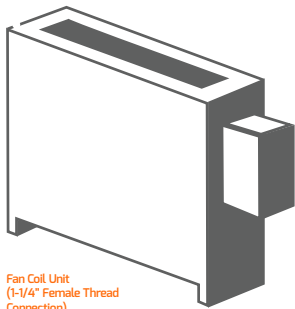

Fan Coil Unit
(1-1/4" Female Thread Connection)

11 FAN COIL UNIT CONNECTIONS

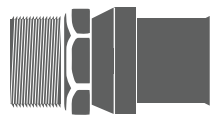

GMUP54 40mm - 1-1/4" Pressfit Male Thread Adapter

10 BARRIER PIPE



GMUP104 Barrier Pipe 40mm x 3.9m

9 BALL VALVE

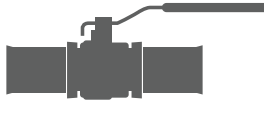

GMUP43 40mm Barrier Pressfit Lever Ball Valve

8 BARRIER PIPE



GMUP104 Barrier Pipe 40mm x 3.9m

7 AAVs & DOCs

GMPC62 & GMPC254 & GMUP67

Threaded Drain Off Cock 1/2"
Brass Hexagon Bush 3/4" M x 1/2" F
40mm x 40mm x 3/4" FT Barrier Pressfit Tee

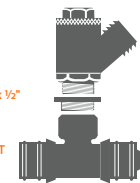

GMHYAV15 & GMPC254 & GMUP67

15mm AAV (Air Admittance Valve)
Brass Hexagon Bush 3/4" M x 1/2" F
40mm x 40mm x 3/4" FT Barrier Pressfit Tee

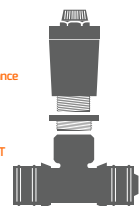

IN STOCK ON SITE ON TIME

IMPORTANT NOTE: These schematic drawings are only intended as a general guide and do not replace the need to obtain specific external project advice from unit manufacturers & professional bodies like WRAS & BSRIA. It is the installation companies and system designer's responsibility to seek guidance.

HYBRID 25mm PUSH FIT INSTALLATION GUIDE

HYBRIDHUB

PRESSFIT & HYBRID VRF INSTALL MATERIALS

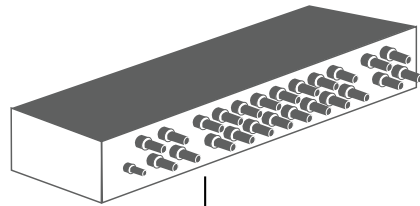

Hybrid Branch Controller
(22mm Stubs)

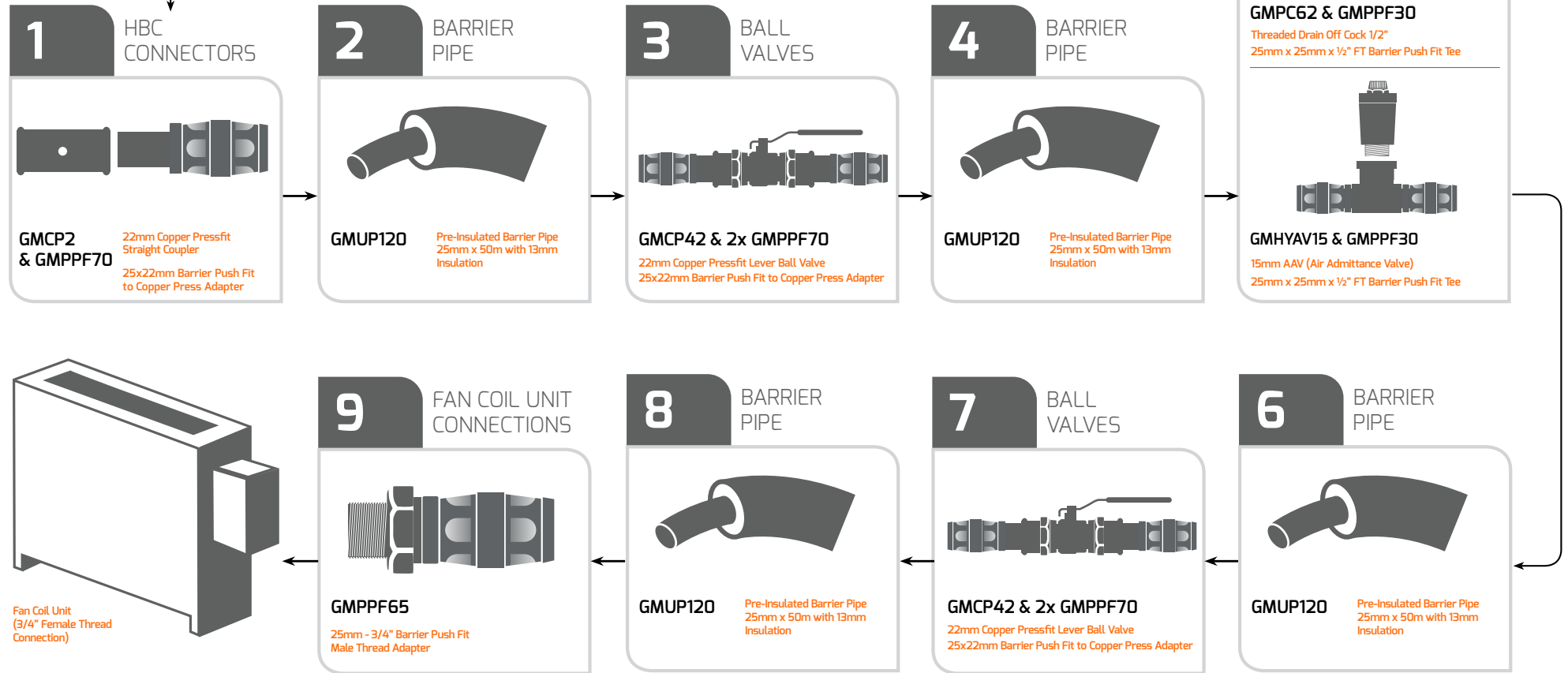

OPTIONAL EXTRAS

- GMPPF1 Push Fit Straight Couplers
- GMPPF11 Push Fit 90° Bends
- GMPPF31 Push Fit Equal Tees



IMPORTANT NOTE: These schematic drawings are only intended as a general guide and do not replace the need to obtain specific external project advice from unit manufacturers & professional bodies like WRAS & BSRIA. It is the installation companies and system designer's responsibility to seek guidance.

HYBRID COPPER PRESSFIT INSTALLATION GUIDE

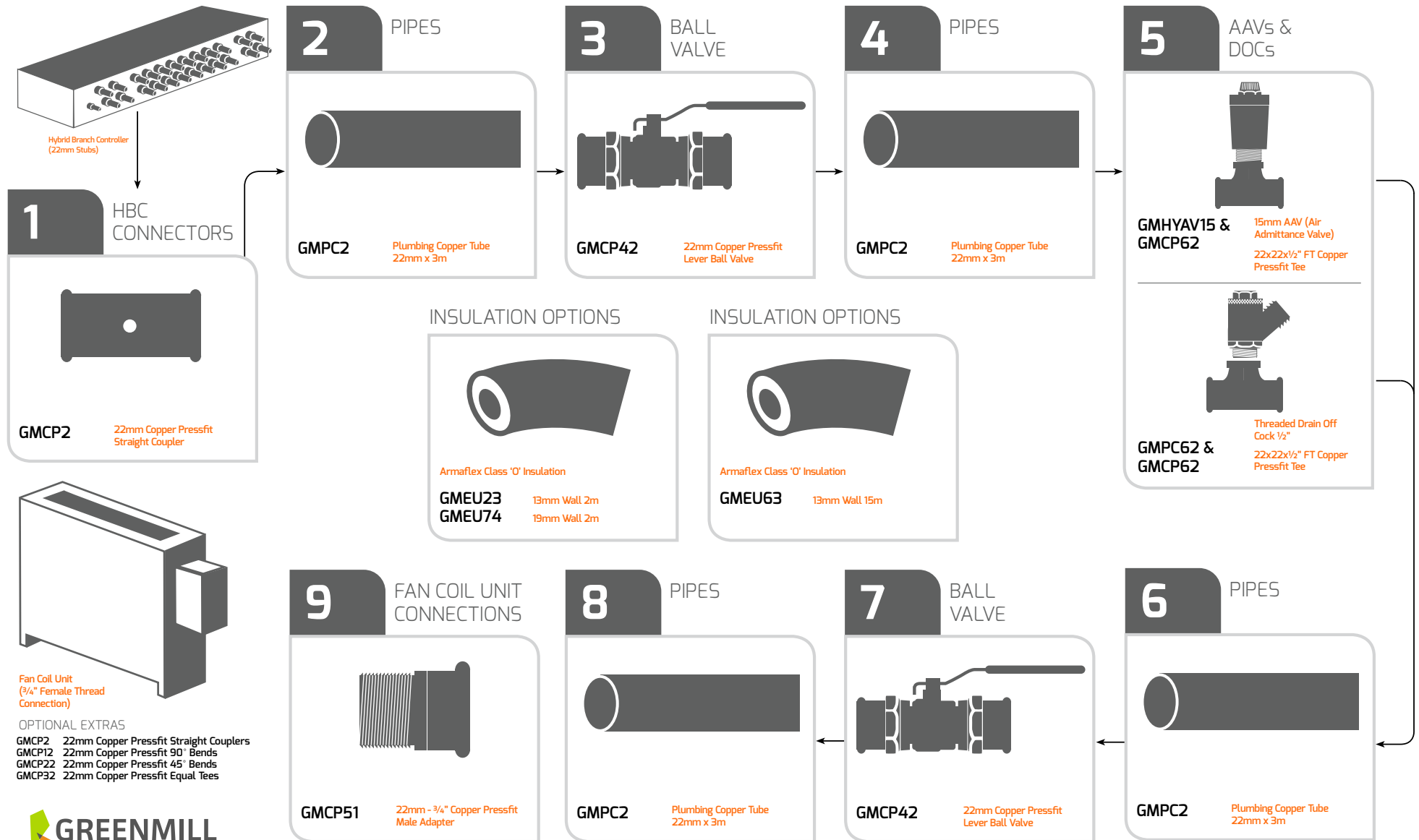

HYBRID WATER SUPPLY INSTALLATION GUIDE

HYBRIDHUB

PRESSFIT & HYBRID VRF INSTALL MATERIALS

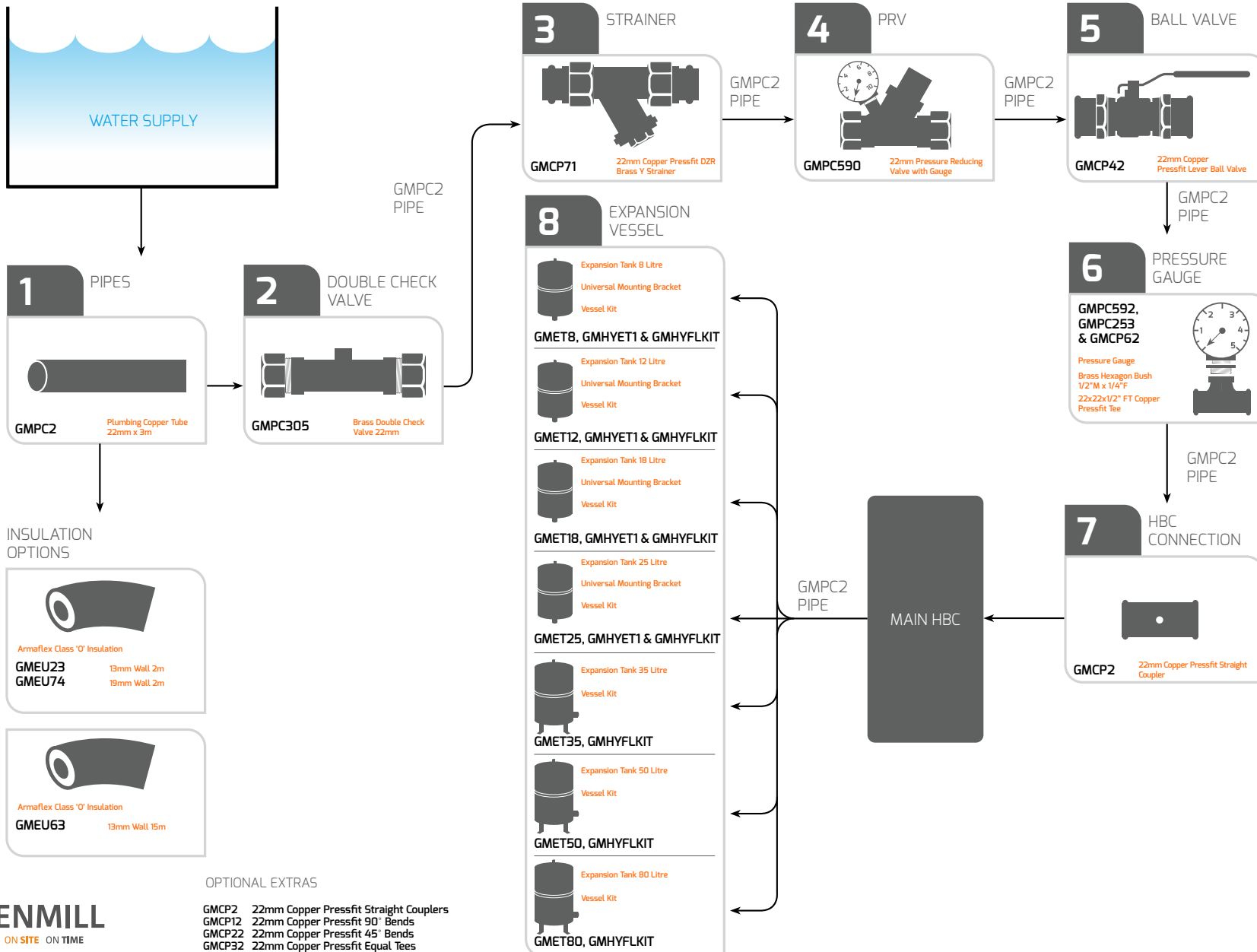

IMPORTANT NOTE: These schematic drawings are only intended as a general guide and do not replace the need to obtain specific external project advice from unit manufacturers & professional bodies like WRAS & BSRIA. It is the installation companies and system designer's responsibility to seek guidance.

HYBRIDHUB

PRESSFIT & HYBRID VRF INSTALL MATERIALS



GREENMILL
IN STOCK ON SITE ON TIME



www.greenmillac.com
sales@greenmillac.com

01206 864 467