



GREENMILL

IN STOCK ON SITE ON TIME

IN STOCK
VERSION

15



**AIR CONDITIONING & VENTILATION
INSTALL MATERIALS**

Ordering install materials has never been easier with **Version 15** of your favourite in stock catalogue

Welcome to our latest Version 15 in stock catalogue. Throughout 2022 we've been heavily focussed on developing two important areas of our business, Stock and Service.

Greenmill maintains one of the UK's largest stock holdings of AC, Vent and Heat Pump install materials. However, we are always looking to improve, and our plans for the coming year will ensure we continue to deliver on our promise of In Stock, On Site, On Time.

Customer Service is central to everything we do at Greenmill. In fact, it's so important we've even made up a word for it "Focustomer". And this year we've worked especially hard, training and developing our people, so that the Focustomer is front and centre across the whole Greenmill team.

The bumper V15 catalogue includes our ever-expanding in stock range, with the majority of products available with free next day delivery. Ordering your install materials has never been easier, give our team a call on

01206 864 467 or order online at:
www.greenmillac.com



NICO MILLER
Founder



TRISTAN MILLER
Director

20 Over
YEARS
OF EXCELLENCE



In this catalogue:

SECTION	PAGES
Introduction to Greenmill	04 – 06
Condenser Support	07 – 20
Air Conditioning Fixings	21 – 55
Pipe Clips & Clamps	56 – 67
Copper & Lagging, Brazing & Gas	68 – 87
Air Conditioning Trunking	88 – 102
Pressfit Solutions	103 – 114
Hybrid VRF Install Materials	115 – 127
Condensate Removal	128 – 160
Air Conditioning Electrical	161 – 174
Service, Maintenance, Tools & Site Supplies	175 – 241
SpiraSafe & Fittings	242 – 250
Standard Spiral & Fittings	251 – 261
Grilles, Diffusers & Plenums	262 – 275
Heat Recovery & Plastic Ducting	276 – 287
Heat Pump Install Materials	288 – 292

Why Greenmill?

Delivering a **First Class** experience

Ask our customers why we are the engineer's choice for AC, Vent and Heat Pump install materials, and you'll get loads of different answers.

For some it will be our deep and competitive product range, for others it's nationwide next day delivery. Lots of customers enjoy our quick and easy website ordering and access to the MyGreenmill online dashboard. Plus, we've got our regular free-gift promos and, new this year, our great Customer Rewards scheme.

There's one thing that all of these answers have in common, they're all part of the Greenmill customer experience. From your initial contact with Greenmill, through to delivery, after-sales support, product training and ongoing account management, our team is focussed on delivering a first class customer experience, first time and every time. So, get on board with Greenmill.



Our culture & values

Putting **YOU** at the heart of everything we do.

Every Greenmill employee strives to deliver a consistent and flawless experience that aligns with the values we all share.

Established in 2001, Greenmill has achieved over 20 years of continuous growth by building a customer experience culture that puts you at the heart of everything we do.

Each Greenmill employee strives to deliver a consistent and flawless experience that aligns with the values we all share. We've already mentioned

Focustomer, which is central to everything we do. However, we wouldn't be able to deliver on this commitment without our team of efficient and fiercely passionate people, who take responsibility for what they do, and how well they do it.



FOCUSTOMER

PASSIONATE

RESPONSIBLE

TEAMWORK

TIME-SMART

Rewarding our customers



Whether it's the free sweet treats in each delivery, or our Customer Reward scheme, we think it's important to say, "thank you".

Launched at the start of 2022, the Greenmill Customer Reward scheme continues to go down a storm. But if you're not sure what great gifts you want to spend your reward points on, or even how many points you've got, head over to our brand new MyRewards website. As soon as you arrive at the site, you can see exactly how many reward points you've got to spend. And when you're ready to redeem your points, simply click through to the online range, select your chosen rewards, add them to your basket and check out. Free stuff, delivered where you want it, job done!

Remember, we continually add new tools and gifts to the Customer Reward range, so make sure you visit the MyRewards site regularly or download the latest Rewards catalogue.

What will you choose?



STÖRNCH Condenser Support

Contents

Roof Support Frames	08
H-Frame Supports	09
STÖRNCH Mini Feet	10
Rubber Support Feet	11
Condenser Wall Brackets	12
R-T-G Bracket Sets & Cantilever Arms	13
Condensing Unit Guards	14 - 17
Condensing Unit Trays	18
Vibration Control	19 - 20



Big Foot Base Frame & Extender Frame



- 1.0m x 1.2m multiples
- Hot-dipped galvanised steel framework
- Quick and easy to assemble
- Adjustable leg assemblies
- Integrated rubber mats
- The Base Frame has the ability to extend from any side using the Extension Kit giving you the flexibility to create the frame configuration to suit your install

Part No	Description	Size
GMCG25	Big Foot Base Frame	1mt x 1.2mt
GMCG26	Big Foot Extender Frame	1mt x 1.2mt



Strut Foot Base Frame & Extender Frame



- A fast and economical system for mounting M&E services, Air conditioning & Refrigeration on flat roofs
- No penetration of waterproof roof membrane
- Anti-Vibration pads pre-attached to feet
- Cross compatibility with all Unistrut type brackets

Part No	Description	Size
GMCG28	Strut Foot Base Frame	1mt x 1.3mt
GMCG29	Strut Foot Extender Frame	1mt x 1.3mt

StrutDirectLtd

Big Foot H-Frame Set

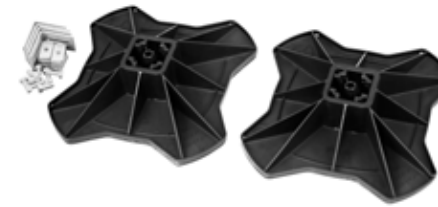

- Quick and economical solution for supporting pipework, tray or ductwork
- Pack includes 2 feet, Unistrut brackets and fixings

Part No	Description	Size	Recommended Frame Load
GMCG7	H-Frame Set	305mm ²	300kg



Note: Channel not included

Big Foot H-Frame Set



- Quick and economical solution for supporting pipework, tray or ductwork
- Pack includes 2 feet, Unistrut brackets and fixings

Part No	Description	Size	Recommended Frame Load
GMCG9	H-Frame Set	450mm ²	500kg



Note: Channel not included

H-Frame Set

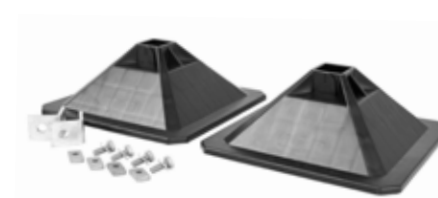

- Feet are supplied with fixings & brackets
- No penetration of waterproof roof membrane
- Anti-Vibration pads pre-attached to feet

Part No	Description	Size	Recommended Frame Load
GMCG27	H-Frame Set	305mm ²	300kg



Note: Channel not included

Minifoot 110mm

STÖRNCH
Condenser Support



- Lightweight support suited for pipework, cable tray, & basket etc
- Accommodates 41 x 41mm channel horizontally or vertically
- Recommended load – 25kg per foot

Part No	Description	Size
GMPMF110	Minifoot	110mm x 110mm

Minifoot 160mm

STÖRNCH
Condenser Support



- Recommended load – 50kg per foot

Part No	Description	Size
GMPMF160	Minifoot	160mm x 160mm

Minifoot 110mm (M8 Thread)

STÖRNCH
Condenser Support



- Recommended load – 25kg per foot
- Works in conjunction with M8 threaded rod or fasteners

Part No	Description	Size
GMPMF8110	Minifoot M8 Stud	110mm x 110mm

Minifoot 160mm (M8 Thread)

STÖRNCH
Condenser Support



- Recommended load – 50kg per foot
- Works in conjunction with M8 threaded rod or fasteners

Part No	Description	Size
GMPMF8160	Minifoot M8 Stud	160mm x 160mm

Minifoot 110mm c/w 250mm Channel

STÖRNCH
Condenser Support



- Recommended load - 50kg per kit

Part No	Description	Size
GMPMF250	Minifoot Kit with 250mm Channel	110mm

Adjustable Duct Support

StrutDirectLtd

- Non-penetrative duct support
- Quick and easy to install
- M8 Stud
- 305mm foot c/w Anti-vibration pad
- Height adjustable between 220 - 400mm
- Total height 600mm from floor
- Static max. Load 80kg
- Adjustable Tube with thumb screw and foot adapter



Part No	Description	Qty/Pk
GMCG50	Adjustable Duct Supports (M8 Stud)	pk 5

Rubber Support Feet 250mm

STÖRNCH
Condenser Support



- Neat and tidy, non-penetrative rooftop support solution
- 40mm x 20mm aluminium channel recessed into the top face, to allow for easy fixing of services
- Suitable for pipework, ductwork and cable tray runs
- Made from durable, recycled rubber, offering built in anti-vibration properties, and making these an economical and environmentally responsible solution

Part No	Description	Size	Max Load/foot
GMCG20	Small Foot	250 x 180 x 95mm	80kg

Rubber Support Feet 400mm

STÖRNCH
Condenser Support



Part No	Description	Size	Max Load/foot
GMCG21	Medium Foot	400 x 180 x 95mm	125kg

Rubber Support Feet 600mm

STÖRNCH
Condenser Support



Part No	Description	Size	Max Load/foot
GMCG22	Large Foot	600 x 180 x 95mm	220kg

Rubber Support Feet 1000mm

STÖRNCH
Condenser Support



Part No	Description	Size	Max Load/foot
GMCG23	X-Large Foot	1000 x 180 x 95mm	290kg

Condensing Unit Blocks



Part No	Description	Size	Qty/Pk
GM2CBB	Condensing Unit Blocks	450mm	Pair
GM3CBB	Condensing Unit Blocks	1000mm	Pair
GM4CBB	Black End Cap		Each

- Safe workload to approx 200kg
- Can be cut to length if required
- Reduces condenser vibration
- Supplied with necessary bolts for a simple and rapid installation

Condenser Wall Bracket Set - 60 & 90kg



- Adjustable universal pre-assembled wall brackets with hook system
- Easy installation and adjustment of the mounting distance.
- Level and back plate spacer included for a correct positioning.

Height	400mm
Crossbar width	800mm
Depth	465mm

Height	400mm
Crossbar width	800mm
Depth	550mm

Part No	Description	Weight
GMCB4	Condenser Wall Bracket Set	60kg

Part No	Description	Weight
GMCB5	Condenser Wall Bracket Set	90kg

Condenser Wall Bracket Set - 140kg



STÖRNCH
Condenser Support

- Galvanised steel & powder coated - conforms to ISO 09227 corrosion test
- Heavy gauge for added strength
- Integrated spirit level for easy installation
- High quality fixings supplied for secure installation
- Interlocking design, part assembled for fast installation
- Anti vibration pads as standard
- Bracket can be mounted using horizontal wall bar, or directly to the wall as bracket arm pairs
- Easy levelling on uneven walls, with adjustable bolt
- Suitable for use with drip trays

Height	450mm
Crossbar width	850mm
Depth	550mm
Gauge	2.0mm

Part No	Description	Weight
GMCB6	Condenser Wall Bracket Set	140kg



STÖRNCH Ready-To-Go Bracket Sets

STÖRNCH
Condenser Support



- The STÖRNCH "Ready-to-go" set is a cantilever set flat packed with all the necessary fixings for an installation.
- Save time on site - time is money!

SET CONTAINS:

- 1 pair of Cantilever Arms
- End Caps
- Channel Nuts
- 2 Lengths of 41 x 41mm x 750mm H.D. Channel
- Rawlbolts
- Bolts and Washers



Part No	Description	Size	Weight
GMCN20	Ready-To-Go Bracket Set	450mm	160kg
GMCN21	Ready-To-Go Bracket Set	600mm	160kg
GMCN5	Ready-To-Go Bracket Set	750mm	160kg

Cantilever Bracket Arms



Part No	Description	Size
GMCN32	Cantilever Arm	300mm
GMCN18	Cantilever Arm	450mm
GMCN19	Cantilever Arm	600mm
GMCN31	Cantilever Arm	750mm
GMCN33	Cantilever Arm	900mm
GMCN36	Cantilever Arm	1000mm

- Hot-dip galvanised
- Used for pipework support and mounting air conditioning units to walls
- Can be used with channel using channel nuts

Part No	Description	Size
GMCN18D	Back-to-Back Cantilever Arm	450mm
GMCN19D	Back-to-Back Cantilever Arm	600mm

Black Unit Guards



- Unique sliding panel system
- All panels can be removed for maintenance by unscrewing just four bolts
- Additional bottom and back panels are available for stand alone/high wall options
- All bolts are allen-headed for added security
- Quick and easy to install and access for maintenance
- Finished in black powder coat

Part No	Description	Size	External H (mm)	External W (mm)	External D (mm)
GMCGSBL	Condensing Unit Guard	Small	750	1050	460
GMCGMBL	Condensing Unit Guard	Medium	1150	1150	650
GMCGLBL	Condensing Unit Guard	Large	1450	1150	650
GMCGXLBL	Condensing Unit Guard	Extra Large	1800	1150	650

Top/Bottom Panels

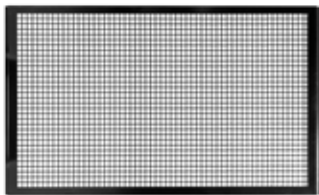

- Can be used as top or bottom panels
- **GMCGSBBL** - Replacement panel for small condensing unit guards
- **GMCGMLBBL** - Replacement panel for medium, large or extra-large condensing unit guards (This panel is exactly the same for each size, so is compatible with all guards except the small size)

Part No	Description	Size
GMCGSBBL	Top or Bottom Panel	Small
GMCGMLBBL	Top or Bottom Panel	Med, Large & X-Large

Back Panels

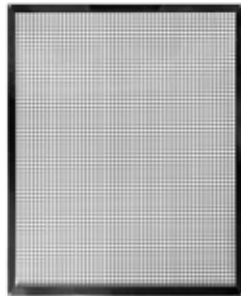

- Finished in black powder coat

Part No	Description	Size
GMCGSPBL	Back Panel	Small
GMCGMPBL	Back Panel	Medium
GMCGLPBL	Back Panel	Large

Condensing Unit Guards



- Unique sliding panel system
- All panels can be removed for maintenance by unscrewing just four bolts
- Additional bottom and back panels are available for stand alone/high wall options
- All bolts are allen-headed for added security
- Quick and easy to install and access for maintenance
- Textured finish in RAL7032 Pebble Grey

Part No	Description	Size	External H (mm)	External W (mm)	External D (mm)
GMCG41	Condensing Unit Guard	Small	750	1050	460
GMCG16	Condensing Unit Guard	Intermediate	950	1050	650
GMCG42	Condensing Unit Guard	Medium	1150	1150	650
GMCG43	Condensing Unit Guard	Large	1450	1150	650
GMCG48	Condensing Unit Guard	Extra Large	1800	1150	650

Top/Bottom Panels



- Can be used as top or bottom panels
- **GMCG41T** - Replacement panel for small condensing unit guards
- **GMCG42T** - Replacement panel for medium, large or extra-large condensing unit guards (This panel is exactly the same for each size, so is compatible with all guards except the small size)

Part No	Description	Size
GMCG41T	Top or Bottom Panel	Small
GMCG42T	Top or Bottom Panel	Medium, Large & X-Large

Back Panels



- Textured finish in RAL7032 Pebble Grey

Part No	Description	Size
GMCG1B	Back Panel	Small
GMCG16B	Back Panel	Intermediate
GMCG2B	Back Panel	Medium
GMCG3B	Back Panel	Large

STÖRNCH Anthracite Grey Premium Unit Covers



- Elegant and high quality housing for your air conditioning and heat pump units
- Durable and maintenance free powder coated aluminium
- The unit is neatly concealed without hindering its operational efficiency
- Wall mounted or free standing

Part No	Description	Size	External H (mm)	External W (mm)	External D (mm)
GMSC50A	Anthracite Unit Cover	Small	700	1000	500
GMSC51A	Anthracite Unit Cover	Medium	800	1100	550
GMSC52A	Anthracite Unit Cover	Large	1100	1200	650
GMSC53A	Anthracite Unit Cover	Extra Large	1300	1700	750
GMSC54A	Anthracite Unit Cover	Tower	1600	1200	650

Anthracite Grey Bottom Panels

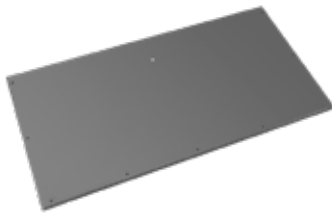

- With the optional bottom panel you can make a wall-mounted air conditioning housing with a closed bottom, but with a connection for the condensation water drain

Part No	Description	Size	Dimensions
GMSC60A	Bottom Panel	Small	500 x 1000mm
GMSC61A	Bottom Panel	Medium	550 x 1100mm
GMSC62A	Bottom Panel	Large	650 x 1200mm
GMSC63A	Bottom Panel	X-Large	750 x 1700mm
GMSC64A	Bottom Panel	Tower	650 x 1200mm

Anthracite Grey Back Panels

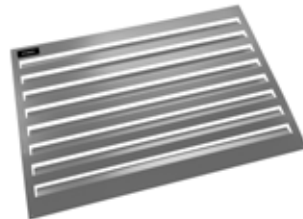

- With this extension, the cover is suitable for free-standing mounting with louvres all around

Part No	Description	Size	Dimensions
GMSC70A	Back Panel	Small	700 x 1000mm
GMSC71A	Back Panel	Medium	800 x 1100mm
GMSC72A	Back Panel	Large	1100 x 1200mm
GMSC73A	Back Panel	X-Large	1300 x 1700mm
GMSC74A	Back Panel	Tower	1200 x 1600mm

STÖRNCH Black Premium Unit Covers



- Elegant and high quality housing for your air conditioning and heat pump units
- Durable and maintenance free powder coated aluminium
- The unit is neatly concealed without hindering its operational efficiency
- Wall mounted or free standing

Part No	Description	Size	External H (mm)	External W (mm)	External D (mm)
GMSC50B	Black Unit Cover	Small	700	1000	500
GMSC51B	Black Unit Cover	Medium	800	1100	550
GMSC52B	Black Unit Cover	Large	1100	1200	650
GMSC53B	Black Unit Cover	Extra Large	1300	1700	750
GMSC54B	Black Unit Cover	Tower	1600	1200	650

Black Bottom Panels



- With the optional bottom panel you can make a wall-mounted air conditioning housing with a closed bottom, but with a connection for the condensation water drain

Part No	Description	Size	Dimensions
GMSC60B	Bottom Panel	Small	500 x 1000mm
GMSC61B	Bottom Panel	Medium	550 x 1100mm
GMSC62B	Bottom Panel	Large	650 x 1200mm
GMSC63B	Bottom Panel	X-Large	750 x 1700mm
GMSC64B	Bottom Panel	Tower	650 x 1200mm

Black Back Panels

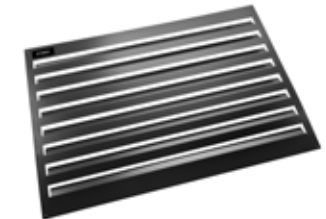

- With this extension, the cover is suitable for free-standing mounting with louvres all around

Part No	Description	Size	Dimensions
GMSC70B	Back Panel	Small	700 x 1000mm
GMSC71B	Back Panel	Medium	800 x 1100mm
GMSC72B	Back Panel	Large	1100 x 1200mm
GMSC73B	Back Panel	X-Large	1300 x 1700mm
GMSC74B	Back Panel	Tower	1200 x 1600mm

Condensing Unit Trays (Metal)



Part No	Description	Size
GMCT1	Metal Tray	800mm x 400mm
GMCT2	Metal Tray	1100mm x 400mm

- Attached to cantilever arms or condenser wall brackets
- c/w fixings
- Features outlet connection to 3/4" pipe

Condensing Unit Trays (Plastic)



- c/w clips for fitting to any brackets
- 15mm outlet connection

Part No	Description	Size
GMCT3	Plastic Tray	790mm x 390mm
GMCT4	Plastic Tray	940mm x 420mm

Ultralite Paving Slabs



Part No	Description	Size
GMVB10	Ultralite Paving Slab	600mm x 600mm
GMVB11	Ultralite Paving Slab	900mm x 400mm

- Lightweight paving slabs for mounting units
- Tough, durable and vibration-absorbing
- Weight +/- 6kg each
- Load capacity 270kgs
- Fibre-cement coated - looks and performs like a concrete paving slab

Vibromats



- Sound dampening properties
- Ideal for flat roofs & delicate surfaces
- Specialist anti-vibration mats for condensing and air handling units

Part No	Description	Size
GMVB1	Vibromat	600mm x 150mm x 30mm
GMVB3	Vibromat	1000mm x 500mm x 30mm

Rubber Tile



- Sound dampening properties
- Ideal for flat roofs & delicate surfaces
- Specialist anti-vibration mats for condensing and air handling units

Part No	Description	Size
GMVB4	Rubber Tile	500mm x 500mm x 45mm

Vibrostrip



- Sound dampening properties
- Ideal for flat roofs & delicate surfaces
- Specialist anti-vibration mats for condensing and air handling units

Part No	Description	Qty/Pk
GMVB5	Vibrostrip	1000mm x 75mm x 15mm

Anti-Vibration Pads

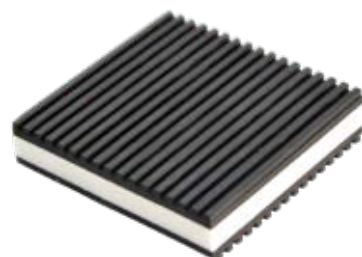

- Latest vibration dampening technology - far outperforms rubber and cork
- Composite foam centre
- Resistant to oils and chemicals
- 90° opposed ribbed sheets for static non-slip contact even in wet

Part No	Description	Size
GMVB32	Anti-Vibration Pad	100mm x 100mm x 22mm

Rubber Multipurpose Mounts - 20kg



- Manufactured from vulcanised UV resistant rubber with an M8 zinc plated thread on both ends
- Supplied complete with nuts and washers
- Very effective for mounting condensing units on brackets and cantilever arms etc

Part No	Description	Weight Rating	Size	Qty/pk
GMVB8	Rubber Mounts	20kg	(M8) 30x20mm	pk 4

Rubber Multipurpose Mounts - 40kg



- Manufactured from vulcanised UV resistant rubber with an M8 zinc plated thread on both ends
- Supplied complete with nuts and washers
- Very effective for mounting condensing units on brackets and cantilever arms etc

Part No	Description	Weight Rating	Size	Qty/pk
GMVB9	Rubber Mounts	40kg	(M8) 40x30mm	pk 4

VT Mounting Feet



- Manufactured in neoprene with mild steel inserts
- Ideal for condensing units, axial and centrifugal fans

Part No	Description	Weight Rating	Thread Size
GMVB15	Mounting Feet	9 - 18kg	M8

Part No	Description	Weight Rating	Thread Size
GMVB17	Mounting Feet	20 - 40kg	M8

STÖRNCH Fixings

Contents

Slotted Steel Channel	22 - 23
Channel End Caps	24
Channel Bracket Sets & Cantilever Arms	25
Channel Nuts & Washers	26
Channel Brackets	27 - 28
Nuts, Bolts & Washers	29
Hot Dip Galv Medium Duty Cable Tray	30 - 31
Light & Medium Duty Cable Tray	32 - 33
Medium Duty Cable Tray Fittings	34 - 35
Heavy Duty Cable Tray	36
Heavy Duty Cable Tray Fittings	37 - 38
Cable Tray Hangers	39
Studbite Tray Hangers	40
Studbite Trapeze Support System	41
Cable Tray Fixings	42
Basket Tray & Fixings	43 - 44
Studding & Fittings	45
Stud Hangers	46 - 47
Wedge Anchors	48
Wedge Nuts & Beam Clamps	49
Lindapters & Flange Clamps	50
Wire Hanging	51 - 52
Anchors & Fixings	53
Wall Fixings, Screws & Driver Bits	54 - 55



Heavy Duty Slotted Channel



41 x 41 mm

- Pre-galvanised
- 2.5mm wall thickness
- 11mm slots
- Used with channel accessories to build frames for the support/suspension of electrical and mechanical services

Part No	Description	Size
GMCN3	Heavy Duty Slotted Channel	41x41mm x 3mt
GMCN3SP	Heavy Duty Slotted Channel	41x41mm x 6mt

Light Duty Slotted Channel



41 x 41 mm

- Pre-galvanised
- 1.5mm wall thickness
- 11mm slots
- Used with channel accessories to build frames for the support/suspension of electrical and mechanical services

Part No	Description	Size
GMCN1	Light Duty Slotted Channel	41x41mm x 3mt

Heavy Duty Slotted Channel



41 x 21 mm

- Pre-galvanised
- 2.5mm wall thickness
- 11mm slots
- Used with channel accessories to build frames for the support/suspension of electrical and mechanical services

Part No	Description	Size
GMCN4	Heavy Duty Slotted Channel	41x21mm x 3mt

Light Duty Slotted Channel



41 x 21 mm

- Pre-galvanised
- 1.5mm wall thickness
- 11mm slots
- Used with channel accessories to build frames for the support/suspension of electrical and mechanical services

Part No	Description	Size
GMCN2	Light Duty Slotted Channel	41x21mm x 3mt



Heavy Duty Slotted Back-to-Back Channel



41 x 82 mm

- Pre-galvanised
- 2.5mm wall thickness
- 11mm slots
- Used with channel accessories to build frames for the support/suspension of electrical and mechanical services

Part No	Description	Size
GMCN3B	Back-to-Back Channel	41x82mm x 3mt
GMCN3B6	Back-to-Back Channel	41x82mm x 6mt

Deep Channel Sockets

STÖRNCH



- Fits easily inside strut channel to fix fastenings
- GMHS39 fixes M8 fastenings
- GMHS40 fixes M10 fastenings

Part No	Description	Size
GMHS39	Deep Channel Socket 1/2" Drive	13mm
GMHS40	Deep Channel Socket 1/2" Drive	17mm

STÖRNCH Channel End Caps 41x41mm

STÖRNCH



- Provides a pleasant aesthetic finish
- Prevents exposed sharp edges, meeting health & safety requirements

Part No	Description	Size	Qty/Pk
GMCN16B	Black End Cap	41mm x 41mm	pk 100

Part No	Description	Size	Qty/Pk
GMCN16G	Lt Grey End Cap	41mm x 41mm	pk 100
GMCN16W	White End Cap	41mm x 41mm	pk 100

STÖRNCH Channel End Caps 41x21mm

STÖRNCH



- Provides a pleasant aesthetic finish
- Prevents exposed sharp edges, meeting health & safety requirements

Part No	Description	Size	Qty/Pk
GMCN17B	Black End Cap	41mm x 21mm	pk 100

Part No	Description	Size	Qty/Pk
GMCN17G	Lt Grey End Cap	41mm x 21mm	pk 100
GMCN17W	White End Cap	41mm x 21mm	pk 100

STÖRNCH Light Duty Channel End Caps 41x21mm

STÖRNCH

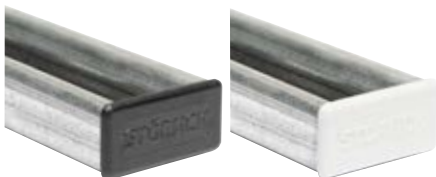

- Provides a pleasant aesthetic finish
- Prevents exposed sharp edges, meeting health & safety requirements

Part No	Description	Size
GMCNL17B	Light Duty Channel End Cap Black	41 x 21mm
GMCNL17W	Light Duty Channel End Cap White	41 x 21mm



STÖRNCH Ready-To-Go Bracket Sets

STÖRNCH
Condenser Support



- The STÖRNCH "Ready-to-go" set is a cantilever set flat packed with all the necessary fixings for an installation.
- Save time on site - time is money!

SET CONTAINS:

- 1 pair of Cantilever Arms
- End Caps
- Channel Nuts
- 2 Lengths of 41 x 41mm x 750mm H.D. Channel
- Rawlbolts
- Bolts and Washers



Part No	Description	Size	Weight
GMCN20	Ready-To-Go Bracket Set	450mm	160kg
GMCN21	Ready-To-Go Bracket Set	600mm	160kg
GMCN5	Ready-To-Go Bracket Set	750mm	160kg

Cantilever Bracket Arms



Part No	Description	Size
GMCN32	Cantilever Arm	300mm
GMCN18	Cantilever Arm	450mm
GMCN19	Cantilever Arm	600mm
GMCN31	Cantilever Arm	750mm
GMCN33	Cantilever Arm	900mm
GMCN36	Cantilever Arm	1000mm

- Hot-dip galvanised
- Used for pipework support and mounting air conditioning units to walls
- Can be used with channel using channel nuts

Part No	Description	Size
GMCN18D	Back-to-Back Cantilever Arm	450mm
GMCN19D	Back-to-Back Cantilever Arm	600mm

Channel Nuts - Plain

STÖRNCH



- Zinc plated (BZP)
- Used in channel support systems

Part No	Description	Size	Qty/Pk
GMCN22	Channel Nuts - Plain	M6	pk 100
GMCN23	Channel Nuts - Plain	M8	pk 100
GMCN24	Channel Nuts - Plain	M10	pk 100
GMCN43	Channel Nuts - Plain	M12	pk 100

Slide Nuts



- Square plate and channel nut in one
- Plastic component made of polyamide (PA6)

Part No	Description	Size	Qty/Pk
GMFX96-50	Slide Nuts	M8	pk 50
GMFX97-50	Slide Nuts	M10	pk 50

Channel Nuts - Short Spring

STÖRNCH



- Zinc plated (BZP)
- Perfect for shallow channel and fixing systems
- Quick and easy to insert and fix into channel

Part No	Description	Size	Qty/Pk
GMCN25	Channel Nuts - Short Spring	M6	pk 100
GMCN26	Channel Nuts - Short Spring	M8	pk 100
GMCN27	Channel Nuts - Short Spring	M10	pk 100

Square Plate Washers

STÖRNCH



- Zinc plated (BZP)

Part No	Description	Size	Qty/Pk
GMFX92	M8 Square Plate Washers	40 x 40 x 3mm	pk 100
GMFX93	M10 Square Plate Washers	40 x 40 x 3mm	pk 100

Channel Nuts - Long Spring

STÖRNCH



- Zinc plated (BZP)
- Perfect for deeper channel and fixing systems
- Quick and easy to insert and fix into channel

Part No	Description	Size	Qty/Pk
GMCN28	Channel Nuts - Long Spring	M6	pk 100
GMCN29	Channel Nuts - Long Spring	M8	pk 100
GMCN30	Channel Nuts - Long Spring	M10	pk 100

Heavy Duty Channel Plate Washers

STÖRNCH



- Zinc plated (BZP)

Part No	Description	Size	Qty/Pk
GMFX94	M8 Channel Plate Washers	40 x 40 x 5mm	pk 100
GMFX95	M10 Channel Plate Washers	40 x 40 x 5mm	pk 100

Angle Bracket - 2 Hole



- Hot-dip galvanised
- Used to join sections of channel together when installing channel support systems

Part No	Description
GMCN10	90° Angle Bracket - 2 Hole

Angle Bracket - 3 Hole



- Hot-dip galvanised
- Used to join sections of channel together when installing channel support systems

Part No	Description
GMCN10B	90° Angle Bracket - 3 Hole

Angle Bracket - 4 Hole



- Hot-dip galvanised
- Used to join sections of channel together when installing channel support systems

Part No	Description
GMCN11	90° Angle Bracket - 4 Hole

Obtuse Angle Bracket



- Hot-dip galvanised
- Used to join sections of channel together when installing channel support systems

Part No	Description
GMCN14	Obtuse Angle Bracket

Corner Plate Bracket - 3 Hole



- Hot-dip galvanised
- Used to join sections of channel together when installing channel support systems

Part No	Description
GMCN13B	Flat Corner Plate Bracket - 3 Hole

Tee Bracket - 4 Hole



- Hot-dip galvanised
- Used to join sections of channel together when installing channel support systems

Part No	Description
GMCN13	Tee Bracket - 4 Hole

Window Brackets



- Hot-dip galvanised
- For clamping channel to beams
- Designed to assist with a wide range of applications, involving mounting and supporting channel systems

Part No	Description	Size
GMCN7	Window Bracket c/w M10 Cone Point Bolt	41mm x 21mm
GMCN6	Window Bracket c/w M10 Cone Point Bolt	41mm x 41mm
GMCN60A	Window Bracket c/w M10 Cone Point Bolt	41mm x 82mm

Flat Plate Bracket - 4 Hole



- Hot-dip galvanised
- Used when installing channel support systems, to join sections of channel together

Part No	Description
GMCN12	Flat Plate Bracket - 4 Hole

Internal Channel Joiners



- Hot-dip galvanised
- Used when installing channel support systems, to join sections of channel together

Part No	Description	Size
GMCN8	Internal Channel Joiner	41mm x 41mm
GMCN9	Internal Channel Joiner	41mm x 21mm

Double Fix Base Plate



- Hot-dip galvanised
- Designed for use with channel
- The two holes in the baseplate are for fastening to the floor using anchors and bolts
- The two upright brace holes are for fastening to channel

Part No	Description	Size
GMCN15	Double Fix Base Plate	41mm x 41mm

Double Fix Base Plate



- Hot-dip galvanised
- Designed for use with channel
- The two holes in the baseplate are for fastening to the floor using anchors and bolts
- The four upright brace holes are for fastening to channel

Part No	Description	Size
GMCN60B	Double Fix Base Plate	41mm x 82mm

H.T. (High Tensile) Bolts



- High tensile 8.8
- Zinc plated (BZP)
- Fully threaded
- Conforms to DIN 933

Part No	Description	Size	Qty/Pk
GMFX50	H.T. Bolts	M8 x 20mm	pk 100
GMFX51	H.T. Bolts	M8 x 25mm	pk 100
GMFX52	H.T. Bolts	M8 x 30mm	pk 100
GMFX53	H.T. Bolts	M8 x 40mm	pk 100
GMFX58	H.T. Bolts	M10 x 20mm	pk 100
GMFX54	H.T. Bolts	M10 x 25mm	pk 100
GMFX55	H.T. Bolts	M10 x 30mm	pk 100
GMFX56	H.T. Bolts	M10 x 40mm	pk 100
GMFX57	H.T. Bolts	M10 x 60mm	pk 100

Penny Washers



- Zinc plated (BZP)
- Also known as repair washers or mudguard washers

Part No	Description	Size	Qty/Pk
GMFX83	Penny Washers	M6 x 25mm	pk 100
GMFX85	Penny Washers	M8 x 25mm	pk 100
GMFX86	Penny Washers	M8 x 30mm	pk 100
GMFX87	Penny Washers	M8 x 38mm	pk 100
GMFX89	Penny Washers	M10 x 25mm	pk 100
GMFX90	Penny Washers	M10 x 30mm	pk 100

Hex Nuts



- Zinc plated (BZP)
- For use with bolts and threaded rod
- Conforms to DIN 934

Part No	Description	Size	Qty/Pk
GMFX72	Hex Nuts	M6	pk 100
GMFX73	Hex Nuts	M8	pk 100
GMFX74	Hex Nuts	M10	pk 100
GMFX77	Hex Nuts	M12	pk 100

Serrated Flange Nuts



- Zinc plated (BZP)
- Larger clamping & locking force than a standard hex nut

Part No	Description	Size	Qty/Pk
GMFX79	Flange Nuts	M8	pk100
GMFX80	Flange Nuts	M10	pk100

M8 Form G Washers



- Zinc plated (BZP)
- Inside diameter 8.4mm
- Outside diameter 24mm
- Thickness 2mm

Part No	Description	Size	Qty/Pk
GMFX81	G Washer	M8	pk100

Hot Dip Galv Med Duty Cable Tray

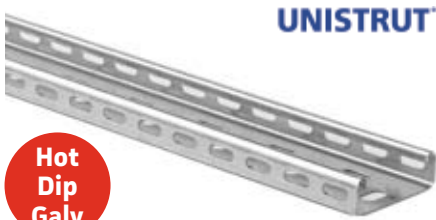

Hot Dip Galv

- Hot dip galvanised
- Medium duty return flange

Part No	Description	Size
GMGT1	Hot Dip Galv Med Duty Cable Tray	75mm (3") x 3mt

Hot Dip Galv Med Duty Cable Tray



Hot Dip Galv

- Hot dip galvanised
- Medium duty return flange

Part No	Description	Size
GMGT2	Hot Dip Galv Med Duty Cable Tray	100mm (4") x 3mt

Hot Dip Galv Med Duty Cable Tray



Hot Dip Galv

- Hot dip galvanised
- Medium duty return flange

Part No	Description	Size
GMGT3	Hot Dip Galv Med Duty Cable Tray	150mm (6") x 3mt

Hot Dip Galv Med Duty Cable Tray



Hot Dip Galv

- Hot dip galvanised
- Medium duty return flange

Part No	Description	Size
GMGT4	Hot Dip Galv Med Duty Cable Tray	225mm (9") x 3mt

Hot Dip Galv Med Duty Cable Tray



Hot Dip Galv

- Hot dip galvanised
- Medium duty return flange

Part No	Description	Size
GMGT5	Hot Dip Galv Med Duty Cable Tray	300mm (12") x 3mt

Hot Dip Galv Med Duty Cable Tray



Hot Dip Galv

- Hot dip galvanised
- Medium duty return flange

Part No	Description	Size
GMGT6	Hot Dip Galv Med Duty Cable Tray	450mm (18") x 3mt

Hot Dip Galv Med Duty Cable Tray



Hot Dip Galv

- Hot dip galvanised
- Medium duty return flange

Part No	Description	Size
GMGT7	Hot Dip Galv Med Duty Cable Tray	600mm (24") x 3mt

Hot Dip Galv MD Wrapover Couplers

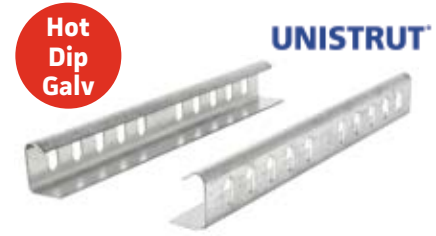

Hot Dip Galv

- For joining 2 lengths of medium duty cable tray on a straight run
- Hot dip galvanised
- Sold as a pair

Part No	Description	Qty/Pk
GMGT8W	Hot Dip Galv Med Duty Cable Tray Couplers	Pair



Pre-Galv Light Duty Cable Tray



- Pre-galvanised
- No return flange
- Flared ends for self-joining (no couplers required)

Part No	Description	Size
GMTR0	Light Duty Cable Tray	50mm (2") x 3mt

Pre-Galv Medium Duty Cable Tray



- Pre-galvanised
- Medium duty return flange

Part No	Description	Size
GMTR1	Medium Duty Cable Tray	75mm (3") x 3mt

Pre-Galv Medium Duty Cable Tray



- Pre-galvanised
- Medium duty return flange

Part No	Description	Size
GMTR2	Medium Duty Cable Tray	100mm (4") x 3mt

Pre-Galv Medium Duty Cable Tray



- Pre-galvanised
- Medium duty return flange

Part No	Description	Size
GMTR3	Medium Duty Cable Tray	150mm (6") x 3mt

Pre-Galv Medium Duty Cable Tray



- Pre-galvanised
- Medium duty return flange

Part No	Description	Size
GMTR4	Medium Duty Cable Tray	225mm (9") x 3mt

Pre-Galv Medium Duty Cable Tray



- Pre-galvanised
- Medium duty return flange

Part No	Description	Size
GMTR5	Medium Duty Cable Tray	300mm (12") x 3mt

Pre-Galv Medium Duty Cable Tray

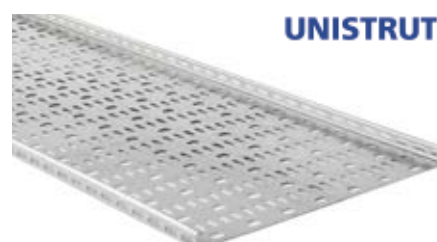

- Pre-galvanised
- Medium duty return flange

Part No	Description	Size
GMTR6	Medium Duty Cable Tray	450mm (18") x 3mt

Pre-Galv Medium Duty Cable Tray



- Pre-galvanised
- Medium duty return flange

Part No	Description	Size
GMTR7	Medium Duty Cable Tray	600mm (24") x 3mt

Straight Cable Tray Couplers



- For joining 2 lengths of medium duty cable tray on a straight run
- Pre-galvanised
- Sold as a pair

Part No	Description	Qty/Pk
GMTR8S	Straight Cable Tray Couplers	Pair

Medium Duty Wrapover Couplers



- For joining 2 lengths of medium duty cable tray on a straight run
- Pre-galvanised
- Sold as a pair

Part No	Description	Qty/Pk
GMTR8W	Medium Duty Cable Tray Couplers	Pair

TrayBite® Cable Tray Couplers & ThreadBite® Screws



- Self tapping ThreadBite screws replace the need for traditional nut and bolt fixing

- Time saving product - no longer requiring fiddly square nuts and spanners
- Wrapover coupler
- Only suitable for medium duty cable tray



Part No	Description	Qty/Pk
GMTR61	TrayBite Wrapover Couplers	10 Pairs
GMTR62	ThreadBite Screws	pk 250

Pre-Galv Medium Duty Cable Tray 90° Flat Bends



UNISTRUT

- Pre-galvanised
- Medium duty return flange

Part No	Description	Size
GMTR20	90° Flat Bend	100mm (4")
GMTR21	90° Flat Bend	150mm (6")
GMTR22	90° Flat Bend	225mm (9")

Part No	Description	Size
GMTR23	90° Flat Bend	300mm (12")
GMTR24	90° Flat Bend	450mm (18")
GMTR25	90° Flat Bend	600mm (24")

Pre-Galv Medium Duty Cable Tray 45° Flat Bends



UNISTRUT

- Pre-galvanised
- Medium duty return flange

Part No	Description	Size
GMMD45100	45° Flat Bend	100mm (4")
GMMD45150	45° Flat Bend	150mm (6")
GMMD45225	45° Flat Bend	225mm (9")

Part No	Description	Size
GMMD45300	45° Flat Bend	300mm (12")
GMMD45450	45° Flat Bend	450mm (18")
GMMD45600	45° Flat Bend	600mm (24")

Pre-Galv Medium Duty Cable Tray Equal Reducers



UNISTRUT

- Pre-galvanised
- Medium duty return flange

Part No	Description	Size
GMTR37	Equal Reducer	150mm - 100mm
GMTR38	Equal Reducer	225mm - 150mm
GMTR39	Equal Reducer	300mm - 225mm

Part No	Description	Size
GMTR40	Equal Reducer	450mm - 300mm
GMTR41	Equal Reducer	600mm - 450mm

Pre-Galv Medium Duty Cable Tray Equal Tees



UNISTRUT

- Pre-galvanised
- Medium duty return flange

Part No	Description	Size
GMTR28	Equal Tee	100mm (4")
GMTR29	Equal Tee	150mm (6")
GMTR30	Equal Tee	225mm (9")

Part No	Description	Size
GMTR31	Equal Tee	300mm (12")
GMTR32	Equal Tee	450mm (18")
GMTR33	Equal Tee	600mm (24")

Medium Duty Cable Tray Channel Clips



- Simply slip the clip into the channel and snap it over the return flange of the tray
- Removes the need for fiddly spring nuts and bolts, saving the installer time

Part No	Description	Qty/Pk
GMTR50	Cable Tray Channel Clips	pk 50



Pre-Galv Heavy Duty Cable Tray

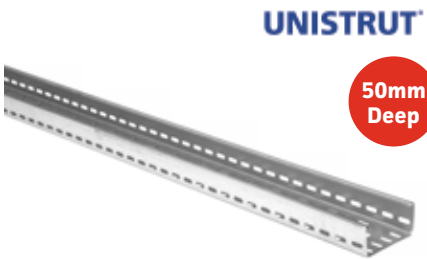

- Pre-galvanised
- Heavy duty return flange

Part No	Description	Size
GMHD100	Heavy Duty Cable Tray	100mm (4") x 3mt

Pre-Galv Heavy Duty Cable Tray

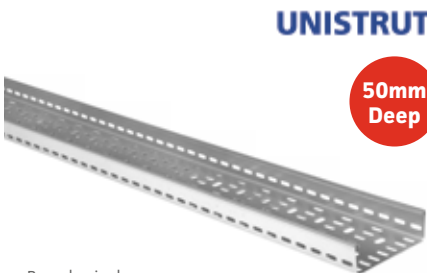

- Pre-galvanised
- Heavy duty return flange

Part No	Description	Size
GMHD150	Heavy Duty Cable Tray	150mm (6") x 3mt

Pre-Galv Heavy Duty Cable Tray



- Pre-galvanised
- Heavy duty return flange

Part No	Description	Size
GMHD225	Heavy Duty Cable Tray	225mm (9") x 3mt

Pre-Galv Heavy Duty Cable Tray

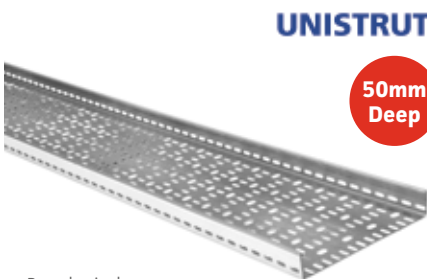

- Pre-galvanised
- Heavy duty return flange

Part No	Description	Size
GMHD300	Heavy Duty Cable Tray	300mm (12") x 3mt

Pre-Galv Heavy Duty Cable Tray

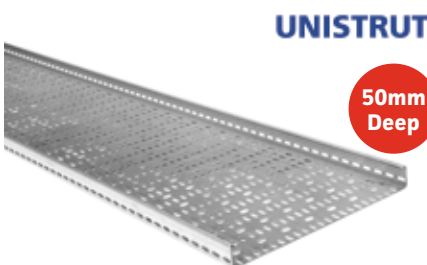

- Pre-galvanised
- Heavy duty return flange

Part No	Description	Size
GMHD450	Heavy Duty Cable Tray	450mm (18") x 3mt

Pre-Galv Heavy Duty Cable Tray

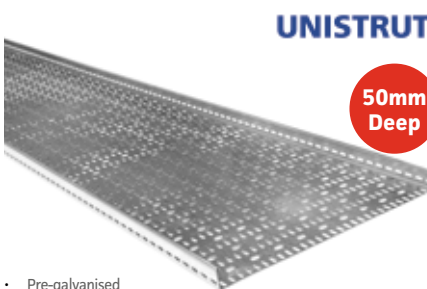

- Pre-galvanised
- Heavy duty return flange

Part No	Description	Size
GMHD600	Heavy Duty Cable Tray	600mm (24") x 3mt

Heavy Duty Wrapover Couplers



- For joining two lengths of heavy duty cable tray on a straight run
- Pre-galvanised
- Sold as a pair

Part No	Description	Qty/Pk
GMHDC	Heavy Duty Cable Tray Couplers	Pair

Heavy Duty Cable Tray Channel Clip

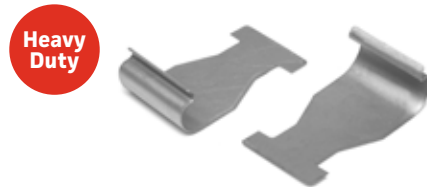

- This clip is used for quickly connecting heavy duty return flange cable tray to channel. Simply twist the clip into the channel and clip it over the side of the tray. Repeat on the other side, and job done!
- Zinc plated finish

Part No	Description	Qty/Pk
GMTR51-50	Heavy Duty Cable Tray Channel Clip	pk50

Pre-Galv Heavy Duty Cable Tray 90° Flat Bends



- Pre-galvanised
- Heavy duty return flange

Part No	Description	Size
GMHDB90100	90° Flat Bend	100mm (4")
GMHDB90150	90° Flat Bend	150mm (6")
GMHDB90225	90° Flat Bend	225mm (9")

Part No	Description	Size
GMHDB90300	90° Flat Bend	300mm (12")
GMHDB90450	90° Flat Bend	450mm (18")
GMHDB90600	90° Flat Bend	600mm (24")

Pre-Galv Heavy Duty Cable Tray 45° Flat Bends



- Pre-galvanised
- Heavy duty return flange

Part No	Description	Size
GMHD45100	45° Flat Bend	100mm (4")
GMHD45150	45° Flat Bend	150mm (6")
GMHD45225	45° Flat Bend	225mm (9")

Part No	Description	Size
GMHD45300	45° Flat Bend	300mm (12")
GMHD45450	45° Flat Bend	450mm (18")
GMHD45600	45° Flat Bend	600mm (24")

Pre-Galv Heavy Duty Cable Tray Equal Reducers

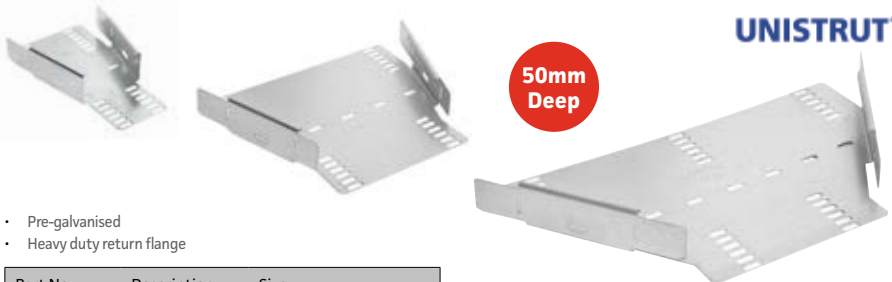

- Pre-galvanised
- Heavy duty return flange

Part No	Description	Size
GMHDR1510	Equal Reducer	150mm - 100mm
GMHDR2215	Equal Reducer	225mm - 150mm
GMHDR3022	Equal Reducer	300mm - 225mm

Part No	Description	Size
GMHDR4530	Equal Reducer	450mm - 300mm
GMHDR6045	Equal Reducer	600mm - 450mm

Pre-Galv Heavy Duty Cable Tray Equal Tees



- Pre-galvanised
- Heavy duty return flange

Part No	Description	Size
GMHDT100	Equal Tee	100mm (4")
GMHDT150	Equal Tee	150mm (6")
GMHDT225	Equal Tee	225mm (9")

Part No	Description	Size
GMHDT300	Equal Tee	300mm (12")
GMHDT450	Equal Tee	450mm (18")
GMHDT600	Equal Tee	600mm (24")

Cable Tray Stand Off Brackets

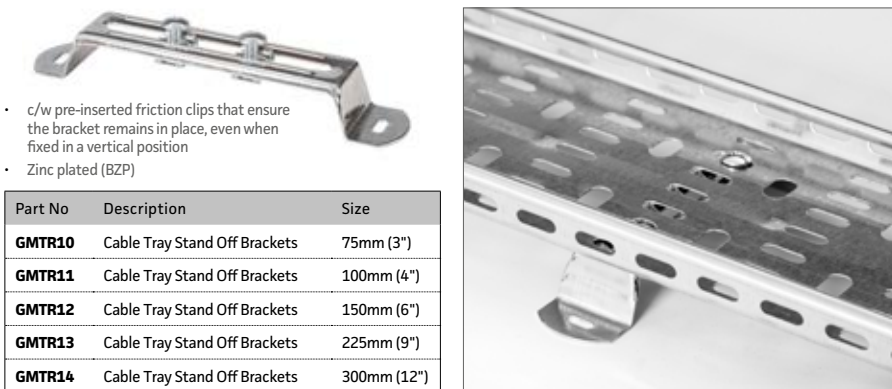

- c/w pre-inserted friction clips that ensure the bracket remains in place, even when fixed in a vertical position
- Zinc plated (BZP)

Part No	Description	Size
GMTR10	Cable Tray Stand Off Brackets	75mm (3")
GMTR11	Cable Tray Stand Off Brackets	100mm (4")
GMTR12	Cable Tray Stand Off Brackets	150mm (6")
GMTR13	Cable Tray Stand Off Brackets	225mm (9")
GMTR14	Cable Tray Stand Off Brackets	300mm (12")

Overhead Cable Tray Hangers



- Lightweight support for cable tray runs parallel to ceilings
- Fits overs strut, can be suspended from studding, or fixed directly to ceilings and walls

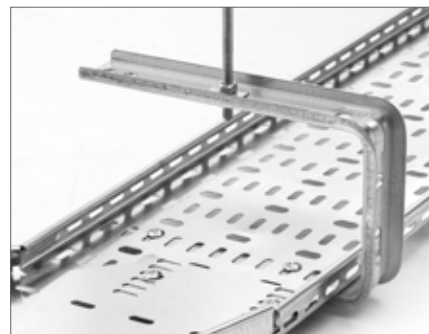

Part No	Description	Size
GMTR15	Overhead Cable Tray Hanger	100mm (4")
GMTR16	Overhead Cable Tray Hanger	150mm (6")
GMTR17	Overhead Cable Tray Hanger	225mm (9")
GMTR18	Overhead Cable Tray Hanger	300mm (12")

Unitrunk Cable Tray Hangers



- Pre-galvanised
- Used to support horizontal runs of cable tray, suspended from threaded rod



Part No	Description	Size
CMOTH100	Unitrunk Cable Tray Hanger	100mm (4")
CMOTH150	Unitrunk Cable Tray Hanger	150mm (6")
CMOTH225	Unitrunk Cable Tray Hanger	225mm (9")
CMOTH300	Unitrunk Cable Tray Hanger	300mm (12")

Platform Overhead Cable Tray Hangers

- Pre-galvanised
- Used to support runs of cable tray
- Hung from a single threaded rod

Part No	Description	Size
GMRHG100	Platform Overhead Tray Hanger	100mm (4")
GMRHG150	Platform Overhead Tray Hanger	150mm (6")
GMRHG225	Platform Overhead Tray Hanger	225mm (9")
GMRHG300	Platform Overhead Tray Hanger	300mm (12")



StudBite Single Stud Hanger



Use With ThreadBite Screws

- Multiple fixing options
- Easily adjustable up and down stud
- Use ThreadBite Screws to fix cable tray directly to the hanger

Part No	Description	Size
GMSB9	StudBite Single Stud Hanger	100mm (4")

StudBite Single Stud Hanger



Use With ThreadBite Screws

- Multiple fixing options
- Easily adjustable up and down stud
- Use ThreadBite Screws to fix cable tray directly to the hanger

Part No	Description	Size
GMSB10	StudBite Single Stud Hanger	150mm (6")

StudBite Single Stud Hanger



Use With ThreadBite Screws

- Multiple fixing options
- Easily adjustable up and down stud
- Use ThreadBite Screws to fix cable tray directly to the hanger

Part No	Description	Size
GMSB11	StudBite Single Stud Hanger	225mm (9")

StudBite Single Stud Hanger



Use With ThreadBite Screws

- Multiple fixing options
- Easily adjustable up and down stud
- Use ThreadBite Screws to fix cable tray directly to the hanger

Part No	Description	Size
GMSB12	StudBite Single Stud Hanger	300mm (12")

StudBite Retro-Fit Clamp



- Unique retrofit clip can fix straight to side of M8/M10 existing stud

Part No	Description	Qty/Pk
GMSB13	Optional Retro-Fit Clamp	Each

StudBite Basket Tray Clamp



- The Basket Tray Clamp is used to fix basket tray to the hanger using the ThreadBite Screws

Part No	Description	Qty/Pk
GMSB14	Basket Tray Clamp	Each

StudBite Trapeze Support Kits

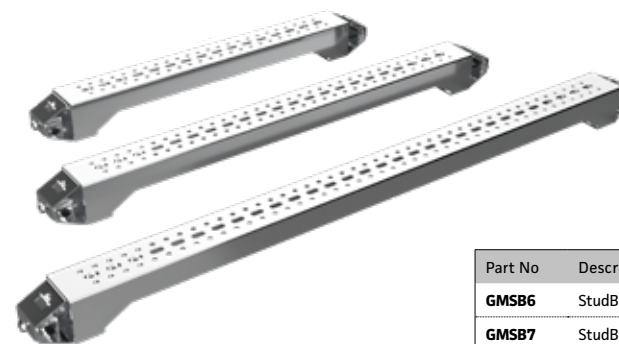

- Building multi-tier trapeze supports has never been easier
- No nuts, washers or channel end caps needed
- No need to deburr stud ends
- Easily adjustable up and down stud
- Use ThreadBite Screws to fix cable tray directly to channel support.
- Trapeze Support Kits include 2 end brackets

Part No	Description	Size
GMSB6	StudBite Trapeze Support Kit	300mm (12")
GMSB7	StudBite Trapeze Support Kit	450mm (18")
GMSB8	StudBite Trapeze Support Kit	600mm (24")

Trapeze Support Adapters



- Building trapeze support brackets onsite or offsite made easy.
- By inverting this product it can be used as support in a traditional channel trapeze
- No nuts, washers or channel end caps needed!
- Easily adjustable up and down stud

Part No	Description	Qty/Pk
GMSB3	Support Adapters	Pair

Inverted Channel Adapter Clamp



- Compatible with M8/M10 stud and deep/shallow channel, StudBite Channel-to-Stud Adapters have been specifically designed to work with (not replace) tried and trusted industry-standard products

Part No	Description	Qty/Pk
GMSB4	Inverted Channel Adapter Clamp	Each

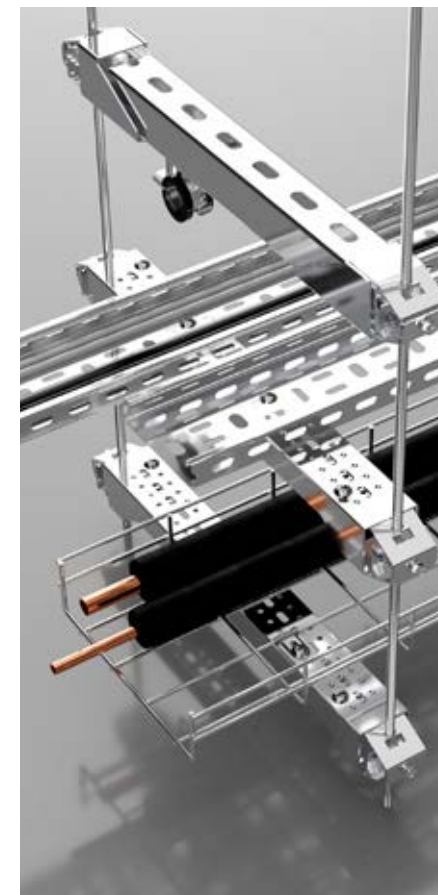

PZ (Pozi) Tray Bolts & Serrated Flange Nuts



STÖRNCH

Part No	Description	Size	Qty/Pk
GMTB616	Tray Bolts & Nuts	M6 x 16mm	pk 200
GMTB620	Tray Bolts & Nuts	M6 x 20mm	pk 200
GMTB625	Tray Bolts & Nuts	M6 x 25mm	pk 200

- Zinc plated (BZP)
- The flange eliminates using a washer in some installs saving time for the installer
- Serrations on the flange bind tightly to the material

Roofing Bolts & Nuts



STÖRNCH

- Zinc plated (BZP)
- Fully threaded
- Square nuts included

Part No	Description	Size	Qty/Pk
GMFX60	Roofing Bolts & Nuts	M6 x 16mm	pk 200
GMFX61	Roofing Bolts & Nuts	M6 x 20mm	pk 200
GMFX62	Roofing Bolts & Nuts	M6 x 25mm	pk 200

EB100 Unistrut Earth Strap



UNISTRUT

- Zinc plated
- M10 hole size

Part No	Description	Qty/Pk
GMTR54	EB100 Unistrut Earth Strap	pk 10



Quik-Click Basket Tray



marco
cablemanagement

- Comes c/w pre-fixed couplers, enabling rapid installation and joining of lengths
- Zinc plated (BZP)

Part No	Description	Size
GMBTR100M	Quik-Click Basket Tray	100mm x 55mm x 3mt

Quik-Click Basket Tray



marco
cablemanagement

- Comes c/w pre-fixed couplers, enabling rapid installation and joining of lengths
- Zinc plated (BZP)

Part No	Description	Size
GMBTR150M	Quik-Click Basket Tray	150mm x 55mm x 3mt

Quik-Click Basket Tray



marco
cablemanagement

- Comes c/w pre-fixed couplers, enabling rapid installation and joining of lengths
- Zinc plated (BZP)

Part No	Description	Size
GMBTR200M	Quik-Click Basket Tray	200mm x 55mm x 3mt

Quik-Click Basket Tray



marco
cablemanagement

- Comes c/w pre-fixed couplers, enabling rapid installation and joining of lengths
- Zinc plated (BZP)

Part No	Description	Size
GMBTR300M	Quik-Click Basket Tray	300mm x 55mm x 3mt

Quik-Click Basket Tray



marco
cablemanagement

- Comes c/w pre-fixed couplers, enabling rapid installation and joining of lengths
- Zinc plated (BZP)

Part No	Description	Size
GMBTR400M	Quik-Click Basket Tray	400mm x 55mm x 3mt

Quik-Click Basket Tray



marco
cablemanagement

- Comes c/w pre-fixed couplers, enabling rapid installation and joining of lengths
- Zinc plated (BZP)

Part No	Description	Size
GMBTR600M	Quik-Click Basket Tray	600mm x 55mm x 3mt

Central Suspension Hanger



- Used to suspend cable tray from threaded rod (up to M10)
- Fast and simple installation

Part No	Description	Qty/Pk
GMBTR18M	Central Suspension Hangers	pk 25

Fast-Fix Universal Strut Clip



- Allows basket tray to be fastened to channel both quickly and easily
- Made secure with one turn of a screwdriver
- Eliminates the need for any special tools
- c/w appropriate screwdriver

Part No	Description	Qty/Pk
GMBTR22M	Fast-Fix Universal Strut Clips	pk 50

Nut Bolt Clamp Assembly

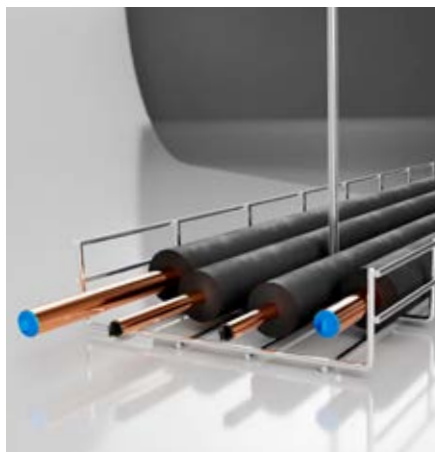
- Used when coupling two pieces of basket tray together
- Easy to install and remove if necessary
- Zinc plated (BZP)

Part No	Description	Qty/Pk
GMBTR23M	Nut Bolt Clamp Assembly	pk 50

BZP Studding/Threaded Rods



- Zinc plated (BZP)
- Common fixing for support systems, and used for a variety of applications

Part No	Description	Qty/Pk
GMCN34	M8 x 3mt Studding/Threaded Rod	Each
GMCN35	M10 x 3mt Studding/Threaded Rod	Each
GMCN40	M12 x 3mt Studding/Threaded Rod	Each

Studding End Caps - Black



- Protects the studding end from impact
- Provides a pleasant aesthetic finish
- Prevents exposed sharp edges

Part No	Description	Colour	Qty/Pk
GMCN41B	M8 Studding End Caps	Black	pk 100
GMCN42B	M10 Studding End Caps	Black	pk 100

Studding End Caps - Grey



- Protects the studding end from impact
- Provides a pleasant aesthetic finish
- Prevents exposed sharp edges

Part No	Description	Colour	Qty/Pk
GMCN41G	M8 Studding End Caps	Light Grey	pk 100
GMCN42G	M10 Studding End Caps	Light Grey	pk 100

Studding End Caps - White



- Protects the studding end from impact
- Provides a pleasant aesthetic finish
- Prevents exposed sharp edges

Part No	Description	Colour	Qty/Pk
GMCN41W	M8 Studding End Caps White	White	pk 100
GMCN42W	M10 Studding End Caps White	White	pk 100

Studding Connectors



- Provides a fast and economic connection for two lengths of studding
- Zinc plated (BZP)
- Can also be used for a number of applications where a taller nut is required

Part No	Description	Qty/Pk
GMCN37-25	M8 Studding Connectors	pk 25
GMCN38-25	M10 Studding Connectors	pk 25

Munson Base



- Used to attached studding to a flat surface
- Dual tapped to accept M8 or M10 threads
- Zinc plated (BZP)

Part No	Description	Qty/Pk
GMJ12A-25	Dual Tapped Munson Bases BZP	pk 25

Concrete Screw Stud Hangers

STÖRNCH



**M8/
M10
Concrete**

- Setting and installation in one working operation saves time
- Completely removable therefore suitable for temporary fixings
- M8/M10 dual tapped connector
- Drill 6mm hole. Must be drilled to the correct depth

Part No	Description	Size	Hole Size	Qty/Pk
GMFX103-100	Stud Hanger	M8 x 35mm	6mm	pk 100
GMFX104-100	Stud Hanger	M8 x 55mm	6mm	pk 100

Hammer-In Stud Hanger



**M8/
M10
Concrete**

- The Dual Thread allows for the use of M8 or M10 threaded rod with the need for only one socket
- Auto expanding action
- Fast and secure Installation
- No torque wrench required
- Hole size 6mm

Part No	Description	Size	Qty/Pk
GMFX105-100	Stud Hanger	M8/M10 x 30mm	pk 100

Wood Fixing Vertical Stud Hanger



**M8
Wood**

- An internally threaded socket for hanging rods vertically in wood
- Inserted using the GMFX127-100 Setting Tool

Part No	Description	Size	Qty/Pk
GMFX117-100	Stud Hanger	M8 x 25mm	pk 100

Wood Fixing Vertical Stud Hanger



**M10
Wood**

- An internally threaded socket for hanging rods vertically in wood
- Inserted using the GMFX127-100 Setting Tool

Part No	Description	Size	Qty/Pk
GMFX123-50	Stud Hanger	M10 x 63mm	pk 50

Metal Fixing Vertical Stud Hangers



**M8
Metal**

- An internally threaded socket for hanging rods vertically in light section steel
- Inserted using the GMFX127-100 Setting Tool

Part No	Description	Size	Qty/Pk
GMFX106-100	Stud Hanger	M8 x 25mm	pk 100
GMFX107-100	Stud Hanger	M8 x 38mm	pk 100

Metal Fixing Vertical Stud Hangers



**M10
Metal**

- An internally threaded socket for hanging rods vertically in light section steel
- Inserted using the GMFX127-100 Setting Tool

Part No	Description	Size	Qty/Pk
GMFX111-100	Stud Hanger	M10 x 25mm	pk 100
GMFX112-100	Stud Hanger	M10 x 38mm	pk 100

Wood Fixing Horizontal Stud Hanger



**M8
Wood**

- An internally threaded socket for hanging rods in wood
- Inserted using the GMFX127-100 Setting Tool

Part No	Description	Size	Qty/Pk
GMFX124-100	Stud Hanger	M8 x 25mm	pk 100

Wood Fixing Horizontal Stud Hangers



**M10
Wood**

- An internally threaded socket for hanging rods in wood
- Inserted using the GMFX127-100 Setting Tool

Part No	Description	Size	Qty/Pk
GMFX125-100	Stud Hanger	M10 x 25mm	pk 100
GMFX126-100	Stud Hanger	M10 x 50mm	pk 100

Metal Fixing Horizontal Stud Hanger



**M8
Metal**

- An internally threaded socket for hanging rods in light section steel
- Inserted using the GMFX127-100 Setting Tool

Part No	Description	Size	Qty/Pk
GMFX113-100	Stud Hanger	M8 x 25mm	pk 100

Metal Fixing Horizontal Stud Hangers



**M10
Metal**

- An internally threaded socket for hanging rods in light section steel
- Inserted using the GMFX127-100 Setting Tool

Part No	Description	Size	Qty/Pk
GMFX115-100	Stud Hanger	M10 x 25mm	pk 100
GMFX116-100	Stud Hanger	M10 x 38mm	pk 100

Setting Tool for Screw Stud Hangers



**For all
driver bits
see page
236**

- A 1/2" socket drive for setting rod hangers

Part No	Description	Qty/Pk
GMFX127-100	Setting Tool for Stud Hanger	Each

Chemical Resin



- For fixing studding into brick and blockwork
- Use with standard silicone gun
- High load capacity
- Expansion free

Part No	Description	Size
GMFX118	Polyester Resin - Styrene Free	300ml

Wedge Anchors

STÖRNCH

- Internally threaded to be used with threaded stud or bolts
- Easy to install using a Wedge Anchor Punch
- Slotted sleeve and internal wedge component together facilitate easy setting and expansion
- M8 = 30mm long
- M10 = 40mm long



Part No	Description	Hole Size	Qty/Pk
GMFX10	M8 Wedge Anchor	10mm	pk 100
GMFX11	M10 Wedge Anchor	12mm	pk 100

Wedge Anchors c/w Rim

STÖRNCH

- Internally threaded to be used with threaded stud or bolts
- Easy to install using a Wedge anchor punch
- Slotted sleeve and internal wedge component together facilitate easy setting and expansion
- M8 = 30mm long
- M10 = 40mm long



Part No	Description	Hole Size	Qty/Pk
GMFX18	M8 Wedge Anchor c/w Rim	10mm	pk 100
GMFX12	M10 Wedge Anchor c/w Rim	12mm	pk 50

SDS Drill Bit with Stop

- Allows you to drill to the correct depth for wedge anchors every time
- Suitable for M8 wedge anchors (GMFX10 & GMFX18)
- Not for M10 wedge anchors



Part No	Description	Size
GMDS20	SDS Drill Bit c/w Stop	10.0mm x 30mm Depth

Wedge Anchor Punch

- For the manual installation of wedge anchors
- Ideal for rapid, repetitive installations



Part No	Description	Size	Qty/Pk
GMFX16	Wedge Anchor Punch	M8	Each
GMFX17	Wedge Anchor Punch	M10	Each

M8 Wedge Anchor Punch

M8

- Punch for M8 wedge anchors
- Complete with built in hand guard



Part No	Description	Size	Qty/Pk
GMWAP1	Wedge Anchor Punch	M8	Each

M10 Wedge Anchor Punch

M10

- Punch for M10 wedge anchors
- Complete with built in hand guard



Part No	Description	Size	Qty/Pk
GMWAP2	Wedge Anchor Punch	M10	Each

Wedge Nuts

STÖRNCH

- To suit ribbed and composite floor decking
- Fitted easily and securely by hand
- Zinc plated (BZP)

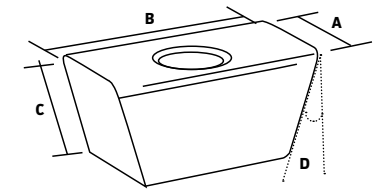

Part No	Description	Stud Size	DIM A	DIM B	DIM C	Angle D	Qty/Pk
GMFX75	Wedge Nuts	M8	12.5mm	25mm	13mm	15°	pk 100
GMFX76	Wedge Nuts	M10	12.5mm	25mm	13mm	15°	pk 100

Mini Wedge Nut

STÖRNCH

- To suit ribbed and composite floor decking
- Fitted easily and securely by hand
- Zinc plated (BZP)

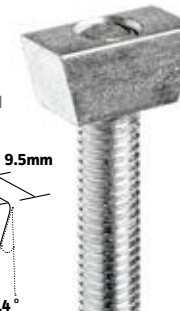
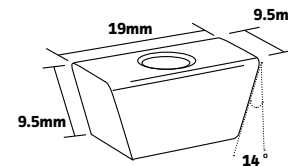

Part No	Description	Stud Size	Qty/Pk
GMFX150	Mini Wedge Nuts	M8	pk 100

Beam Clamp (Purlin Clip)

- For fixing to vertical flanges
- For threaded rod up to M10
- Suitable for a wide range of purlin sections



Part No	Description	Size	Qty/Pk
GMFX42	Beam Clamp (Purlin Clip)	M8/M10	Each

M8 Threaded Rod Hanger

- c/w threaded rod holder
- The rod height is adjustable by screwing up or down



Part No	Description	Size	Qty/Pk
GMFX49-100	Threaded Rod Hanger	M8	pk 100

Vertical Beam Clips

STÖRNCH

- For quick and easy fixing to vertical flanges
- The rod height is adjustable by screwing up or down



Part No	Description	Size	Qty/Pk
GMFX43-50	Vertical Beam Clips	M8	pk 50
GMFX44-50	Vertical Beam Clips	M10	pk 50

Lindapter TR60



- The Type TR60 is designed for TR60+ and TR80+ profiles manufactured by Structural Metal Decks
- Zinc plated (BZP)

Part No	Description	Size	Qty/Pk
GMFX163-50	Lindapter TR60	M8	pk 50
GMFX164-50	Lindapter TR60	M10	pk 50

Lindapter Alphawedge



- The Alphawedge is designed for Ribdeck E60 manufactured by Hare Decking
- Zinc plated (BZP)

Part No	Description	Size	Qty/Pk
GMFX160-50	Lindapter Alphawedge	M8	pk 50
GMFX161-50	Lindapter Alphawedge	M10	pk 50

Lindapter MW2 Multiwedge 2



- The Multiwedge 2 is designed for Multideck 60 and Multideck 80 profiles, manufactured by Kingspan Structural Products
- Zinc plated (BZP)

Part No	Description	Size	Qty/Pk
GMFX162-50	Lindapter MW2	M8	pk 50
GMFX48-50	Lindapter MW2	M10	pk 50

Flange Clamp



- Suitable for parallel or tapered flange beams
- Supplied with drilled hole for hanging studding

Part No	Description	Size	Qty/Pk
GMFX40	Flange Clamp	M8/M10	Each
GMFX41	Flange Clamp	M12	Each



Wire Ropes & Wire Rope Tool



- Cut to length wire rope system
- 6 times quicker to install than with strut and stud

Part No	Description	Size	Roll Length
GMVX106	No. 10 Wire Rope	50kg	100mt
GMVX107	No. 20 Wire Rope	120kg	100mt
GMVX112	Wire Rope Cutter		

Wire Rope Clutchers



- Simple system for rapid suspension of ductwork, cable tray, lighting & units etc
- Use GMVX101 - with No.10 Wire Rope
- Use GMVX102 - with No.20 Wire Rope

Part No	Description	Size	Qty/Pk
GMVX101	No. 10 Clutchers	50kg	pk 10
GMVX102	No. 20 Clutchers	120kg	pk 10

Wire Hanger



- Zinc and yellow passivated
- Drill a 6mm hole, to a minimum of 40mm depth
- Hammer-in, pull-down expansion
- Expansion anchor for securing suspension wires to concrete and most masonry

Part No	Description	Size	Qty/Pk
GMWH	Wire Hanger	6mm x 55mm	pk100

Zip-Clip Knock-in Anchor



- Hammer-in fixing
- Designed to fix wire suspension to cracked & non cracked concrete ceilings
- Drill a 6mm hole, to a minimum of 35mm depth
- BS8539 compliant

Part No	Description	Qty/Pk
GMVX120	Zip-Clip Knock-in Anchor	pk 50

Folded Eye Bolt



- A bolt with a loop at one end, used for light duty suspension applications including tensioning wire
- c/w nut
- Zinc plated (BZP)

Part No	Description	Size	Qty/Pk
GMFX136	Folded Eye Bolt	M8 x 80mm	Each

Cast Eye Bolt



- Suitable for a variety of applications, and designed to provide a multi-purpose circular fixture for tensioning wires, securing loads & lifting operations
- M8 threaded shaft

Part No	Description	Size	Qty/Pk
GMFX71	Cast Eye Bolt	M8	Each

Looped Gripple



- Ideal for looping around purlins, beams and roof trusses etc
- Comes as a ready-to-use kit with wire and Gripple clutches

Part No	Description	Size	Qty/Pk
GMVX37	No 2 Looped Gripple	1mt	pk 10
GMVX38	No 2 Looped Gripple	2mt	pk 10

Suspension Banding



- Easily cut and bent for hanging and supporting applications
- Pre-galvanised
- Multi-purpose fixing band

Part No	Description	Roll Size
GMVX30	Suspension Banding	17mm x 10mt

Black Patent Banding



- Pre-perforated for fixing using screws, nails or bolts
- Corrosion-resistant black plastic coating
- Easy to cut and bend for securing and supporting cable, trunking and ducting

Part No	Description	Roll Size
GMND	Round Black Patent Banding	12mm x 10mt

Black Hook & Loop Tape (Velcro)



- Makes re-adjustment of pipework effortless
- For permanent or temporary fixing
- Simply cut to any length
- Back-to-back hook and loop tape that fastens to itself

Part No	Description	Size
GMHL1625	Black Hook & Loop Tape	16mm x 25mt

Hose Banding & Locks



- 9mm continuously threaded stainless steel band
- Simply cut to any length

Part No	Description	Roll Size
GMVA1	Hose Banding	30mt Reel
GMVA2	Hose Banding Locks	pk 50

Quick Release Hose Clips



- Quick release for rapid application and removal

Part No	Description	Size
GMVA3	Quick Release Hose Clips	60mm - 180mm
GMVA4	Quick Release Hose Clips	60mm - 325mm

Rubber Ankernuts



- Suitable for anti-vibration and noise dampening in plasterboard, concrete, wood and potted ceilings

Part No	Description	Size	Hole Size	Qty/Pk
GMFX7-50	Rubber Ankernuts	M8 x 25mm	16mm	pk 50
GMFX8-50	Rubber Ankernuts	M8 x 50mm	18mm	pk 50
GMFX9-25	Rubber Ankernuts	M10 x 55mm	20mm	pk 25

Loose Bolt Shield Anchors



- For use in concrete, hollow-core slabs, flooring blocks and ceramics
- 10L = 10mm fixing capacity

Part No	Description	Size	Hole Size	Qty/Pk
GMFX1-25	Shield Anchors	M810L	14mm	pk 25
GMFX2-25	Shield Anchors	M1010L	16mm	pk 25

Projection Shield Anchors



- 10P = 10mm fixing capacity
- 15P = 15mm fixing capacity
- 60P = 60mm fixing capacity

- These operate in the same way as Loose Bolt Shield Anchors, but come with a projecting stud

Part No	Description	Size	Hole Size	Qty/Pk
GMFX3-25	Projection Shield Anchors	M810P	14mm	pk 25
GMFX4-25	Projection Shield Anchors	M1015P	16mm	pk 25
GMFX19	Projection Shield Anchors	M1060P	16mm	Each

Concrete Screws



- Completely removable, therefore suitable for temporary fixings
- Serrations on the thread make them easy to screw in
- Re-usability of the screw reduces cost
- Must be drilled to the correct depth

For all driver bits see page 236



Part No	Description	Size	Hole Size	Qty/Pk
GMFX110-100	Concrete Screw	6 x 50mm	5mm	pk 100
GMFX108-100	Concrete Screw	8 x 75mm	6mm	pk 100
GMFX109-100	Concrete Screw	10 x 75mm	8mm	pk 100

8mm head
GMFX110-100

15mm head
GMFX109-100

10mm head
GMFX108-100

Hammer-In Plasterboard Fixings

STÖRNCH



- No drilling needed
- Anti-rotating design
- Hammer-in for medium applications
- Supplied with screws

Part No	Description	Qty/Pk
GMFX114	Hammer-In Plugs	pk 200

Aluminium Plasterboard Fixing

STÖRNCH



- Flange prevents accidental push through in plasterboard
- No drill required - simply pierce paper skin and screw home.
- Ideal for use with either a power or manual Pozidrive screwdriver
- Supplied with screws

Part No	Description	Qty/Pk
GMFX13	Aluminium Plasterboard Fixing	pk 100

Spring Toggles

STÖRNCH



- Cavity wall & plasterboard fixings
- GMFX45 for use with M8 studding

Part No	Description	Hole Size	Qty/Pk
GMFX15-50	M6x75mm Spring Toggles	18mm	pk 50
GMFX45	M8 Toggle Head Only	22mm	Each

Nylon Plugs

STÖRNCH



- Heavily ribbed design improves pull-out strength
- Suitable for coach screws

Part No	Description	Hole Size	Qty/Pk
GMFX78	Nylon Plugs	10.0mm	pk 100

Wall Plugs



- Two-way expansion mechanism provides a strong anchorage in solid base materials
- Red plugs for 8g screws
- Brown plugs for 10g screws

Part No	Description	Hole Size	Qty/Pk
GMFX37	Red Plugs	5.5mm	pk 100
GMFX38	Brown Plugs	7.0mm	pk 100

Hex Coach Screws

STÖRNCH



- Can be used with nylon plugs, or screwed directly into timber
- Zinc plated (BZP)

Part No	Description	Size	Qty/Pk
GMFX30	Hex Coach Screws	M8 x 60mm	pk 100

Bolt Screw



- Woodscrew thread at one end and machine screw thread at the other
- Zinc plated (BZP)

Part No	Description	Size	Qty/Pk
GMFX68	Bolt Screw	M8 x 80mm	Each

Self Drill Screws - Square Drive

STÖRNCH



- Self drill
- Self tapping
- Zinc plated (BZP)
- c/w driver bit

Part No	Description	Size	Qty/Pk
GMFX65	Square Drive Pan Head	4.2 x 13mm	pk 1000
GMFX67	Square Drive Pan Head	4.2 x 19mm	pk 1000
GMFX134	Square Driver Bit		Each

Countersunk Pozi Woodscrews

STÖRNCH



- A single thread woodscrew, mainly used in various types of timber and man-made boards, or in masonry with a plastic plug

Part No	Description	Imperial	Metric	Qty/Pk
GMFX20	Woodscrews	8 x 1"	4.0 x 25mm	pk 200
GMFX21	Woodscrews	8 x 1 ¼"	4.0 x 30mm	pk 200
GMFX22	Woodscrews	8 x 1 ½"	4.0 x 40mm	pk 200
GMFX23	Woodscrews	8 x 2"	4.0 x 50mm	pk 200
GMFX25	Woodscrews	10 x 1 ½"	5.0 x 40mm	pk 200
GMFX26	Woodscrews	10 x 2"	5.0 x 50mm	pk 200
GMFX27	Woodscrews	10 x 2 ½"	5.0 x 60mm	pk 200
GMFX101	Woodscrews	10 x 3"	5.0 x 80mm	pk 200
GMFX66	Woodscrews	10 x 4"	5.0 x 100mm	pk 100
GMH550	PZ2 Impact Driver Bits			pk 10

Self Drill Screws - Wafer Head

STÖRNCH



- Self drill
- Self tapping
- Zinc plated (BZP)
- c/w driver bit

Part No	Description	Size	Qty/Pk
GMFX190	Self Drill Screws - Phillips	4.2 x 13mm	pk 1000
GMFX192	Self Drill Screws - Phillips	4.2 x 25mm	pk 1000

Self Drill Screws - Hex Head

STÖRNCH



- Self drill
- Self tapping
- Zinc plated (BZP)
- Driver Bit sold separately (GMFX35)

Part No	Description	Size	Qty/Pk
GMFX102	Self Drill Hex Head	4.2 x 13mm	pk 1000
GMFX34	Self Drill Hex Head	4.2 x 19mm	pk 1000
GMFX35	Magnetic Hex Driver Bit	7mm	Each

Pipe Clips & Clamps

Contents

Cushion Clamps	57
QPC Clips	58
Channel Clips	59
Tie Base Clips	60
Stud Clips for Drain	61
Stud Clips	62
Stud Clips Selector Guide	63
Suspender Clips	64
Grip Lock & Grip Fit Clamps	65
3 Pipe Stud Clips & Rubber Lined Clamps	66
Brass Pipe Rings & Clips	67

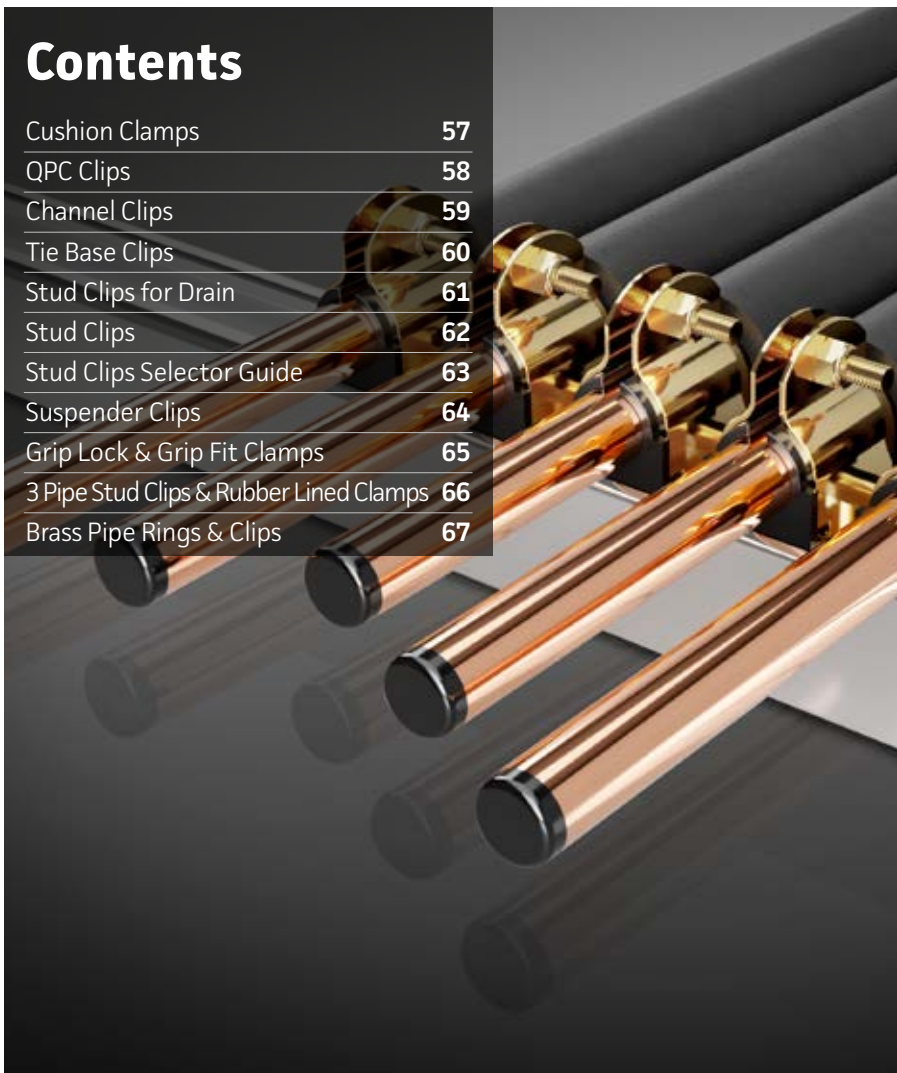

Cushion Clamps

STÖRNCH



STÖRNCH



STÖRNCH



- Channel clip ideal for bigger commercial air conditioning and refrigeration installations
- Insulates against heat loss and reduces vibration
- Quick to install with lock nuts
- Supports individual pipes in a thermo-rubber cushion between two metal plates
- Thermo-rubber cushion insert withstands maximum temperature of 130°C (zinc bracket 1000°C)

Part No	Description	Size	Qty/Pk
GMIC1	Cushion Clamps	¼"	pk 10
GMIC2	Cushion Clamps	⅜"	pk 10
GMIC3	Cushion Clamps	½"	pk 10
GMIC4	Cushion Clamps	⅝"	pk 10
GMIC5	Cushion Clamps	¾"	pk 10
GMIC6	Cushion Clamps	⅞"	pk 10
GMIC7	Cushion Clamps	1-¼"	pk 10
GMIC8	Cushion Clamps	1-⅝"	pk 10
GMIC9	Cushion Clamps	1-¾"	pk 10

Aluminium Channel



- Recommended for mounting all sizes of Cushion Clamps

Part No	Description	Size
GMIC15	Aluminium Channel	41mm x 21mm x 3mt



QPC Clips



- Easy installation - twists into 41mm channel
- External diameter matches diameter of pipes with 9mm insulation
- Clip is constructed to insulate pipe and withstand temperatures between -30°C & 135°C
- Excellent resistance to oil
- Helps dampen noise and vibrations

Part No	Description	Size	Qty/Pk
GMQP1	QPC Clips	¼"	pk 10
GMQP2	QPC Clips	⅜"	pk 10
GMQP3	QPC Clips	½"	pk 10
GMQP4	QPC Clips	⅝"	pk 10
GMQP5	QPC Clips	¾"	pk 10
GMQP6	QPC Clips	⅞"	pk 10
GMQP7	QPC Clips	1-¼"	pk 10
GMQP8	QPC Clips	1-⅜"	pk 10
GMQP9	QPC Clips	1-½"	pk 10



Channel Clips

GMIC26
 Channel Clip
 32mm

GMIC27
 Channel Clip
 35mm

GMIC28
 Channel Clip
 40mm

GMIC29
 Channel Clip
 42mm

- Suitable for ½" copper with 9mm wall lagging or ¾" copper with 13mm wall lagging
- Suitable for ⅝" & ¾" copper with 9mm wall lagging or ⅞" & 1" copper with 13mm wall lagging
- Also suitable for 1-¼" plastic waste pipe
- Suitable for ¾" copper with 9mm wall lagging or 1" copper with 13mm wall lagging
- Suitable for 1-¼" copper with 9mm wall lagging or 1-½" copper with 13mm wall lagging

Part No	Description	Size	Qty/Pk
GMIC26	Channel Clips	32mm	pk 10
GMIC27	Channel Clips	35mm	pk 10
GMIC28	Channel Clips	40mm	pk 10
GMIC29	Channel Clips	42mm	pk 10

- Designed for rapid single handed installation
- Fits 41mm channel
- Quick to fit over insulated pipes
- Twists into channel



Black Twist Channel Tie Bases

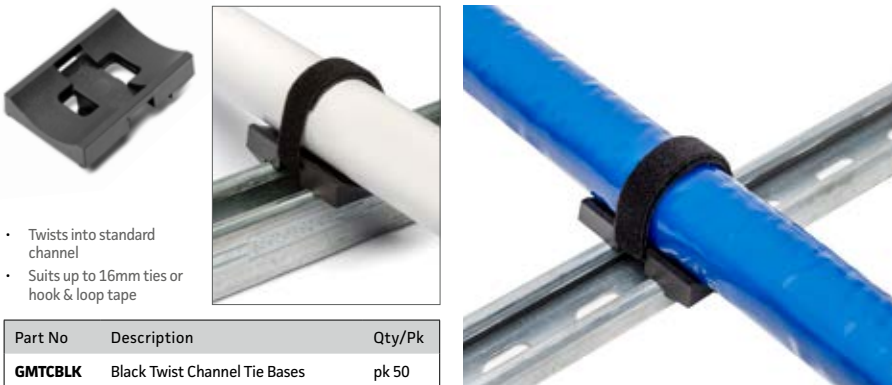

- Twists into standard channel
- Suits up to 16mm ties or hook & loop tape

Part No	Description	Qty/Pk
GMTCLBK	Black Twist Channel Tie Bases	pk 50

Black Twist Tie Bases for M10 Studding

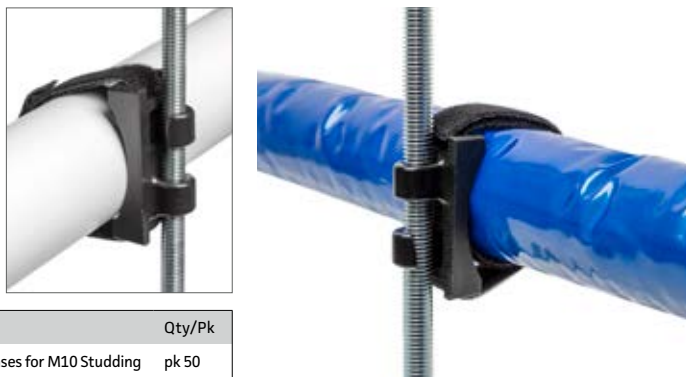

- Twists onto M10 studding
- Suits up to 16mm ties or hook & loop tape

Part No	Description	Qty/Pk
GMTSB	Black Twist Tie Bases for M10 Studding	pk 50

Black Hook & Loop Tape (Velcro)

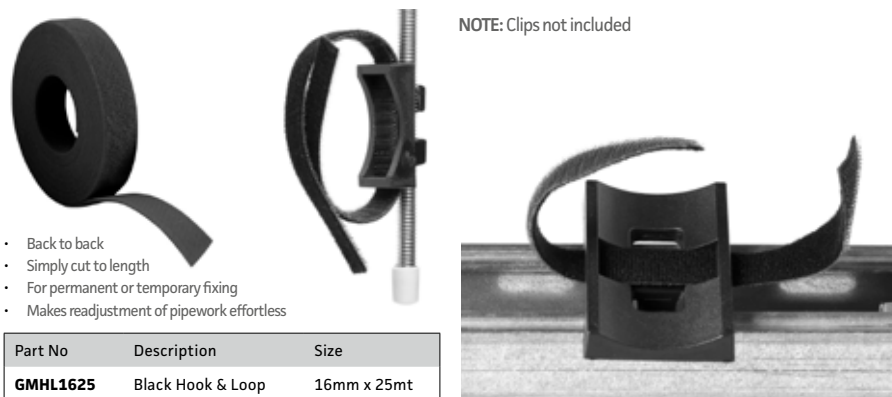

- Back to back
- Simply cut to length
- For permanent or temporary fixing
- Makes readjustment of pipework effortless

Part No	Description	Size
GMHL1625	Black Hook & Loop	16mm x 25mt

Stud Clips for 3/4" Overflow Pipe



M8 & M10

- Fast fixing direct to studding
- Simple to install, adjust and relocate
- Fits metric and imperial pipe sizes

Part No	Description	Colour	Size	Qty/Pk
GMRP4	M8 Stud Clips	Black	22mm (3/4")	pk 10
GMRP16	M10 Stud Clips	Black	22mm (3/4")	pk 10

Open Stud Clips for 3/4" Overflow Pipe



M8 Only

- Twin application pipe clips enable your pipe to be either fixed to threaded rod or surface mounted
- Simply snap onto threaded rod & adjust up or down
- Features a screw hole in the back to allow surface mounting

Part No	Description	Colour	Size	Qty/Pk
GMRP34	Open Stud Clips	Black	22mm (3/4")	pk 10
GMRP4W	Open Stud Clips	White	22mm (3/4")	pk 10

Stud Clips for 1-3/4" & 1-1/2" Waste Pipe



M8 & M10

- Fast fixing direct to studding
- Simple to install, adjust and relocate
- Fits metric and imperial pipe sizes

Part No	Description	Colour	Size	Qty/Pk
GMRP8	M8 Stud Clip	Black	35mm (1-3/4")	pk 10
GMRP20	M10 Stud Clip	Black	35mm (1-3/4")	pk 10
GMRP10	M8 Stud Clip	Black	42mm (1-1/2")	pk 10
GMRP22	M10 Stud Clip	Black	42mm (1-1/2")	pk 10

Open Stud Clips for 1-3/4" Waste Pipe



M8 Only

- Twin application pipe clips enable your pipe to be either fixed to threaded rod or surface mounted
- Simply snap onto threaded rod & adjust up or down
- Features a screw hole in the back to allow surface mounting

Part No	Description	Colour	Size	Qty/Pk
GMRP38	Open Stud Clips	Black	35mm (1-3/4")	pk 10
GMRP8W	Open Stud Clips	White	35mm (1-3/4")	pk 10

Stud Clips



- Fast fixing direct to studding
- Simple to install, adjust and relocate
- Fits metric and imperial pipe sizes

Part No	Description	Colour	Metric	Imperial	Stud Size	Qty/Pk	Suited For
GMRP2	Stud Pipe Clips	Black	15mm	5/8"	M8	pk 10	
GMRP4	Stud Pipe Clips	Black	22mm	7/8"	M8	pk 10	3/4" Overflow Pipe
GMRP5	Stud Pipe Clips	Black	25mm	1"	M8	pk 10	
GMRP6	Stud Pipe Clips	Black	28mm	1-1/8"	M8	pk 10	
GMRP7	Stud Pipe Clips	Black	32mm	1-1/4"	M8	pk 10	
GMRP8	Stud Pipe Clips	Black	35mm	1-3/8"	M8	pk 10	1-1/4" Waste Pipe
GMRP9	Stud Pipe Clips	Black	40mm	1-1/2"	M8	pk 10	
GMRP10	Stud Pipe Clips	Black	42mm	1-5/8"	M8	pk 10	1-1/2" Waste Pipe
GMRP11	Stud Pipe Clips	Black	50mm	2"	M8	pk 10	
GMRP12	Stud Pipe Clips	Black	54mm	2-1/8"	M8	pk 10	2" Waste Pipe
GMRP14	Stud Pipe Clips	Black	15mm	5/8"	M10	pk 10	
GMRP16	Stud Pipe Clips	Black	22mm	7/8"	M10	pk 10	3/4" Overflow Pipe
GMRP18	Stud Pipe Clips	Black	28mm	1-1/8"	M10	pk 10	
GMRP19	Stud Pipe Clips	Black	32mm	1-1/4"	M10	pk 10	
GMRP20	Stud Pipe Clips	Black	35mm	1-3/8"	M10	pk 10	1-1/4" Waste Pipe
GMRP21	Stud Pipe Clips	Black	40mm	1-1/2"	M10	pk 10	
GMRP22	Stud Pipe Clips	Black	42mm	1-5/8"	M10	pk 10	1-1/2" Waste Pipe
GMRP24	Stud Pipe Clips	Black	54mm	2-1/8"	M10	pk 10	2" Waste Pipe

Clip Selection Guide

Copper with 9mm wall lagging

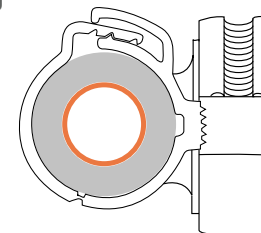

Clip Size	Copper + 9mm Wall Lagging	M8 Stud Clip Part No's	M10 Stud Clip Part No's
25mm	3/4"	GMRP5	
28mm	3/4"	GMRP6	GMRP18
32mm	1/2"	GMRP7	GMRP19
35mm	5/8" & 3/4"	GMRP8	GMRP20
40mm	3/4"	GMRP9	GMRP21
42mm	1 1/8"	GMRP10	GMRP22
54mm	1 3/8"	GMRP12	GMRP24

Plastic Drain

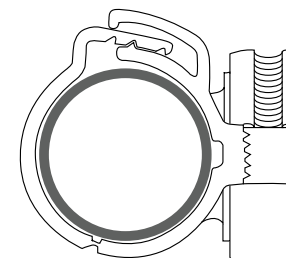

Clip Size	Plastic Drain	M8 Stud Clip Part No's	M10 Stud Clip Part No's
22mm	3/4" Overflow	GMRP4, GMRP4W & GMRP34	GMRP16
35mm	1 1/4" Waste	GMRP8, GMRP8W & GMRP38	GMRP20
42mm	1 1/2" Waste	GMRP10	GMRP22
54mm	2" Waste	GMRP12	GMRP24

Copper with 13mm wall lagging

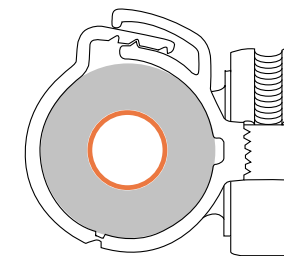

Clip Size	Copper + 13mm Wall Lagging	M8 Stud Clip Part No's	M10 Stud Clip Part No's
32mm	3/4"	GMRP7	GMRP19
35mm	5/8" & 3/4"	GMRP8	GMRP20
40mm	3/4"	GMRP9	GMRP21
42mm	3/4"	GMRP10	GMRP22
50mm	7/8"	GMRP11	
54mm	1 1/8"	GMRP12	GMRP24

Plumbing & Refrigeration Copper without lagging

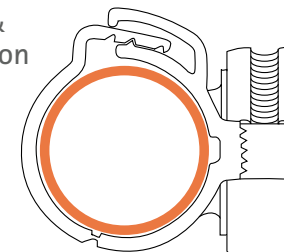

Clip Size	Plumbing Copper	Refrigeration Copper	M8 Stud Clip Part No's	M10 Stud Clip Part No's
15mm	15mm		GMRP2	
22mm	22mm	7/8"	GMRP4, GMRP4W & GMRP34	GMRP16
25mm		1"	GMRP5	
28mm	28mm	1 1/8"	GMRP6	GMRP18
32mm		1 1/4"	GMRP7	GMRP19
35mm	35mm	1 3/8"	GMRP8, GMRP8W & GMRP38	GMRP20
40mm		1 1/2"	GMRP9	GMRP21
42mm	42mm	1 5/8"	GMRP10	GMRP22
50mm		2"	GMRP11	
54mm	54mm	2 1/8"	GMRP12	GMRP24

Metal Suspender Clips



- The quick and effective way of suspending pipework from M8 and M10 studding
- By simply squeezing the tips together the spring steel rod hanger can be fitted or adjusted in seconds



Part No	Description	Size	Qty/Pk
GMSC1	Size 1 Suspender Clips	For ¼" & ½"	pk 10
GMSC2	Size 2 Suspender Clips	For ¾" & ¾"	pk 10
GMSC3	Size 3 Suspender Clips	For ½" & ¾"	pk 10
GMSC4	Size 4 Suspender Clips	For ¾" & 1-½"	pk 10

Plastic Suspender Clips

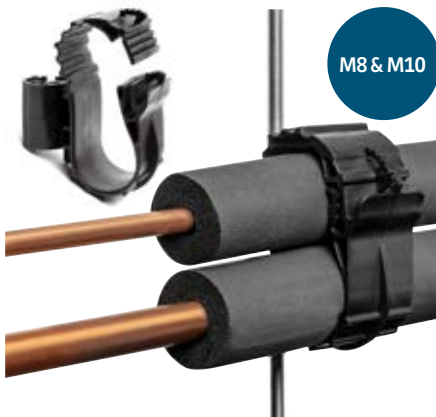

M8 & M10



M8 Only

- Ideal for supporting pipework hanging from ceilings
- Fits securely to both M8 and M10 studding
- Adjustable clipping mechanism

- Offers horizontal support for pipe sets on air conditioning systems
- For M8 studding
- Simple to install, adjust and relocate
- Secure extendible ratchet closure
- Clip encloses both line set and cables
- Max recommended distance per clip 1.2m

Part No	Description	Size	Qty/Pk
GMSCP2	Plastic Suspender Clips	For ¾" & ¾"	pk 5
GMSCP3	Plastic Suspender Clips	For ½" & ¾"	pk 5
GMSCP4	Plastic Suspender Clips	For ¾" & 1-½"	pk 5

Part No	Description	Size	Qty/Pk
GMRP50	Plastic Suspender Clips	½" - ¾" to ¾" - 1-½"	pk 5

Grip Locks



Part No	Description	Size	Range	Qty/Pk
GMG1	No 1 Grip Locks	54mm	For ¼" & ½"	pk 10
GMG2	No 2 Grip Locks	60mm	For ¾" & ¾"	pk 10
GMG3	No 3 Grip Locks	67mm	For ½" & ¾"	pk 10
GMG4	No 4 Grip Locks	80mm	For ¾" & 1-½"	pk 10

- For internal & external use
- Coated with yellow passivate
- Hinged for easy pipe installation
- Wide metal components for good pipe support
- Space for electrical cables and condensate tube
- Fits directly to walls or ceilings

Black Grip Fit Clamps



Part No	Description	Size	Qty/Pk
GMGFC1	No 1 Grip Fit Clamps	For ¼" & ½"	pk 10
GMGFC2	No 2 Grip Fit Clamps	For ¾" & ¾"	pk 10
GMGFC3	No 3 Grip Fit Clamps	For ½" & ¾"	pk 10
GMGFC4	No 4 Grip Fit Clamps	For ¾" & 1-½"	pk 10

- The asymmetric design provides a perfect fit for any one of four pairs of flow and return insulated refrigerant pipes
- 8mm clearance hole allows the clamp to be fixed directly to any flat surface, such as a wall or ceiling.
- Corrosion-resistant black zinc coating to match pipe insulation
- Mounts to any flat surface, in any orientation
- Hinged design allows for a quick install

3 Pipe Stud Clips



Part No	Description	Size	Qty/Pk
GMJ70	3 Pipe Clip	¾", ¾" & ¾" to ¾", ¾" & 1"	pk 5
GMJ71	3 Pipe Clip	½", 1 ¼", ¾" to ¾", 1", 1 ¼"	pk 5
GMJ72	3 Pipe Clip	¾", 1 ¼", 1 ¼" to ¾", 1 ¾", 1 ¾"	pk 5
GMJ73	3 Pipe Clip	¾", 1 ¼", 1 ¼" to ¾", 1 ¾", 1 ¾"	pk 5

- Ideal for the suspension of VRV/VRF pipe runs
- Locates onto M8 and M10 studding
- No need for cable tray
- Hinge security cover plate fastens with one screw
- Can be used for surface mount
- Note: Approximate pipe sizes (allowing for 13mm insulation)

Rubber Lined Pipe Clamps



- All clips are dual tapped to take M8 and M10 studding
- Rubber lining ideal for both insulation and noise control
- *GMJ4 suits 1-¼" drain

Part No	Description	Size	Qty/Pk
GMJ1-50	Rubber Lined Pipe Clamp	15mm	pk 50
GMJ2-50	Rubber Lined Pipe Clamp	22mm	pk 50
GMJ3-50	Rubber Lined Pipe Clamp	28mm	pk 50
GMJ4-50*	Rubber Lined Pipe Clamp	35mm	pk 50

Part No	Description	Size	Qty/Pk
GMJ5-50	Rubber Lined Pipe Clamp	42mm	pk 50
GMJ13B-50	Rubber Lined Pipe Clamp	48 - 53mm	pk 50
GMJ6-50	Rubber Lined Pipe Clamp	54mm	pk 50
GMJ14B	Rubber Lined Pipe Clamp	58 - 64mm	Each
GMJ11B	Rubber Lined Pipe Clamp	108mm	Each

Brass Pipe Rings



Part No	Description	Size	Qty/Pk
GMJ14A	M10 Single Brass Pipe Ring	15mm	Each
GMJ15	M10 Single Brass Pipe Ring	22mm	Each
GMJ16	M10 Single Brass Pipe Ring	28mm	Each
GMJ17	M10 Single Brass Pipe Ring	35mm	Each
GMJ18	M10 Single Brass Pipe Ring	42mm	Each

- Used for pipe installation/management
- Can be used in conjunction with M10 male backplates
- Available to suit common pipe sizes, from 15mm up to 42mm

Brass Backplates



- Can be used in conjunction with M10 studding
- Can be used in conjunction with brass pipe rings to secure copper pipework to walls and ceilings
- Available in M10

Part No	Description	Size	Qty/Pk
GMJ13A	Male Brass Backplate	M10	Each
GMJ11A	Female Brass Backplate	M10	Each

Pressed Pipe Clips



- Used for pipe installation/management
- Available to suit common pipe sizes, from 15mm up to 28mm

Part No	Description	Size	Qty/Pk
GMPC30	Pressed Pipe Clip	15mm	Each
GMPC31	Pressed Pipe Clip	22mm	Each
GMPC32	Pressed Pipe Clip	28mm	Each

Munson Bases

STÖRNCH



- Used to attach studding to a flat surface
- Dual tapped to accept M8 or M10 threads
- Zinc plated (BZP)

Part No	Description	Qty/Pk
GMJ12A-25	Dual Tapped Munson Bases BZP	pk 25

Talon Pipe Clips

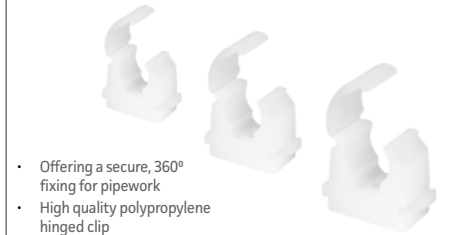

- Offering a secure, 360° fixing for pipework
- High quality polypropylene hinged clip

Part No	Description	Size	Qty/Pk
GMTAL15S	Talon Pipe Clips	15mm	pk 100
GMTAL22S	Talon Pipe Clips	22mm	pk 100
GMTAL28S	Talon Pipe Clips	28mm	pk 50

Copper & Lagging, Brazing & Gas

Contents

Refrigeration Copper	69
Refrigeration Copper & Pipe Straighteners	70
Pre-Lagged Copper Pair Coils	71
Refrigeration Copper Fittings	72 - 77
Armaflex Class '0' Lagging - Straight Lengths	78
Armaflex Class '0' Lagging - Bagged Coils	79
Armaflex Class '0' Lagging - Boxed Coils	80
Armaflex Ultima Lagging	81
Lagging Accessories	82
Sheet Insulation, Cable Ties & Tie Bases	83
Brazing Rods	84
Brazing Gas	85
Gas - Refrigerants	86
Gas - Nitrogen & Reclaim Cylinders	87

Refrigeration Copper Straight Lengths

Part No	Description	OD	Gauge	Length
GMCU12	Half Hard Copper	3/8"	21g	3mt
GMCU12L	Half Hard Copper	3/8"	21g	6mt
GMCU13	Half Hard Copper	1/2"	20g	3mt
GMCU13L	Half Hard Copper	1/2"	20g	6mt
GMCU14	Half Hard Copper	5/8"	20g	3mt
GMCU14L	Half Hard Copper	5/8"	20g	6mt
GMCU15	Half Hard Copper	3/4"	19g	3mt
GMCU15L	Half Hard Copper	3/4"	19g	6mt
GMCU16	Half Hard Copper	7/8"	18g	3mt
GMCU16L	Half Hard Copper	7/8"	18g	6mt
GMCU17	Half Hard Copper	1-1/8"	18g	3mt
GMCU17F	Half Hard Copper	1-1/8"	16g	3mt
GMCU17L	Half Hard Copper	1-1/8"	18g	6mt
GMCU17FL	Half Hard Copper	1-1/8"	16g	6mt
GMCU18	Half Hard Copper	1-3/8"	18g	3mt
GMCU18F	Half Hard Copper	1-3/8"	16g	3mt
GMCU18L	Half Hard Copper	1-3/8"	18g	6mt
GMCU18FL	Half Hard Copper	1-3/8"	16g	6mt
GMCU19	Half Hard Copper	1-5/8"	18g	3mt
GMCU19F	Half Hard Copper	1-5/8"	16g	3mt
GMCU19L	Half Hard Copper	1-5/8"	18g	6mt

3mt
&
6mt



• All copper conforms to PED and relevant EN British standards - EN12735-1 R220.

6 Metre Own Van Deliveries

- Large stocks of 6mt copper, available for next day delivery to site or stores on our own transport
- Due to some unique modifications to our delivery vehicles, we can ensure your stock will arrive dry and in pristine condition, every time!



Refrigeration Copper Coils

- All copper conforms to PED and relevant EN British standards - EN12735-1 R220.

Part No	Description	OD	Gauge	Length
GMCU6	Soft Copper Coil	¾"	22g	15mt
GMCU1	Soft Copper Coil	¾"	22g	30mt
GMCU7	Soft Copper Coil	¾"	21g	15mt
GMCU2	Soft Copper Coil	¾"	21g	30mt
GMCU8	Soft Copper Coil	½"	21g	15mt
GMCU3	Soft Copper Coil	½"	21g	30mt
GMCU9	Soft Copper Coil	¾"	20g	15mt
GMCU4	Soft Copper Coil	¾"	20g	30mt
GMCU10	Soft Copper Coil	¾"	19g	15mt
GMCU5	Soft Copper Coil	¾"	19g	30mt
GMCU11	Soft Copper Coil	¾"	19g	15mt
GMCU26	Soft Copper Coil	¾"	19g	30mt



Soft Copper Coil Pipe Straighteners



- For straightening copper tube
- Efficient, hand held tool
- Fast, simple, straight alignment of copper coils

Part No	Description	Size
GMP514	Pipe Straightener	¾"
GMP538	Pipe Straightener	¾"
GMP512	Pipe Straightener	¾"

Pipework Identification Labels



- Add the perfect finishing touch to every install. Simply peel off and wrap-around your lagged pipes to clearly mark up each BC Box connection
- Printed on a durable material, simply write on the refrigerant type, location of the fan coil or other I.D. information
- Printed 'System No's 1-16'

Part No	Description	Qty/Pk
GMPID	Pipework Identification Labels	pk 16

Pre-Lagged Copper Pair Coils



Part No	Description	Pipe Sizes	Wall Size
GMLPC1438C09	20mt Pair Coil	¼" & ⅜"	9mm
GMLPC1438C013	20mt Pair Coil	¼" & ⅜"	13mm

Pre-Lagged Copper Pair Coils



Part No	Description	Pipe Sizes	Wall Size
GMLPC1412C09	20mt Pair Coil	¼" & ½"	9mm
GMLPC1412C013	20mt Pair Coil	¼" & ½"	13mm

Pre-Lagged Copper Pair Coils



Part No	Description	Pipe Sizes	Wall Size
GMLPC1458C09	20mt Pair Coil	¼" & ⅝"	9mm
GMLPC1458C013	20mt Pair Coil	¼" & ⅝"	13mm

Pre-Lagged Copper Pair Coils



Part No	Description	Pipe Sizes	Wall Size
GMLPC3858C09	20mt Pair Coil	⅜" & ⅝"	9mm
GMLPC3858C013	20mt Pair Coil	⅜" & ⅝"	13mm

- Backed by Lawton's reputation for quality, service and customer care for over 100 years
- Meets UK Building and Fire Safety Regulations
- Class O tested and passed in the UK for complete peace of mind
- Nitrile Butadiene Rubber (NBR) Class O rated insulation matched with Lawton Copper tube gives total product confidence
- Suitable for Air Conditioning and Refrigeration applications
- Easy installation. No glue, tape or messy powder
- Using pre insulated coils achieves pipework installation in less time than conventional methods
- Unique profile developed for easy splitting during installation

LAWTON TUBES

Straight Connectors



- End feed/end brazed fittings
- Supplied degreased

Part No	Description	Size
GMCF0	Straight Connector	¼"
GMCF1	Straight Connector	⅜"
GMCF2	Straight Connector	½"
GMCF3	Straight Connector	⅝"
GMCF4	Straight Connector	¾"
GMCF5	Straight Connector	⅞"
GMCF6	Straight Connector	1-⅜"
GMCF7	Straight Connector	1-½"
GMCF8	Straight Connector	1-⅝"

Equal Tees

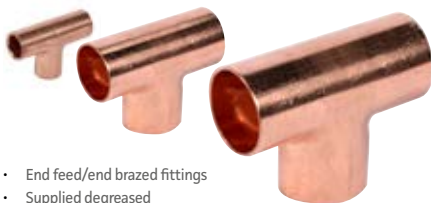

- End feed/end brazed fittings
- Supplied degreased

Part No	Description	Size
GMCF29	Equal Tee	¼"
GMCF30	Equal Tee	⅜"
GMCF31	Equal Tee	½"
GMCF32	Equal Tee	⅝"
GMCF33	Equal Tee	¾"
GMCF34	Equal Tee	⅞"
GMCF35	Equal Tee	1-⅜"
GMCF36	Equal Tee	1-½"
GMCF37	Equal Tee	1-⅝"

45° Bends C - C



- End feed/end brazed fittings
- Supplied degreased
- Copper tube to copper tube

Part No	Description	Size
GMCF20	45° Bend C-C	⅜"
GMCF21	45° Bend C-C	½"
GMCF22	45° Bend C-C	⅝"
GMCF23	45° Bend C-C	¾"
GMCF24	45° Bend C-C	⅞"
GMCF25	45° Bend C-C	1-⅜"
GMCF26	45° Bend C-C	1-½"
GMCF27	45° Bend C-C	1-⅝"

End Caps



- End feed/end brazed fittings
- Supplied degreased
- Used for capping off copper tube

Part No	Description	Size
GMCF76	End Cap	⅜"
GMCF60	End Cap	½"
GMCF61	End Cap	⅝"
GMCF62	End Cap	¾"
GMCF63	End Cap	⅞"
GMCF64	End Cap	1-⅜"
GMCF65	End Cap	1-½"
GMCF66	End Cap	1-⅝"

90° Long Radius Elbows C - C



- End feed/end brazed fittings
- Supplied degreased
- Copper tube to copper tube

Part No	Description	Size
GMCF9	90° Long Radius Elbow C-C	¼"
GMCF10	90° Long Radius Elbow C-C	⅜"
GMCF11	90° Long Radius Elbow C-C	½"
GMCF12	90° Long Radius Elbow C-C	⅝"
GMCF13	90° Long Radius Elbow C-C	¾"
GMCF14	90° Long Radius Elbow C-C	⅞"
GMCF15	90° Long Radius Elbow C-C	1-⅜"
GMCF16	90° Long Radius Elbow C-C	1-½"
GMCF17	90° Long Radius Elbow C-C	1-⅝"

90° Long Radius Street Elbows F - C



- End feed/end brazed fittings
- Supplied degreased
- Copper fitting to copper tube

Part No	Description	Size
GMCF144	90° Long Radius Street Elbow F-C	1-⅜"
GMCF145	90° Long Radius Street Elbow F-C	1-½"
GMCF146	90° Long Radius Street Elbow F-C	1-⅝"

90° Short Radius Elbows C-C



- End feed/end brazed fitting
- Supplied degreased
- Copper tube to copper tube

Part No	Description	Size
GMCF296	90° Short Radius Elbow C-C	1 ⅜"
GMCF297	90° Short Radius Elbow C-C	1 ½"
GMCF298	90° Short Radius Elbow C-C	1 ⅝"

Reducing Couplings C - C



- End feed/end brazed fittings
- Supplied degreased
- Copper tube to copper tube

Part No	Description	Tube OD
GMCF40	Reducing Coupling C-C	⅜" - ¼"
GMCF41	Reducing Coupling C-C	½" - ⅜"
GMCF239	Reducing Coupling C-C	⅝" - ⅜"
GMCF42	Reducing Coupling C-C	¾" - ⅝"
GMCF241	Reducing Coupling C-C	⅞" - ⅝"
GMCF43	Reducing Coupling C-C	¾" - ⅝"
GMCF242	Reducing Coupling C-C	⅞" - ⅝"
GMCF243	Reducing Coupling C-C	⅞" - ⅝"
GMCF244	Reducing Coupling C-C	⅞" - ⅝"
GMCF44	Reducing Coupling C-C	⅞" - ¾"
GMCF246	Reducing Coupling C-C	1-⅜" - ⅝"
GMCF247	Reducing Coupling C-C	1-⅜" - ¾"
GMCF45	Reducing Coupling C-C	1-⅜" - ⅞"
GMCF249	Reducing Coupling C-C	1-⅜" - ¾"
GMCF250	Reducing Coupling C-C	1-⅜" - ⅞"
GMCF46	Reducing Coupling C-C	1-⅜" - 1-⅝"
GMCF252	Reducing Coupling C-C	1-⅜" - ⅞"
GMCF253	Reducing Coupling C-C	1-⅜" - 1-⅝"
GMCF47	Reducing Coupling C-C	1-⅜" - 1-⅝"

Fitting Reducers F - C



- End feed/end brazed fittings
- Supplied degreased
- Copper fitting to copper tube

Part No	Description	Tube OD
GMCF188	Fitting Reducer F-C	⅜" - ¼"
GMCF189	Fitting Reducer F-C	½" - ⅜"
GMCF190	Fitting Reducer F-C	½" - ⅜"
GMCF191	Fitting Reducer F-C	⅝" - ⅜"
GMCF192	Fitting Reducer F-C	⅝" - ½"
GMCF193	Fitting Reducer F-C	¾" - ⅝"
GMCF194	Fitting Reducer F-C	¾" - ⅝"
GMCF195	Fitting Reducer F-C	¾" - ⅝"
GMCF196	Fitting Reducer F-C	⅞" - ⅝"
GMCF197	Fitting Reducer F-C	⅞" - ½"
GMCF198	Fitting Reducer F-C	⅞" - ⅝"
GMCF199	Fitting Reducer F-C	⅞" - ¾"
GMCF201	Fitting Reducer F-C	1-⅜" - ⅝"
GMCF202	Fitting Reducer F-C	1-⅜" - ¾"
GMCF203	Fitting Reducer F-C	1-⅜" - ⅞"
GMCF204	Fitting Reducer F-C	1-⅜" - ⅝"
GMCF205	Fitting Reducer F-C	1-⅜" - ¾"
GMCF206	Fitting Reducer F-C	1-⅜" - ⅞"
GMCF207	Fitting Reducer F-C	1-⅜" - 1-⅝"
GMCF208	Fitting Reducer F-C	1-⅜" - ¾"
GMCF209	Fitting Reducer F-C	1-⅜" - ⅞"
GMCF210	Fitting Reducer F-C	1-⅜" - 1-⅝"

Flare Nuts



- Manufactured from brass
- Used for making flare connections

Part No	Description	Size
GMCF50	Short Flare Nut	¼"
GMCF51	Short Flare Nut	¾"
GMCF52	Short Flare Nut	½"
GMCF53	Short Flare Nut	¾"
GMCF54	Short Flare Nut	¾"
GMFN03	Flare Nut Oil	118ml

Line Tap Valve

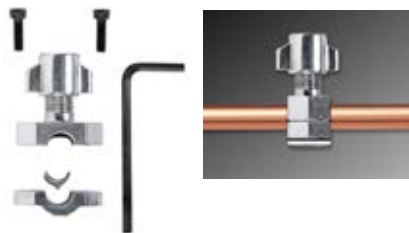

- The quick, safe & easy option to change, discharge & test a line
- The line tap valve is a quick & effective tool for piercing ¼" & ¾" tube & pipework

Part No	Description	Size Range
GM4338	Line Tap Valve	¼" & ¾"

Charging Stub



- c/w ¼" copper tail
- c/w Schrader valve

Part No	Description	Size	Qty/Pk
GMSU04-10	Charging Stub	¼" MFL	pk 10

Flare Unions



- Manufactured from brass
- Used when making flare connections

Part No	Description	Size
GMCF55	Male Flare Union	¼"
GMCF56	Male Flare Union	¾"
GMCF57	Male Flare Union	½"
GMCF58	Male Flare Union	¾"
GMCF59	Male Flare Union	¾"

Valve Core Remover/Installer



- Sturdy ball valve design controls refrigerant flow with 1/4 turn of the valve lever.
- Lever position also gives visual indication of whether valve is opened or closed
- ¾" service port

Part No	Description	Qty/Pk
GM3930	Valve Core Remover	Each

Charging Stub for R410a

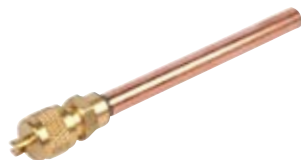

- Compatible with R410a or R32
- c/w ¼" copper tail
- c/w Schrader valve

Part No	Description	Size	Qty/Pk
GMSU05	Charging Stub	¼" MFL	Each

P Traps



- Degreased copper end feed/end brazed
- Manufactured to ASME B16.22-2001

Part No	Description	Size
GMCF110	Copper P Trap	¾"
GMCF111	Copper P Trap	¾"
GMCF112	Copper P Trap	¾"
GMCF113	Copper P Trap	1-¾"

P Traps - Also Compatible with Pressfit

- These P Traps have plain copper tails that can be crimped directly onto, making them pressfit compatible

Part No	Description	Size	Qty/Pk
GMZL911	Pressfit P traps	½"	Each
GMZL912	Pressfit P traps	¾"	Each
GMZL913	Pressfit P traps	¾"	Each
GMZL914	Pressfit P traps	¾"	Each
GMZL915	Pressfit P traps	1¾"	Each
GMZL916	Pressfit P traps	1¾"	Each



Y Joints - Also Compatible with Pressfit

- These Y Joints have plain copper tails which makes them pressfit compatible

Part No	Description	Size	Qty/Pk
GMZL917	Pressfit Y Joints	¾"	Each
GMZL918	Pressfit Y Joints	¾"	Each
GMZL919	Pressfit Y Joints	¾"	Each
GMZL920	Pressfit Y Joints	¾"	Each
GMZL921	Pressfit Y Joints	¾"	Each
GMZL922	Pressfit Y Joints	1¾"	Each
GMZL923	Pressfit Y Joints	1¾"	Each



Ball Valves c/w Access Ports

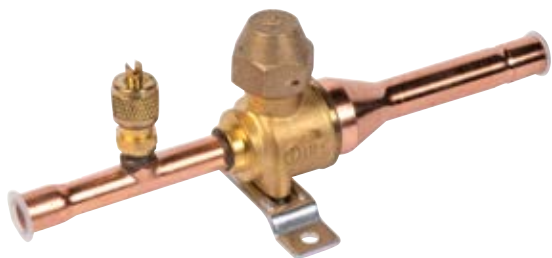

- c/w access port Schrader valve
- Quick turn knob
- End feed/end brazed fittings
- Supplied degreased

Part No	Description	Size
GMCF118	Ball Valve c/w Access Port	3/8"
GMCF119	Ball Valve c/w Access Port	1/2"
GMCF120	Ball Valve c/w Access Port	3/4"

Part No	Description	Size
GMCF121	Ball Valve c/w Access Port	3/4"
GMCF122	Ball Valve c/w Access Port	7/8"
GMCF123	Ball Valve c/w Access Port	1-3/8"

Ball Valves c/w Schrader - Also Compatible with Pressfits



- Ball Valves with Schraders are part of our range of ancillary products for press fitting. These have plain copper tails which makes them press fit compatible

Part No	Description	Size	Qty/Pk
GMZL924	Pressfit Ball Valve	3/4"	Each
GMZL925	Pressfit Ball Valve	3/4"	Each
GMZL926	Pressfit Ball Valve	1/2"	Each
GMZL927	Pressfit Ball Valve	3/8"	Each

Part No	Description	Size	Qty/Pk
GMZL928	Pressfit Ball Valve	3/4"	Each
GMZL929	Pressfit Ball Valve	7/8"	Each
GMZL930	Pressfit Ball Valve	1 1/8"	Each
GMZL931	Pressfit Ball Valve	1 3/8"	Each

Liquid Line Sight Glasses



- Designed to determine the moisture content of a system's refrigerant.
- Has a unique high accuracy moisture indicator for CFC, HCFC, and HFC refrigerants.
- End feed/end brazed fittings
- Supplied degreased
- Single indicator for all common refrigerants

Part No	Description	Size
GM3MF	Liquid Line Sight Glass	3/8"
GM4MF	Liquid Line Sight Glass	1/2"

Liquid Line Sight Glass - Flare



- Designed to determine the moisture content of a system's refrigerant
- Has a unique high accuracy moisture indicator for CFC, HCFC, and HFC refrigerants.
- Supplied with 3/8" SAE male flare thread connections
- Supplied degreased
- Single indicator for all common refrigerants

Part No	Description	Size
GMSG38F	Liquid Line Sight Glass - Flare	3/8"

Liquid Line Filter Driers



- Designed for general protection and cleaning of refrigeration systems
- For use with HCFC's, CFC's and the lubricants that go with them
- High moisture, acids and dirt removal capacity
- With male thread flare connections

Part No	Description	Size
GM052F	Liquid Line Drier - Flare	3/4"
GM083F	Liquid Line Drier - Flare	3/8"
GM164F	Liquid Line Drier - Flare	1/2"
GM415F	Liquid Line Drier - Flare	3/8"

Liquid Line Filter Driers - Also Compatible with Pressfit



- These have plain copper tails that can be crimped directly onto, making them pressfit compatible

Part No	Description	Size	Qty/Pk
GMZL909	Liquid Line Filter Drier	3/8"	Each
GMZL910	Liquid Line Filter Drier	1/2"	Each

2mt Lengths Class 'O' Lagging 3/8" Wall



3/8" (9mm) Wall

- Comes in short, manageable 2mt lengths
- Perfect for lagging straight lengths of copper
- Box quantity varies according to insulation size

Part No	Description	Pipe Size	Wall Size	Lengths/Box
GMEU13	2mt Straights	1/4"(6mm)	3/8"	176
GMEU14	2mt Straights	3/8"(10mm)	3/8"	140
GMEU15	2mt Straights	1/2"(12mm)	3/8"	120
GMEU16	2mt Straights	3/4"(15mm)	3/8"	96
GMEU17	2mt Straights	1"(20mm)	3/8"	78
GMEU41	2mt Straights	1-1/8"(22mm)	3/8"	70
GMEU42	2mt Straights	1-3/8"(28mm)	3/8"	49
GMEU43	2mt Straights	1-3/4"(35mm)	3/8"	42
GMEU44	2mt Straights	1-3/4"(42mm)	3/8"	30

2mt Lengths Class 'O' Lagging 1/2" Wall



1/2" (13mm) Wall

Part No	Description	Pipe Size	Wall Size	Lengths/Box
GMEU18	2mt Straights	1/4"(6mm)	1/2"	113
GMEU19	2mt Straights	3/8"(10mm)	1/2"	94
GMEU20	2mt Straights	1/2"(12mm)	1/2"	81
GMEU21	2mt Straights	3/4"(15mm)	1/2"	68
GMEU22	2mt Straights	1"(20mm)	1/2"	56
GMEU23	2mt Straights	1-1/8"(22mm)	1/2"	52
GMEU24	2mt Straights	1-3/8"(28mm)	1/2"	39
GMEU25	2mt Straights	1-3/4"(35mm)	1/2"	30
GMEU26	2mt Straights	1-3/4"(42mm)	1/2"	28

2mt Lengths Class 'O' Lagging 3/4" Wall



3/4" (19mm) Wall



Part No	Description	Pipe Size	Wall Size	Lengths/Box
GMEU70	2mt Straights	3/8"(10mm)	3/4"	52
GMEU71	2mt Straights	1/2"(12mm)	3/4"	46
GMEU72	2mt Straights	3/4"(15mm)	3/4"	39
GMEU73	2mt Straights	1"(20mm)	3/4"	35
GMEU74	2mt Straights	1-1/8"(22mm)	3/4"	32
GMEU75	2mt Straights	1-3/8"(28mm)	3/4"	25
GMEU76	2mt Straights	1-3/4"(35mm)	3/4"	20
GMEU77	2mt Straights	1-3/4"(42mm)	3/4"	16

Armaflex Class 'O' Insulation

- Including - 2mt Lengths, 15mt Bagged Coils & Boxed Coils
- Built-in anti-microbial protection inhibits the growth of mould and bacteria
- Offers an effective additional line of defence against the growth of microbes
- Anti-microbial agents provide protection for the life of the insulation
- Built-in vapour barrier prevents condensation
- Reduce energy losses up to 87%
- Excellent resistance to the effects of ozone, oil and chemicals

Class 'O' Insulation for Barrier Pipe



- For 25mm Barrier Pipe

Part No	Description	Pipe Size	Wall Size	Lengths/Box
GMEUH1325	2mt Straights	25mm	1/2"	42

Bagged Coils Class 'O' Lagging 3/8" Wall



3/8" (9mm) Wall

- Perfect for lagging copper coils

Part No	Description	Pipe Size	Wall Size	Coils/Box
GMEU50	15mt Coils	1/4"(6mm)	3/8"	12
GMEU51	15mt Coils	3/8"(10mm)	3/8"	10
GMEU52	15mt Coils	1/2"(12mm)	3/8"	9
GMEU53	15mt Coils	3/4"(15mm)	3/8"	9
GMEU54	15mt Coils	1"(20mm)	3/8"	7
GMEU55	15mt Coils	1-1/8"(22mm)	3/8"	6
GMEU56	15mt Coils	1-3/8"(28mm)	3/8"	5

Bagged Coils Class 'O' Lagging 1/2" Wall



1/2" (13mm) Wall

Part No	Description	Pipe Size	Wall Size	Coils/Box
GMEU58	15mt Coils	1/4"(6mm)	1/2"	9
GMEU59	15mt Coils	3/8"(10mm)	1/2"	7
GMEU60	15mt Coils	1/2"(12mm)	1/2"	6
GMEU61	15mt Coils	3/4"(15mm)	1/2"	6
GMEU62	15mt Coils	1"(20mm)	1/2"	6
GMEU63	15mt Coils	1-1/8"(22mm)	1/2"	5
GMEU64	15mt Coils	1-3/8"(28mm)	1/2"	4



Boxed Coils Class 'O' Lagging 3/8" Wall

3/8" (9mm) Wall



Part No	Description	Pipe Size	Wall Size	Metres/Box
GMEU1	Boxed Coils	3/4"(6mm)	3/8"	70mt
GMEU2	Boxed Coils	3/4"(10mm)	3/8"	50mt
GMEU3	Boxed Coils	1/2"(12mm)	3/8"	45mt
GMEU4	Boxed Coils	3/8"(15mm)	3/8"	40mt
GMEU5	Boxed Coils	3/4"(20mm)	3/8"	34mt
GMEU80	Boxed Coils	3/8"(22mm)	3/8"	30mt
GMEU81	Boxed Coils	1-3/8"(28mm)	3/8"	26mt

Boxed Coils Class 'O' Lagging 1/2" Wall

1/2" (13mm) Wall



Part No	Description	Pipe Size	Wall Size	Metres/Box
GMEU6	Boxed Coils	3/4"(6mm)	1/2"	45mt
GMEU7	Boxed Coils	3/4"(10mm)	1/2"	35mt
GMEU8	Boxed Coils	1/2"(12mm)	1/2"	32mt
GMEU9	Boxed Coils	3/8"(15mm)	1/2"	32mt
GMEU10	Boxed Coils	3/4"(20mm)	1/2"	28mt
GMEU11	Boxed Coils	3/8"(22mm)	1/2"	26mt
GMEU12	Boxed Coils	1-3/8"(28mm)	1/2"	20mt

Class 'O' Lagging for Barrier Pipe

Part No	Description	Pipe Size	Wall Size	Metres/Box
GMEUC1325	Boxed Coils	1"(25mm)	1/2"	20mt

PVC Coated Weatherproof Lagging

1/2" (13mm) Wall



- PVC Coated External Grade Insulation
- External pipework needs to be insulated in a tough PVC coated weather protected covering to avoid UV degradation and animal damage.

Part No	Description	Pipe Size	Wall Size
GMVI18	PVC Coated 2mt Straights	3/4"(6mm)	1/2"
GMVI19	PVC Coated 2mt Straights	3/8"(10mm)	1/2"
GMVI20	PVC Coated 2mt Straights	1/2"(12mm)	1/2"
GMVI21	PVC Coated 2mt Straights	3/8"(15mm)	1/2"
GMVI22	PVC Coated 2mt Straights	3/4"(20mm)	1/2"
GMVI23	PVC Coated 2mt Straights	3/8"(22mm)	1/2"
GMVI24	PVC Coated 2mt Straights	1-3/8"(28mm)	1/2"
GMVI25	PVC Coated 2mt Straights	1-3/8"(35mm)	1/2"

PVC Coated Weatherproof Lagging

3/4" (19mm) Wall



- PVC Coated External Grade Insulation
- External pipework needs to be insulated in a tough PVC coated weather protected covering to avoid UV degradation and animal damage.

Part No	Description	Pipe Size	Wall Size
GMVI74	PVC Coated 2mt Straights	3/8"(22mm)	3/4"
GMVI75	PVC Coated 2mt Straights	1-3/8"(28mm)	3/4"
GMVI76	PVC Coated 2mt Straights	1-3/8"(35mm)	3/4"

Weatherproof Lagging for Barrier Pipe

Part No	Description	Pipe Size	Wall Size
GMVIH1325	PVC Coated 2mt Straights	1"(25mm)	1/2"

2mt Lengths Ultima Lagging 3/8" Wall



3/8" (9mm) Wall

- The first elastomer product with minimal smoke development (10x less smoke than the standard product)
- For sustainable construction (free from brominated flame retardants)
- Based on the patented Armaprene technology
- Specifically developed to create an insulation material that produces minimal smoke when burnt. (Euroclass B/BL - s1, d0)

Part No	Description	Pipe Size	Wall Size	Lengths/Box
GMUL15	2mt Straights	1/2"(12mm)	3/8"	96
GMUL16	2mt Straights	3/8"(15mm)	3/8"	90

2mt Lengths Ultima Lagging 1/2" Wall



1/2" (13mm) Wall

- The first elastomer product with minimal smoke development (10x less smoke than the standard product)
- For sustainable construction (free from brominated flame retardants)
- Based on the patented Armaprene technology
- Specifically developed to create an insulation material that produces minimal smoke when burnt. (Euroclass B/BL - s1, d0)

Part No	Description	Pipe Size	Wall Size	Lengths/Box
GMUL18	2mt Straights	3/4"(6mm)	1/2"	82
GMUL19	2mt Straights	3/4"(10mm)	1/2"	70
GMUL20	2mt Straights	1/2"(12mm)	1/2"	65
GMUL21	2mt Straights	3/8"(15mm)	1/2"	56

Ultima Lagging Tape



- Specifically designed for use in joining the Ultima insulation

Part No	Description	Size
GMUL30	Ultima Lagging Tape	3mm x 50mm x 15mt

THE FLEXIBLE TECHNICAL INSULATION
MATERIAL WITH EXTREMELY LOW SMOKE DENSITY
Self-extinguishing, does not drip nor spread flames

**Armaflex®
Ultima**



Lagging Tapes

STÖRNCH



- A closed cell Nitrile butadiene rubber blend with a high-strength acrylic adhesive on one side, reinforced with a scrim backing
- Excellent for applications in taping joints on Class '0' pipe insulation, along with the surfaces of seaming parts for tubes and rolls to reinforce the insulation systems
- Provides a fast and easy insulating method which can be conveniently applied on both irregular surfaces and in narrow working spaces

Part No	Description	Size	Qty/Box
GMEU30	STÖRNCH Lagging Tape	3mm x 50mm x 15mt	12
GMEU35	Armaflex Lagging Tape	3mm x 50mm x 15mt	12

Armaflex Lagging Adhesive



Armaflex adhesive recommended for every joint

- c/w application brush

Part No	Description	Size
GMEU31	Armaflex Adhesive	250ml



- Armaflex 520 Adhesive is a thin yellow glue for use with Armaflex insulation
- Specially formulated to create uniform and safe bonding of seams and butt joints, and for sticking Armaflex to clean metal surfaces
- Easy to apply, and fast drying; speeding up the installation
- The wide spanning temperatures that this adhesive can withstand, makes it suitable for a range of commercial and industrial applications

Armafinish Lagging Paint



- This coating is particularly suitable for the protection of Armaflex flexible thermal insulation materials against attack by sunlight, UV, radiation and chemicals
- The coating, when fully cured, maintains the flexibility, resistance to water vapour and fire performance of the Armaflex material

Part No	Description	Size
GMEU45	Armafinish Black Paint	2.5 ltr

Lagging Slitting Knife



- Specially designed by Armaflex as a tool for their products
- The rounded bar in front of the blade ensures a clean, constant cut, but stops the knife cutting into the pipe

Part No	Description
GMEU96	Lagging Slitting Knife

Armaflex Sheet Class '0' Insulation



- Often used for insulating small tanks & vessels
- Reduces heat losses by up to 87% due to stable thermal conductivity; meaning long term energy efficiency
- Built-in Microban® antimicrobial protection reduces mould and bacteria growth

Part No	Description	Size	Mt Per Roll
GMEU36R	Sheet Insulation	1mt x 9mm (3/8")	10mt
GMEU37R	Sheet Insulation	1mt x 13mm (1/2")	8mt

Releasable Cable Ties

- c/w a small release clip which allows you to undo and reattach them as required

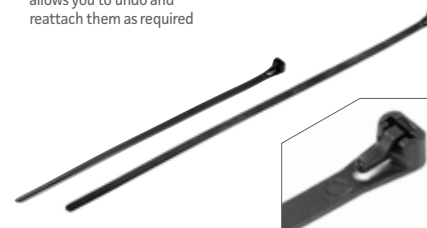

Part No	Description	Size	Qty/Pk
GM250HTD	Releasable Cable Ties	250mm x 7.6mm	pk 100
GM380HTD	Releasable Cable Ties	370mm x 7.6mm	pk 100

Cable Ties



- Used for fastening and securing insulation
- Wider cable ties are less likely to cut into insulation when fastened tightly

Part No	Description	Size	Qty/Pk
GM300I	Cable Ties	300mm x 3.6mm	pk 100
GM300ST	Cable Ties	300mm x 4.8mm	pk 100
GM300ST-NAT	Cable Ties (Natural)	300mm x 4.8mm	pk 100
GM300HD	Cable Ties	300mm x 7.6mm	pk 100
GM370ST	Cable Ties	370mm x 4.8mm	pk 100
GM380HD	Cable Ties	380mm x 7.6mm	pk 100
GM450HD	Cable Ties	430mm x 9.0mm	pk 100

Stainless Steel Cable Ties

- For use where additional strength, security and fire resistance is required
- Roller-ball locking mechanism
- 316 grade stainless steel

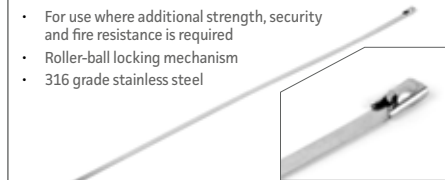

Part No	Description	Size	Qty/Pk
GM300STST	Stainless Steel Cable Ties	300mm x 4.8mm	pk 100

Cable Tie Bases



GMCTA1

- Push in fixing for cable ties up to 9mm wide
- Drill 6-8mm hole in brick, block, concrete or wood

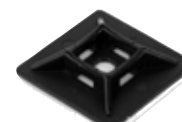

GMAM2

- Peel off backing paper and stick to surface



GMSM2

- Saddle design provides maximum stability
- Fix mounts with screw



Part No	Description	Size	Qty/Pk
GMCTA1	Cable Tie Anchors	37mm Long	pk 100
GMAM2	S/A Cable Tie Bases	28mm x 28mm	pk 100
GMSM2	Screw Tie Bases	Suits 4.8 - 8.0 Ties	pk 100



STÖRNCH Brazing Rods

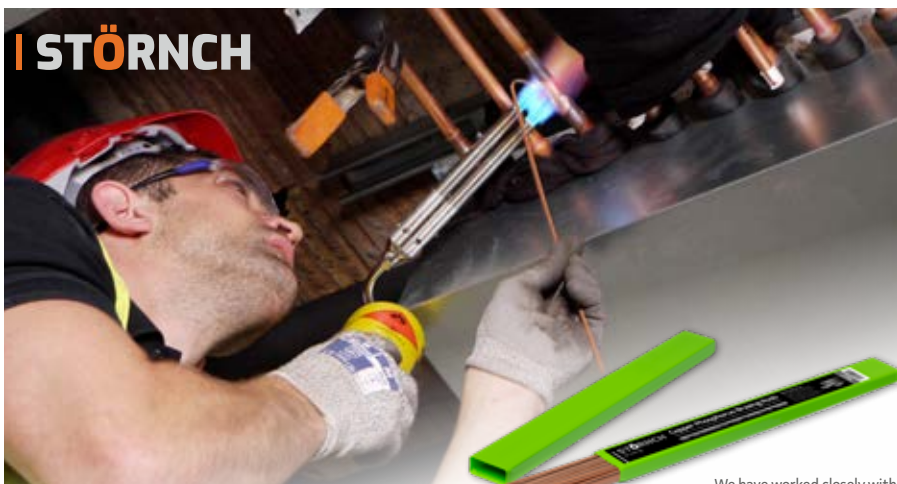

Part No	Description	Qty/Pk
GMBZR11	STÖRNCH Brazing Rods	1kg

We have worked closely with our customers to develop this range, the result being a high performance copper phosphorous rod providing exceptional value for money, making STÖRNCH the engineer's first choice for brazing rods

Rothenberger S2 Brazing Rods



- Quality, hard solder brazing rods
- Their low silver content, and the fact they are matched to normally-stressed copper pipe systems, makes them ideal for capillary gap soldering



Part No	Description	Qty/Pk
GMBZR10	Rothenberger S2 Brazing Rods	1kg

40% Silver Flux Coated Brazing Rods



- Common alloy used for brazing copper to brass, and other dissimilar metals
- Unique plasticised flux coating, to reduce the chipping and loss of flux

Part No	Description	Qty/Pk
GMBZR4	40% Silver (Flux Coated)	5 Rods

Powder Flux



- Specially developed flux used in conjunction with brazing alloys, melting within the temperature range 500 – 850°C

Part No	Description	Qty/Pk
GMBZR6	Powder Flux	250g

Turbo Set 1000 Portable Brazing Kit



- Sturdy portable brazing kit weighing only 5kg
- 2 metre hoses fitted with blow back valves
- Maxy Gas Oxygen combination which attains temperatures up to 3050°C
- Kit complete with welding goggles, lighter, spanner and brazing rods
- Cylinders included

Part No	Description
GMBZT7	Turbo Set 1000 Portable Brazing Kit

Turbo Set Gas Refills



- Specifically for Turbo Set 1000

Part No	Description	Size
GMBZC1	Oxygen Bottle	950ml
GMBZC2	Maxy Gas Bottle	350g

Map Gas



For a complete range of brazing torches and tools, see pages: 217-218

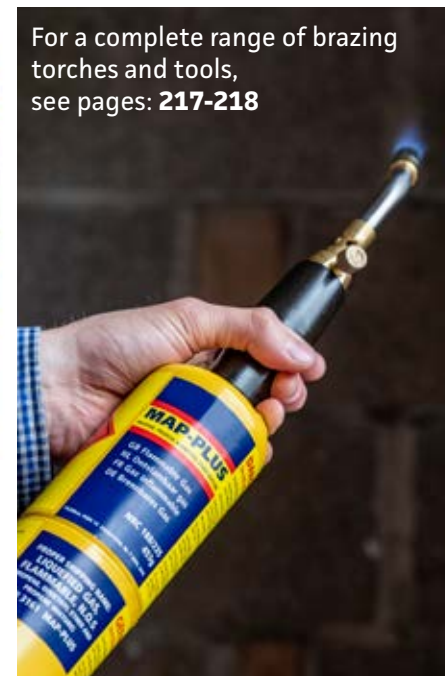

- For use with professional type brazing and soldering torches
- Extremely high flame temperature, great burning performance and guaranteed short working times

Part No	Description	Qty/Box
GMBZC3	Propane Gas Bottle	12
GMBZC4	Map-Plus Gas Bottle	12
GMBZC4-R	Rothenberger Mapp Gas Bottle	12

R32 Refrigerant



- HFC refrigerant is increasingly used to replace other refrigerants because of its lower GWP (Global Warming Potential)
- Please note, does not include left hand thread bottle adaptor. These are available separately – (right) GMRT32A
- Mildly flammable

Part No	Description	Size
GMRT32	R32 Refrigerant	9 kg

R32 Bottle Adapter



- Manufactured from brass
- Comes with a washer seal
- Left hand thread

Also see page 227

Part No	Description	Qty/Pk
GMRT32A	R32 Bottle Adapter	Each

R410A Refrigerant



- R410A is found in many AC systems and has a higher GWP than R32
- Low toxicity - Non flammable
- c/w Bottle Adapter

Part No	Description	Size
GMRT10	R410a Refrigerant	10 kg

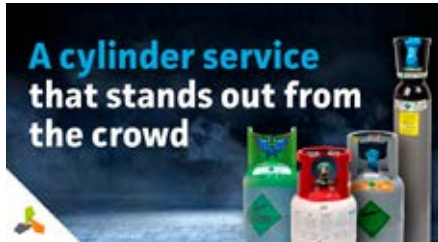

Unrivalled in the industry, thanks to:

- **FREE** Collection Service – no minimum quantity
- Huge stocks of Nitrogen, refrigerant gas, and reclaim
- Deliveries on our own vans with live vehicle tracking
- Online Cylinder Tracking Tool

R407C Refrigerant



- R407C is an HFC blend of refrigerant for AC systems
- c/w Bottle Adapter

Part No	Description	Size
GMRT4	R407C Refrigerant	11.5 kg

R134a Refrigerant



- R134a is an HFC refrigerant commonly used in HFC & refrigeration systems
- c/w Bottle Adapter

Part No	Description	Size
GMRT2	R134a Refrigerant	12 kg

Nitrogen (OFN) Cylinders



- Oxygen-free Nitrogen
- Usually used for purging and pressure testing

Part No	Description	Size
GMRT13	Nitrogen (OFN) Cylinder	10 ltr

Nitrogen Trolley



- Retractable handle cylinder trolley
- Cylinder not included

Part No	Description	Qty/Pk
GMNT	Nitrogen Trolley	Each

Reclaim Cylinders (Green Tops)



- Cylinders are 9kg capacity
- Supplied cleaned and sealed, and can be used as receivers
- Not to be used for R32 or A2L flammable gases
- Double valve, double port c/w 3/4" SAE MFL outlet
- Contents can be any number of mixed refrigerants
- Cylinders returned to us must be accompanied by a fully completed waste transfer note supplied

Part No	Description	Max Capacity
GMRT11	Reclaim Cylinder	9kg

R32 Recovery Cylinder



- These take all A2L refrigerants, including R32
- The maximum fill is 9kg, we recommend filling to 8kg
- These are a left hand thread valve and will need an adaptor (GMRT32A)
- They have a dual port valve, and if you use both taps (liquid and vapour) you will need 2 adaptors
- Cylinders returned to us must be accompanied by a fully completed waste transfer note supplied

Part No	Description	Max Capacity
GMRT33	R32 Recovery Cylinder	9kg
GMRT32A	R32 Bottle Adapter	Each

Cylinder Heating Belt - 110V



- Heats cylinders to 50°C to increase the pressure of the refrigerant
- Speeds up recharging time
- Assures total discharge of refrigerants from cylinders
- 300W heater element

Part No	Description	Voltage
GMCHB110	Cylinder Heating Belt	110V

Air Conditioning Trunking

Contents

Tecno Black Trunking	89 - 90
Tecno Ivory Trunking	91 - 93
Inaba Denko Black Trunking	94 - 95
SpeediDuct White Trunking	96 - 98
SpeediDuct Ivory Trunking	99 - 101
Maxi & Mini White Trunking	102



Tecno Black Straight Duct



- Easy to install and adds the finishing touches to an air conditioning, refrigeration, or heating installation by covering up unsightly pipework and giving a clean aesthetic finish
- Fire resistant and weatherproof, meaning it can be used internally or externally
- 72mm duct range is for pipe sizes up to 3/8" and 1/2" with 13mm insulation

Part No	Description	Size
GMTBSD72	Tecno Black Straight Duct	72mm x 2mt

Tecno Black Wall Cap (Rosette)



- Used to conceal the hole around trunking, at the point where it goes into a wall or ceiling

Part No	Description	Size
GMTBWC72	Tecno Black Wall Cap (Rosette)	72mm

Tecno Black Coupling



- Joining piece for straight ducts

Part No	Description	Size
GMTBC72	Tecno Black Coupling	72mm

Tecno Black Corner Cap



- Conceals the hole around trunking in a corner, at the point where it goes into a wall or ceiling

Part No	Description	Size
GMTBCC72	Tecno Black Corner Cap	72mm

Tecno Black 90° Vertical Elbow



- An elbow for joining trunking on a vertical plane

Part No	Description	Size
GMTBVE72	Tecno Black 90° Vertical Elbow	72mm

Tecno Black 90° Horizontal Elbow



- An elbow for joining trunking on a horizontal plane

Part No	Description	Size
GMTBHE72	Tecno Ivory 90° Horizontal Elbow	72mm

Tecno Black Vertical Universal Elbow



- Adjustable elbow for joining Tecno trunking on a vertical plane

Part No	Description	Size
GMTBVUE72	Tecno Black Vertical Universal Elbow	72mm

Tecno Black Horizontal Universal Elbow



- Adjustable elbow for joining Tecno trunking on a horizontal plane

Part No	Description	Size
GMTBHUE72	Tecno Black Horizontal Universal Elbow	72mm

Tecno Black Tee Joint



- A tee piece for joining Tecno trunking

Part No	Description	Size
GMTBTJ72	Tecno Black Tee Joint	72mm (c/w reducers)

Tecno Black Outlet Cover



- A wall cover for Tecno trunking where pipes come through a wall

Part No	Description	Size
GMTBOC72	Tecno Black Outlet Cover	72mm

Tecno Black End Socket



- Provides a neat finish where the trunking terminates but the pipework continues

Part No	Description	Size
GMTBES72	Tecno Black End Socket	72mm

Tecno Black End Cap



- Used for capping off where both the pipework and trunking terminates

Part No	Description	Size
GMTBEC72	Tecno Black End Cap	72mm

Tecno Ivory Straight Duct



- Easy to install and adds the finishing touches to an air conditioning, refrigeration, or heating installation by covering up unsightly pipework and giving a clean aesthetic finish
- Fire resistant and weatherproof, meaning it can be used internally or externally
- 100mm duct range is for pipe sizes up to 3/4" and 7/8" with 13mm insulation
- 72mm duct range is for pipe sizes up to 3/8" and 7/8" with 13mm insulation

Part No	Description	Size
GMT72	Tecno Ivory Straight Duct	72mm x 2mt
GMT100	Tecno Ivory Straight Duct	100mm x 2mt

Tecno Ivory Couplings



- Joining piece for straight ducts

Part No	Description	Size
GMT101	Tecno Ivory Coupling	72mm
GMT102	Tecno Ivory Coupling	100mm

Tecno Ivory Corner Caps



- Conceals the hole around trunking in a corner, at the point where it goes into a wall or ceiling

Part No	Description	Size
GMT113	Tecno Ivory Corner Cap	72mm
GMT114	Tecno Ivory Corner Cap	100mm

Tecno Ivory 90° Vertical Elbows



- An elbow for joining trunking on a vertical plane

Part No	Description	Size
GMT108	Tecno Ivory 90° Vertical Elbow	72mm
GMT109	Tecno Ivory 90° Vertical Elbow	100mm

Tecno Ivory 90° Horizontal Elbows



- An elbow for joining trunking on a horizontal plane

Part No	Description	Size
GMT105	Tecno Ivory 90° Horizontal Elbow	72mm
GMT106	Tecno Ivory 90° Horizontal Elbow	100mm

Tecno Ivory Vertical Universal Elbow



- Adjustable elbow for joining Tecno trunking on a vertical plane

Part No	Description	Size
GMT110	Tecno Ivory Vertical Universal Elbow	72mm

Tecno Ivory Horizontal Universal Elbow



- Adjustable elbow for joining Tecno trunking on a horizontal plane

Part No	Description	Size
GMT107	Tecno Ivory Horizontal Universal Elbow	72mm

Tecno Ivory Tee Joints



- A tee piece for joining Tecno trunking

Part No	Description	Size
GMT119	Tecno Ivory Tee Joint	72mm (c/w reducers)
GMT120	Tecno Ivory Tee Joint	100mm

Tecno Ivory Outlet Covers



- A wall cover for Tecno trunking where pipes come through a wall

Part No	Description	Size
GMT103	Tecno Ivory Outlet Cover	72mm
GMT104	Tecno Ivory Outlet Cover	100mm

Tecno Ivory End Sockets



- Provides a neat finish where the trunking terminates but the pipework continues

Part No	Description	Size
GMT117	Tecno Ivory End Socket	72mm
GMT118	Tecno Ivory End Socket	100mm

Tecno Ivory End Caps



- Used for capping off where both the pipework and trunking terminates

Part No	Description	Size
GMT115	Tecno Ivory End Cap	72mm
GMT116	Tecno Ivory End Cap	100mm

Tecno Ivory Flexible Couplings



- A flexible joining piece for Tecno trunking

Part No	Description	Size
GMT124	Tecno Ivory Flexible Coupling	72mm
GMT125	Tecno Ivory Flexible Coupling	100mm

Tecno Ivory Wall Caps (Rosette)



- Used to conceal the hole around trunking, at the point where it goes into a wall or ceiling

Part No	Description	Size
GMT111	Tecno Ivory Wall Cap (Rosette)	72mm
GMT112	Tecno Ivory Wall Cap (Rosette)	100mm



Featuring a Tecno outlet cover

Inaba Denko Black Trunking - Straight Lengths



- Easy to install
- Accommodates both the insulated flow and return pipe work and other associated cabling
- Provides a professional and neat finish

Part No	Description	Size
GMTB75	Black Trunking	75mm x 2mt
GMTB100	Black Trunking	100mm x 2mt
GMHPTB	Black Trunking	140mm x 2mt

- Made from high grade fade-resistant PVC
- Provides protection from the elements, accidental & pest damage
- 100mm duct range for pipe sizes up to 3/4" and 1/2" with 13mm insulation
- 75mm duct range is for pipe sizes up to 3/8" and 1/4" with 13mm insulation
- 140mm duct range is suited to multiple pipe runs including heat pump installations

Inaba Denko Black Couplers



- Straight joining piece for black trunking

Part No	Description	Size
GMTB75CP	Black Coupler	75mm
GMTB100CP	Black Coupler	100mm
GMHPTSCB	Black Coupler	140mm

Inaba Denko Black Corner Caps



- Conceals the hole around trunking in a corner, at the point where it goes into a wall or ceiling

Part No	Description	Size
GMTB75CC	Black Corner Cap	75mm
GMTB100CC	Black Corner Cap	100mm

Inaba Denko Black 90° Vertical Elbows



- 90° elbow for joining black trunking in a vertical plane

Part No	Description	Size
GMTB75VE	Black 90° Vertical Elbow	75mm
GMTB100VE	Black 90° Vertical Elbow	100mm
GMHPTBEB	Black 90° Vertical Elbow	140mm

Inaba Denko Black 90° Flat Elbows



- 90° elbow for joining black trunking in a horizontal plane

Part No	Description	Size
GMTB75FE	Black 90° Flat Elbow	75mm
GMTB100FE	Black 90° Flat Elbow	100mm
GMHPTFBB	Black 90° Flat Elbow	140mm

Inaba Denko Black 45° Vertical Elbows



- 90° elbow for joining black trunking on a vertical plane

Part No	Description	Size
GMTB7545VE	Black 45° Vertical Elbow	75mm
GMTB10045VE	Black 45° Vertical Elbow	100mm

Inaba Denko Black 45° Flat Elbows



- 45° elbow for joining black trunking on a horizontal plane

Part No	Description	Size
GMTB7545FE	Black 45° Flat Elbow	75mm
GMTB10045FE	Black 45° Flat Elbow	100mm

Inaba Denko Black Tee Joints



- A Tee piece for joining or reducing black trunking

Part No	Description	Size
GMTB75TJ	Black Tee Joint	75mm
GMTB100TJ	Black Tee Joint	100mm

Inaba Denko Black Wall Covers



- An outlet cover for black trunking where pipes come through a wall

Part No	Description	Size
GMTB75WC	Black Wall Cover	75mm
GMTB100WC	Black Wall Cover	100mm

Inaba Denko Black Offset Joints



- A handy 50mm offset joint for fitting around a variety of obstructions

Part No	Description	Size
GMTB75J	Black Offset Joint	75mm
GMTB100J	Black Offset Joint	100mm



SpeediDuct White Trunking - Straight Lengths



Part No	Description	Width	Depth	Length
GMTWD70	White Trunking	70mm	65mm	2mt
GMTWD105	White Trunking	105mm	75mm	2mt

- Adds the finishing touches to an air conditioning installation
- Easy to install, fire resistant & weatherproof
- 105mm duct range is for pipe sizes up to 3/4" and 1" with 13mm insulation
- 70mm Duct range is for pipe sizes up to 3/8" and 1/2" with 13mm insulation

SpeediDuct White Couplers

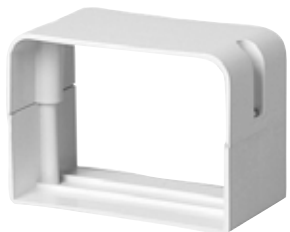

- Straight joining piece for SpeediDuct trunking

Part No	Description	Size
GMTWD70CP	SpeediDuct White Coupler	70mm
GMTWD105CP	SpeediDuct White Coupler	105mm

SpeediDuct White Duct Ends



- Provides a neat finish where the trunking terminates but the pipework continues

Part No	Description	Size
GMTWD70DE	SpeediDuct White Duct End	70mm
GMTWD105DE	SpeediDuct White Duct End	105mm

SpeediDuct White External Elbows



- 90° elbow for external corners

Part No	Description	Size
GMTWD70EE	SpeediDuct White External Elbow	70mm
GMTWD105EE	SpeediDuct White External Elbow	105mm

SpeediDuct White Internal Elbows



- 90° elbow for internal corners

Part No	Description	Size
GMTWD70EB	SpeediDuct White Internal Elbow	70mm
GMTWD105EB	SpeediDuct White Internal Elbow	105mm

SpeediDuct White 90° Flat Bends



- 90° elbow for joining SpeediDuct trunking on a horizontal plane

Part No	Description	Size
GMTWD70FB	SpeediDuct White 90° Flat Bend	70mm
GMTWD105FB	SpeediDuct White 90° Flat Bend	105mm

SpeediDuct White 45° Flat Bends

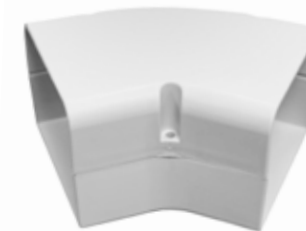

- 45° elbow for joining SpeediDuct trunking on a horizontal plane

Part No	Description	Size
GMTWD7045FB	SpeediDuct White 45° Flat Bend	70mm
GMTWD10545FB	SpeediDuct White 45° Flat Bend	105mm

SpeediDuct White Tee Joint



- A tee piece for joining SpeediDuct trunking
- If using with 70mm then reducer joints will be required

Part No	Description	Size
GMTWD105TJ	SpeediDuct White Tee Joint	105mm

SpeediDuct White Reducer Joint



- For reducing from 105mm SpeediDuct trunking to 70mm

Part No	Description	Size
GMTWD10570RJ	SpeediDuct White Reducer Joint	105-70mm

SpeediDuct White Wall Rosettes



- Used to conceal the hole around trunking, at the point where it goes into a wall or ceiling

Part No	Description	Size
GMTWD70WR	SpeediDuct White Wall Rosette	70mm
GMTWD105WR	SpeediDuct White Wall Rosette	105mm

SpeediDuct White Flat Rosettes



- Conceals the hole around trunking in a corner, at the point where it goes into a wall or ceiling

Part No	Description	Size
GMTWD70FR	SpeediDuct White Flat Rosette	70mm
GMTWD105FR	SpeediDuct White Flat Rosette	105mm

SpeediDuct White Wall Covers



- An outlet cover for SpeediDuct trunking where pipes come through the wall

Part No	Description	Size
GMTWD70WC	SpeediDuct White Wall Cover	70mm
GMTWD105WC	SpeediDuct White Wall Cover	105mm

SpeediDuct White Duct Caps

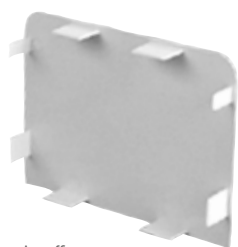

- Used for capping off SpeediDuct trunking straight lengths

Part No	Description	Size
GMTWD70DC	SpeediDuct White Duct Cap	70mm
GMTWD105DC	SpeediDuct White Duct Cap	105mm

SpeediDuct White Flexi Hose Kits



- Protects your line sets from the condenser unit to the wall.
- Saving time when connecting 2 ducts
- 1x Flexible hose: length 1m / 39.4"
- 2x Flex connector
- 1x Flex-end
- 1x Stainless steel clamp



Part No	Description	Size
GMTWD70FH	SpeediDuct White Flexi Hose Kit	70mm
GMTWD105FH	SpeediDuct White Flexi Hose Kit	105mm

SpeediDuct Ivory Trunking - Straight Lengths



- Adds the finishing touches to an air conditioning installation
- Easy to install, fire resistant & weatherproof
- 105mm duct range is for pipe sizes up to 3/4" and 1/2" with 13mm insulation
- 70mm duct range is for pipe sizes up to 3/8" and 1/4" with 13mm insulation
- 140mm duct range is suited to multiple pipe runs including heat pump installations

Part No	Description	Width	Depth	Length
GMTD70	SpeediDuct Ivory	70mm	65mm	2mt
GMTD105	SpeediDuct Ivory	105mm	75mm	2mt
GMHPTI	Ivory Trunking	140mm	90mm	2mt

SpeediDuct Ivory Couplers



- Straight joining piece for SpeediDuct trunking

Part No	Description	Size
GMTD70CP	SpeediDuct Ivory Coupler	70mm
GMTD105CP	SpeediDuct Ivory Coupler	105mm

Ivory Coupler



- For joining straight lengths of trunking

Part No	Description	Size
GMHPTSCI	Ivory Coupler	140mm

SpeediDuct Ivory Duct Ends



- Provides a neat finish where the trunking terminates but the pipework continues

Part No	Description	Size
GMTD70DE	SpeediDuct Ivory Duct End	70mm
GMTD105DE	SpeediDuct Ivory Duct End	105mm

SpeediDuct Ivory Duct Caps



- Used for capping off SpeediDuct trunking straight lengths

Part No	Description	Size
GMTD70DC	SpeediDuct Ivory Duct Cap	70mm
GMTD105DC	SpeediDuct Ivory Duct Cap	105mm

SpeediDuct Ivory Internal Elbows



- 90° elbow for internal corners

Part No	Description	Size
GMTD70EB	SpeediDuct Ivory Internal Elbow	70mm
GMTD105EB	SpeediDuct Ivory Internal Elbow	105mm

Ivory Internal Elbow



- 90° Elbow for Internal corners

Part No	Description	Size
GMHPTIBI	Ivory Internal Elbow	140mm

SpeediDuct Ivory External Elbows



- 90° elbow for external corners

Part No	Description	Size
GMTD70EE	SpeediDuct Ivory External Elbow	70mm
GMTD105EE	SpeediDuct Ivory External Elbow	105mm
GMHPTEBI	Ivory External Elbow	140mm

SpeediDuct Ivory 45° Flat Bends



- 45° elbow for joining SpeediDuct trunking on a horizontal plane

Part No	Description	Size
GMTD7045FB	SpeediDuct Ivory 45° Flat Bend	70mm
GMTD10545FB	SpeediDuct Ivory 45° Flat Bend	105mm

SpeediDuct Ivory 90° Flat Bends



- 90° elbow for joining SpeediDuct trunking on a horizontal plane

Part No	Description	Size
GMTD70FB	SpeediDuct Ivory 90° Flat Bend	70mm
GMTD105FB	SpeediDuct Ivory 90° Flat Bend	105mm

Ivory 90° Flat Bend



- 90° elbow for joining 140mm trunking on a horizontal plane

Part No	Description	Size
GMHPTFBI	Ivory 90° Flat Bend	140mm

SpeediDuct Ivory Wall Covers



140mm Wall Cover

- An outlet cover for trunking where pipes come through the wall

Part No	Description	Size
GMTD70WC	SpeediDuct Ivory Wall Cover	70mm
GMTD105WC	SpeediDuct Ivory Wall Cover	105mm
GMHPTWCI	Ivory Wall Cover	140mm

SpeediDuct Ivory Tee Joint



- A tee piece for joining SpeediDuct trunking
- If using with 70mm then reducer joints will be required

Part No	Description	Size
GMTD105TJ	SpeediDuct Ivory Tee Joint	105mm

SpeediDuct Ivory Flat Rosettes



- Conceals the hole around trunking in a corner, at the point where it goes into a wall or ceiling

Part No	Description	Size
GMTD70FR	SpeediDuct Ivory Flat Rosette	70mm
GMTD105FR	SpeediDuct Ivory Flat Rosette	105mm

SpeediDuct Ivory Wall Rosettes



- Used to conceal the hole around trunking, at the point where it goes into a wall or ceiling

Part No	Description	Size
GMTD70WR	SpeediDuct Ivory Wall Rosette	70mm
GMTD105WR	SpeediDuct Ivory Wall Rosette	105mm

SpeediDuct Ivory Reducer Joint



- For reducing from 105mm SpeediDuct trunking to 70mm

Part No	Description	Size
GMTD10570RJ	SpeediDuct Ivory Reducer Joint	105-70mm

SpeediDuct Ivory Flexi Hose Kits



- Protects your lines etc from the condenser unit to the wall.
- Saving time when connecting 2 ducts
- 1x Flexible hose: length 1m / 39.4"
- 2x Flex connector
- 1x Flex-end
- 1x Stainless steel clamp

Part No	Description	Size
GMTD70FH	SpeediDuct Ivory Flexi Hose Kit	70mm
GMTD105FH	SpeediDuct Ivory Flexi Hose Kit	105mm

Maxi White Trunking - Straight Lengths

- Designed to protect as well as hide unsightly piping, wiring, or cables from sight
- Provides weatherproofing for your system, extending the life in a cost-effective manner
- Extremely quick and easy to install, securely attaching to walls or floors

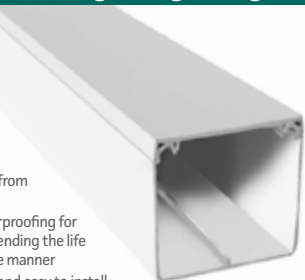

Part No	Description	Size	Length
GMMT7	Maxi White Trunking	75mm x 75mm	3mt
GMMT8	Maxi White Trunking	100mm x 100mm	3mt

Maxi White Flat Angles

- 90° elbow for joining Maxi trunking on a horizontal plain



Part No	Description	Size
GMMT12	Maxi White Flat Angle	75mm x 75mm
GMMT13	Maxi White Flat Angle	100mm x 100mm

Maxi White Inside Angles

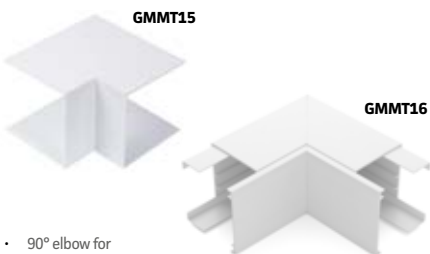

- 90° elbow for internal corners

Part No	Description	Size
GMMT15	Maxi White Inside Angle	75mm x 75mm
GMMT16	Maxi White Inside Angle	100mm x 100mm

Maxi White Outside Angles



- 90° elbow for external corners

Part No	Description	Size
GMMT18	Maxi White Outside Angle	75mm x 75mm
GMMT19	Maxi White Outside Angle	100mm x 100mm

Maxi White End Caps

- For capping-off Maxi trunking straight lengths



Part No	Description	Size
GMMT24	Maxi White End Cap	75mm x 75mm
GMMT25	Maxi White End Cap	100mm x 100mm

Mini White Self Adhesive Trunking

- Self adhesive
- Compact & discreet design
- Ideal for control cable
- Easily cut to size



Part No	Description	Size	Length
GMMT3	Self Adhesive Mini Trunking	16mm x 16mm	3mt

Pressfit Solutions

Contents

RLS Braze-Free Tool & Accessories	104
RLS Pressfit Jaws	105
RLS Accessories	106
RLS Braze-Free Fittings	107 - 108
Conex MaxiPro Press Tool	109
Conex MaxiPro Press Tool, Jaws & Accessories	110
Conex MaxiPro Fittings	111 - 113
Pressfit Ancillaries	114

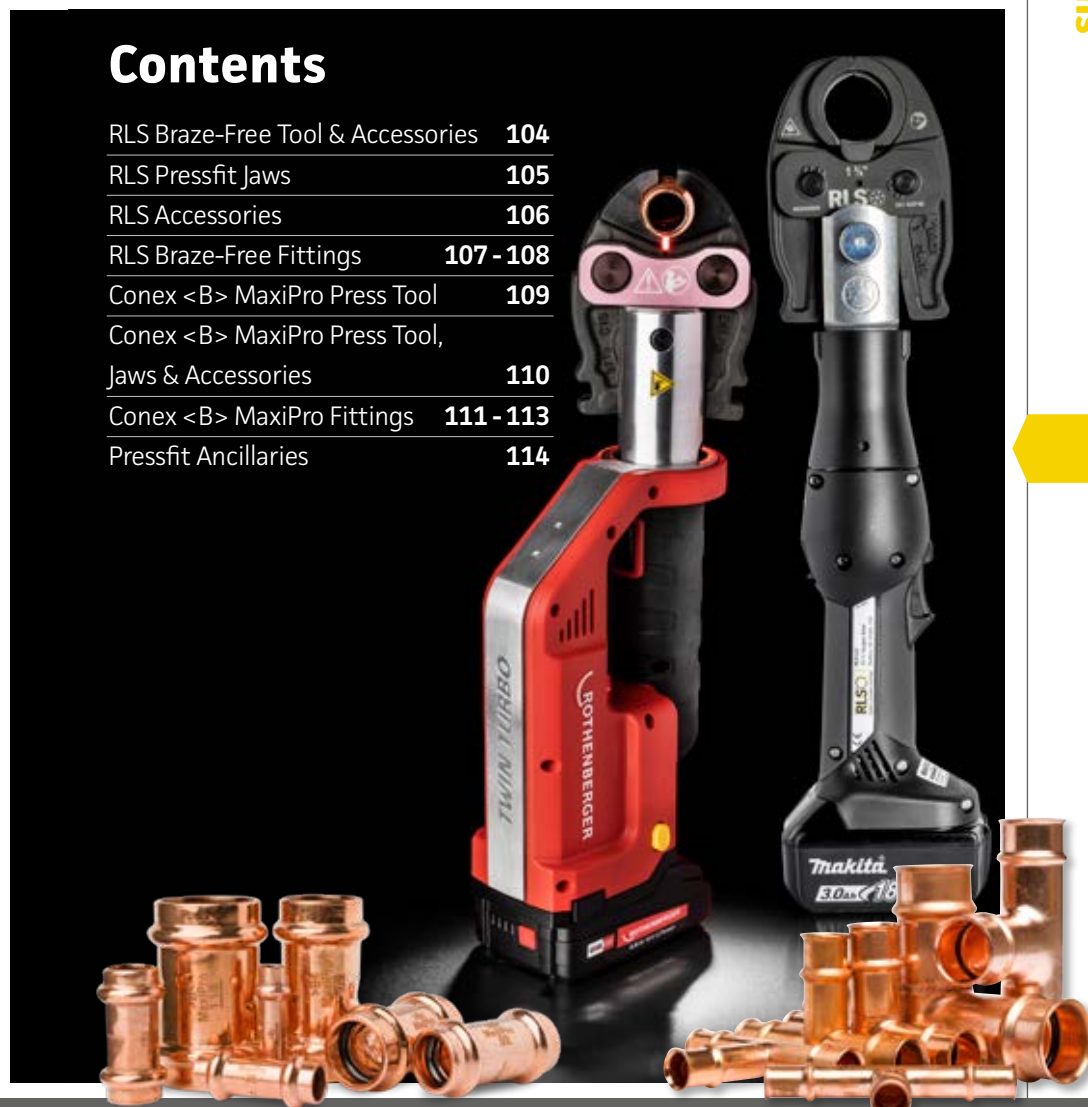

RLS 19kN Press Tool Kit

This RLS tool kit is a universal kit for both Hybrid and Braze-free refrigeration jointing systems

Purchase this press tool kit and then simply buy the jaws as and when you need them. Add Makita charger and battery if required

Startup Kit Includes:

- 19kN RLS Crimping Tool
- Tube Cutter
- Deburring Tool
- Crimp Gauge
- Depth Gauge
- Stainless Steel Brush
- Abrasive Pad
- Permanent Marker



No jaws, batteries or charger included

Part No	Description
GMZLTOOL138-NB	19kN RLS Press Tool Kit & Case

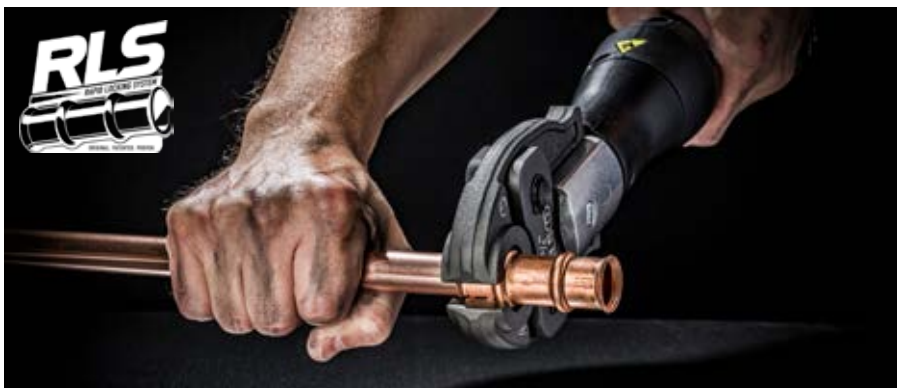

Makita 18V Fast Charger



- Extremely fast charging time

Part No	Description
GMZLCHAR	Makita 18v Battery Charger

Makita 18V Battery



- High performance rechargeable battery

Part No	Description
GMZLBAT15	Makita 18v Rechargeable Battery

19kN RLS Jaws



- Patented concentric crimping jaws
- Applies perfectly even pressure all around the 'o-ring' and copper tube

- Compatible with the 19kN RLS and Rothenberger press tools

Part No	Description	Size
GMZL231	RLS Jaw	¼"
GMZL232	RLS Jaw	¾"
GMZL233	RLS Jaw	½"
GMZL234	RLS Jaw	¾"

Part No	Description	Size
GMZL235	RLS Jaw	¾"
GMZL236	RLS Jaw	¾"
GMZL237	RLS Jaw	1-¾"
GMZL238	RLS Jaw	1-¾"

Copper M Press Fit Jaws



- For copper pressfit system
- 15kN jaws compatible with 15kN press tool
- 19kN jaws compatible with the 19kN RLS & Rothenberger press tools
- M-Profile

Part No	Description	Capacity	Size
GMCPJ16	Copper Pressfit Jaw	15kN	15mm
GMCPJ23	Copper Pressfit Jaw	15kN	22mm
GMCPJ29	Copper Pressfit Jaw	15kN	28mm
GMCPJ15	Copper Pressfit Jaw	19kN	15mm
GMCPJ22	Copper Pressfit Jaw	19kN	22mm
GMCPJ28	Copper Pressfit Jaw	19kN	28mm
GMCPJ35	Copper Pressfit Jaw	19kN	35mm

Barrier Pipe Pressfit Jaws



- For barrier pressfit system
- 15kN Jaws compatible with 15kN press tool
- 19kN Jaws compatible with the 19kN RLS & Rothenberger press tools
- U-Profile

Part No	Description	Capacity	Size
GMUPJ21	Barrier Pressfit Jaw	15kN	20mm
GMUPJ25	Barrier Pressfit Jaw	15kN	25mm
GMUPJ33	Barrier Pressfit Jaw	15kN	32mm
GMUPJ20	Barrier Pressfit Jaw	19kN	20mm
GMUPJ26	Barrier Pressfit Jaw	19kN	25mm
GMUPJ32	Barrier Pressfit Jaw	19kN	32mm
GMUPJ40	Barrier Pressfit Jaw	19kN	40mm

Carry Case for RLS Jaws



Part No	Description
GMZL209	Carry Case for RLS Jaws



- Hard plastic case with foam lining
- Protective storage for full set of 8 jaws (jaws not included)

Deburring Tool



- Removes any internal or external burrs from copper tube
- RLS approved

Part No	Description
GMZL007	Deburring Tool

Abrasive Pad & Marker Pen



- Abrasive pad for cleaning the copper tubing prior to crimping
- Marks on most surfaces
- Use with the insertion depth gauge to mark the tube

Part No	Description	Qty/Pk
GMZL020	Abrasive Pad	Each
GMPMP	Permanent Marker Pen	pk 6

RLS Crimp Gauge



- Confirms the measurement of the finished crimp band diameter

Part No	Description
GMZL005	RLS Crimp Gauge

RLS Insertion Depth Gauge



- Confirms the proper insertion depth of the tubing

Part No	Description
GMZL014	RLS Insertion Depth Gauge

RLS Connectors



- For joining refrigeration copper tubes

Part No	Description	Size	Qty/Pk
GMZL501-10	RLS Connector	1/4"	pk 10
GMZL502-10	RLS Connector	3/8"	pk 10
GMZL503-10	RLS Connector	1/2"	pk 10
GMZL504-10	RLS Connector	5/8"	pk 10
GMZL505-10	RLS Connector	3/4"	pk 10
GMZL506-10	RLS Connector	7/8"	pk 10
GMZL507-10	RLS Connector	1-1/8"	pk 10
GMZL508-12	RLS Connector	1-3/8"	pk 12

RLS 45° Elbows



- For joining refrigeration copper tubes

Part No	Description	Size
GMZL402	RLS 45° Long Radius Elbow	3/8"
GMZL403	RLS 45° Long Radius Elbow	1/2"
GMZL404	RLS 45° Long Radius Elbow	3/4"
GMZL405	RLS 45° Long Radius Elbow	1"
GMZL406	RLS 45° Long Radius Elbow	1-1/4"
GMZL407	RLS 45° Long Radius Elbow	1-1/2"
GMZL408	RLS 45° Long Radius Elbow	1-3/4"

RLS 90° Long Radius Elbows



- For joining refrigeration copper tubes

Part No	Description	Size
GMZL601	RLS 90° Long Radius Elbow	1/4"
GMZL602	RLS 90° Long Radius Elbow	3/8"
GMZL603	RLS 90° Long Radius Elbow	1/2"
GMZL604	RLS 90° Long Radius Elbow	5/8"
GMZL605	RLS 90° Long Radius Elbow	3/4"
GMZL606	RLS 90° Long Radius Elbow	7/8"
GMZL607	RLS 90° Long Radius Elbow	1-1/8"
GMZL608	RLS 90° Long Radius Elbow	1-3/8"

RLS Euro Flare Fittings



- For connecting to flare unions

Part No	Description	Size
GMZL1001	RLS Euro Flare Fitting	1/4" SAE
GMZL1002	RLS Euro Flare Fitting	3/8" SAE
GMZL1003	RLS Euro Flare Fitting	1/2" SAE
GMZL1004	RLS Euro Flare Fitting	3/4" SAE

RLS End Caps



• For capping the ends of refrigeration copper tubes

Part No	Description	Size
GMZL901	RLS End Cap	¼"
GMZL902	RLS End Cap	⅜"
GMZL903	RLS End Cap	½"
GMZL904	RLS End Cap	⅝"
GMZL905	RLS End Cap	¾"
GMZL906	RLS End Cap	⅞"
GMZL907	RLS End Cap	1-¼"
GMZL908	RLS End Cap	1-⅜"

RLS Equal Tees



• For joining refrigeration copper tubes

Part No	Description	Size
GMZL702	RLS Equal Tee	⅜"
GMZL703	RLS Equal Tee	½"
GMZL704	RLS Equal Tee	⅝"
GMZL705	RLS Equal Tee	¾"
GMZL706	RLS Equal Tee	⅞"
GMZL707	RLS Equal Tee	1-¼"
GMZL708	RLS Equal Tee	1-⅜"

RLS Reducing Couplings

Part No	Description	Size
GMZL800	RLS Reducing Coupling	⅝"-¾" C x C
GMZL808	RLS Reducing Coupling	¾"-¾" C x C
GMZL801	RLS Reducing Coupling	¾"-¾" C x C
GMZL809	RLS Reducing Coupling	¾"-¾" C x C
GMZL810	RLS Reducing Coupling	¾"-¾" C x C
GMZL802	RLS Reducing Coupling	¾"-¾" C x C
GMZL811	RLS Reducing Coupling	¾"-¾" C x C
GMZL803	RLS Reducing Coupling	¾"-¾" C x C
GMZL812	RLS Reducing Coupling	¾"-¾" C x C
GMZL804	RLS Reducing Coupling	¾"-¾" C x C
GMZL805	RLS Reducing Coupling	¾"-¾" C x C
GMZL813	RLS Reducing Coupling	1-¼"-¾" C x C
GMZL814	RLS Reducing Coupling	1-¼"-¾" C x C
GMZL806	RLS Reducing Coupling	1-¼"-¾" C x C
GMZL807	RLS Reducing Coupling	1-¼"-¾" C x C
GMZL818	RLS Reducing Coupling	1-¼"-¾" C x C
GMZL819	RLS Reducing Coupling	1-¼"-¾" C x C



• For joining refrigeration copper tubes

Rothenberger Romax Compact Tool Set c/w Jaws & Accessories

This Rothenberger tool kit is a universal kit for both Hybrid and Braze-free refrigeration jointing systems



- Startup Kit Includes:
- 19kN Press Tool
- Tube Cutter
- Deburring Tool
- Deburring Pencil
- Depth Gauge
- Abrasive Pads
- Permanent Marker
- 18v Battery
- Charger
- Rothenberger set of 8 Jaws 1/4" - 1-1/8" to suit >B< MaxiPro fittings
- Sizes include: 1/4", 3/8", 1/2", 5/8", 3/4", 7/8", 1", 1-1/8"
- 2x Stackable Carry Cases

Part No	Description
GM CXM8	Romax Compact Tool Set with Jaws



Romax Compact Tool Set c/w Battery & Charger (No Jaws)



- 19kN Press Tool
- 18V Battery
- Battery Charger
- Stackable Carry Case

Part No	Description
GMCXM0	Romax Compact Tool Set (No Jaws)

Conex MaxiPro 8 Jaw Set



- Rothenberger set of 8 Jaws 1/4" - 1-1/8" in a stackable carry case to suit MaxiPro fittings
- Sizes include: 1/4", 3/8", 1/2", 5/8", 3/4", 7/8", 1", 1-1/8"

Part No	Description	Size Range
GMCX8JS	Conex MaxiPro Set of 8 Jaws	1/4" - 1 1/8"

** MaxiPro Straight Couplers**



- Suitable for air-conditioning and refrigeration applications up to 48 bar

Part No	Description	Size	Qty/Pk
GMCXSC14	Straight Couplers	1/4"	pk5
GMCXSC38	Straight Couplers	3/8"	pk5
GMCXSC12	Straight Couplers	1/2"	pk5
GMCXSC58	Straight Couplers	5/8"	pk5
GMCXSC34	Straight Couplers	3/4"	pk2
GMCXSC78	Straight Couplers	7/8"	pk2
GMCXSC118	Straight Couplers	1-3/8"	pk2

** MaxiPro 45° Elbows**



- Suitable for air-conditioning and refrigeration applications up to 48 bar

Part No	Description	Size	Qty/Pk
GMCX45B14	45° Elbows	1/4"	pk3
GMCX45B38	45° Elbows	3/8"	pk3
GMCX45B12	45° Elbows	1/2"	pk3
GMCX45B58	45° Elbows	5/8"	pk3
GMCX45B34	45° Elbows	3/4"	pk3
GMCX45B78	45° Elbows	7/8"	pk3
GMCX45B118	45° Elbows	1-3/8"	pk2

** MaxiPro 90° Long Radius Elbows**



- Suitable for air-conditioning and refrigeration applications up to 48 bar

Part No	Description	Size	Qty/Pk
GMCX90B14	90° Long Radius Elbows	1/4"	pk5
GMCX90B38	90° Long Radius Elbows	3/8"	pk5
GMCX90B12	90° Long Radius Elbows	1/2"	pk3
GMCX90B58	90° Long Radius Elbows	5/8"	pk3
GMCX90B34	90° Long Radius Elbows	3/4"	pk3
GMCX90B78	90° Long Radius Elbows	7/8"	pk3
GMCX90B118	90° Long Radius Elbows	1-3/8"	pk2

** MaxiPro 90° Street Bends**



- Suitable for air-conditioning and refrigeration applications up to 48 bar

Part No	Description	Size	Qty/Pk
GMCXS90B38	90° Street Bends	3/8"	pk3
GMCXS90B12	90° Street Bends	1/2"	pk3
GMCXS90B58	90° Street Bends	5/8"	pk3
GMCXS90B34	90° Street Bends	3/4"	pk3
GMCXS90B78	90° Street Bends	7/8"	pk3
GMCXS90B118	90° Street Bends	1-3/8"	pk2

Rothenberger Compact Battery



- Patented "AIR COOLED" charging technology
- Processor-controlled charging management system
- Capacity indicator to control the charging level

Part No	Description
GMCXBAT	Rothenberger 18V Spare Battery

Conex MaxiPro Depth Gauge



- MaxiPro depth gauge with marker pen to confirm the proper insertion depth of the tubing into the fittings

Part No	Description
GMCXDG	Conex MaxiPro Depth Gauge & Marker

** MaxiPro Stop Ends**



- Suitable for air-conditioning and refrigeration applications up to 48 bar

Part No	Description	Size	Qty/Pk
GMCXSE14	Stop Ends	¼"	pk3
GMCXSE38	Stop Ends	¾"	pk3
GMCXSE12	Stop Ends	½"	pk3
GMCXSE58	Stop Ends	¾"	pk2
GMCXSE34	Stop Ends	¾"	pk2
GMCXSE78	Stop Ends	¾"	pk2
GMCXSE118	Stop Ends	1-½"	pk1

** MaxiPro Equal Tees**



- Suitable for air-conditioning and refrigeration applications up to 48 bar

Part No	Description	Size	Qty/Pk
GMCXET14	Equal Tees	¼"	pk3
GMCXET38	Equal Tees	¾"	pk3
GMCXET12	Equal Tees	½"	pk3
GMCXET58	Equal Tees	¾"	pk2
GMCXET34	Equal Tees	¾"	pk2
GMCXET78	Equal Tees	¾"	pk2
GMCXET118	Equal Tees	1-½"	pk1

** MaxiPro Reducing Couplers**



- Suitable for air-conditioning and refrigeration applications up to 48 bar

Part No	Description	Size	Qty/Pk
GMCXRC1238	Reducing Couplers	½"-¾"	pk2
GMCXRC5838	Reducing Couplers	¾"-¾"	pk2
GMCXRC5812	Reducing Couplers	¾"-¾"	pk2
GMCXRC3438	Reducing Couplers	¾"-¾"	pk2
GMCXRC3412	Reducing Couplers	¾"-¾"	pk2
GMCXRC3458	Reducing Couplers	¾"-¾"	pk2

Part No	Description	Size	Qty/Pk
GMCXRC7812	Reducing Couplers	¾"-¾"	pk2
GMCXRC7858	Reducing Couplers	¾"-¾"	pk2
GMCXRC7834	Reducing Couplers	¾"-¾"	pk2
GMCXRC11858	Reducing Couplers	1-¾"-¾"	pk1
GMCXRC11834	Reducing Couplers	1-¾"-¾"	pk1
GMCXRC11878	Reducing Couplers	1-¾"-¾"	pk1

** MaxiPro Fitting Reducers**



- Suitable for air-conditioning and refrigeration applications up to 48 bar
- For reducing fittings

Part No	Description	Size	Qty/Pk
GMCXFR3814	Fitting Reducers	¾"-¾"	pk2
GMCXFR1238	Fitting Reducers	½"-¾"	pk2
GMCXFR5838	Fitting Reducers	¾"-¾"	pk2
GMCXFR5812	Fitting Reducers	¾"-¾"	pk2
GMCXFR3412	Fitting Reducers	¾"-¾"	pk2
GMCXFR3458	Fitting Reducers	¾"-¾"	pk2
GMCXFR7812	Fitting Reducers	¾"-¾"	pk2

Part No	Description	Size	Qty/Pk
GMCXFR7858	Fitting Reducers	¾"-¾"	pk2
GMCXFR7834	Fitting Reducers	¾"-¾"	pk2
GMCXFR11812	Fitting Reducers	1-¾"-¾"	pk1
GMCXFR11858	Fitting Reducers	1-¾"-¾"	pk1
GMCXFR11834	Fitting Reducers	1-¾"-¾"	pk1
GMCXFR11878	Fitting Reducers	1-¾"-¾"	pk1

** MaxiPro Flare Adapters**



- Suitable for air-conditioning and refrigeration applications up to 48 bar

Part No	Description	Size	Qty/Pk
GMCXFA14	Flare Adapters	¼"	pk4
GMCXFA38	Flare Adapters	¾"	pk4
GMCXFA12	Flare Adapters	½"	pk2
GMCXFA58	Flare Adapters	¾"	pk2
GMCXFA34	Flare Adapters	¾"	pk2



Pressfit Liquid Line Filter Driers



- These have plain copper tails that can be crimped directly onto, making them press fit compatible

Part No	Description	Size	Qty/Pk
GMZL909	Liquid Line Filter Drier	3/8"	Each
GMZL910	Liquid Line Filter Drier	1/2"	Each

Pressfit Y Joints

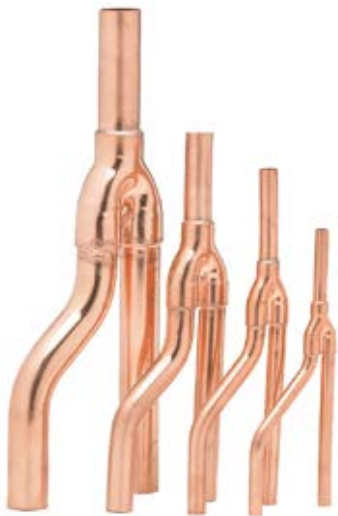

- Y Joints are part of our range of ancillary products for press fitting. These have plain copper tails which makes them press fit compatible

Part No	Description	Size	Qty/Pk
GMZL917	Pressfit Y Joints	3/8"	Each
GMZL918	Pressfit Y Joints	1/2"	Each
GMZL919	Pressfit Y Joints	3/4"	Each
GMZL920	Pressfit Y Joints	1"	Each
GMZL921	Pressfit Y Joints	1 1/4"	Each
GMZL922	Pressfit Y Joints	1 1/2"	Each
GMZL923	Pressfit Y Joints	1 3/4"	Each

Pressfit P Traps



- These have plain copper tails that can be crimped directly onto, making them press fit compatible

Part No	Description	Size	Qty/Pk
GMZL911	Pressfit P traps	1/2"	Each
GMZL912	Pressfit P traps	3/4"	Each
GMZL913	Pressfit P traps	1"	Each
GMZL914	Pressfit P traps	1 1/4"	Each
GMZL915	Pressfit P traps	1 1/2"	Each
GMZL916	Pressfit P traps	1 3/4"	Each

Pressfit Ball Valves c/w Schrader



- Ball Valves with Schraders are part of our range of ancillary products for press fitting. These have plain copper tails which makes them press fit compatible

Part No	Description	Size	Qty/Pk
GMZL924	Pressfit Ball Valves	1/2"	Each
GMZL925	Pressfit Ball Valves	3/4"	Each
GMZL926	Pressfit Ball Valves	1"	Each
GMZL927	Pressfit Ball Valves	1 1/4"	Each
GMZL928	Pressfit Ball Valves	1 1/2"	Each
GMZL929	Pressfit Ball Valves	1 3/4"	Each
GMZL930	Pressfit Ball Valves	2"	Each
GMZL931	Pressfit Ball Valves	2 1/2"	Each

Hybrid VRF

Contents

Hybrid Barrier Pipe	116
Hybrid Barrier Pipe Fittings	117 - 118
Hybrid Barrier Pipe Tools	119 - 120
Hybrid Barrier Pipe Push Fit Fittings	121
Hybrid Copper Press Fittings	122 - 123
Hybrid Compression Fittings	124 - 125
Hybrid Water Supply	126 - 127



Barrier Pipe - Straight Lengths

STÖRNCH

For Class 'O' Insulation See pages 78 & 80



- Multilayer pipe with aluminium
- WRAS approved
- 50 year life expectancy
- -40°C to +95°C working temperatures

Part No	Description	Size OD	Length
GMUP106	Straight Barrier Pipe	20mm Ø	5mt
GMUP102	Straight Barrier Pipe	25mm Ø	3.9mt
GMUP103	Straight Barrier Pipe	32mm Ø	3.9mt
GMUP104	Straight Barrier Pipe	40mm Ø	3.9mt

Coiled Barrier Pipes

STÖRNCH

For Class 'O' Insulation See pages 78 & 80



- Multilayer pipe with aluminium
- WRAS approved
- 50 year life expectancy
- -40°C to +95°C working temperatures

Part No	Description	Size OD	Length
GMUP107	Coiled Barrier Pipe	20mm Ø	100mt
GMUP100	Coiled Barrier Pipe	25mm Ø	50mt
GMUP105	Coiled Barrier Pipe	32mm Ø	50mt

Pre-Insulated Coiled Barrier Pipes & Tape

STÖRNCH



Part No	Description	Size OD	Wall Size
GMUP108	Pre-insulated Coiled Barrier Pipe	20mm Ø x 50mt	13mm
GMUP110	Pre-insulated Coiled Barrier Pipe	25mm Ø x 50mt	9mm
GMUP120	Pre-insulated Coiled Barrier Pipe	25mm Ø x 50mt	13mm
GMUP130	Pre-insulated Coiled Barrier Pipe	32mm Ø x 50mt	9mm
GMUP140	Pre-insulated Coiled Barrier Pipe	32mm Ø x 50mt	13mm
GMT2BLU	Blue PVC Tape	50mm x 33mt	

- WRAS approved Multilayer pipe with aluminium
- 50 year life expectancy
- -40°C to +95°C working temperatures
- Perfect for taping the Pre-Insulated Hybrid Barrier Pipe joints

Barrier Press Fit Straight Couplers

STÖRNCH



- For connecting Barrier Pipe together

Part No	Description	Size	Qty/Pk
GMUP4	Press Fit Straight Couplers	20mm Ø	pk 5
GMUP1	Press Fit Straight Couplers	25mm Ø	pk 5
GMUP2	Press Fit Straight Couplers	32mm Ø	pk 5
GMUP3	Press Fit Straight Couplers	40mm Ø	pk 5

Barrier Press Fit 90° Bends

STÖRNCH



- For connecting Barrier Pipe together

Part No	Description	Size	Qty/Pk
GMUP10	Press Fit 90° Bends	20mm Ø	pk 5
GMUP11	Press Fit 90° Bends	25mm Ø	pk 5
GMUP12	Press Fit 90° Bends	32mm Ø	pk 5
GMUP13	Press Fit 90° Bends	40mm Ø	pk 5

Barrier Press Fit Tees

- For connecting Barrier Pipe to Hybrid products with a 1/2" male thread
- Used in conjunction with AAV's, drain off cocks, pressure gauges and manual air vents
- GMPC254 required when using GMUP67



Part No	Description	Size	Qty/Pk
GMUP63	Press Fit Tees	20 x 20 x 1/2" FT	pk 5
GMUP65	Press Fit Tees	25 x 25 x 1/2" FT	pk 5
GMUP66	Press Fit Tees	32 x 32 x 1/2" FT	pk 5
GMUP67	Press Fit Tees	40 x 40 x 3/4" FT	pk 5
GMPC254	Brass Hex Bush	3/4" MT x 1/2" FT	each

Barrier Press Fit Equal Tee

STÖRNCH



- For connecting 25mm Ø Barrier Pipe together

Part No	Description	Size	Qty/Pk
GMUP31	Press Fit Equal Tees	25mm Ø	pk 10

Barrier Press Fit Male Adapters

STÖRNCH



- For connecting Barrier Pipe to Hybrid fan coil units

Part No	Description	Size	Qty/Pk
GMUP50	Press Fit Male Adapters	20mm Ø x 3/4"	pk 5
GMUP51	Press Fit Male Adapters	25mm Ø x 3/4"	pk 5
GMUP52	Press Fit Male Adapters	32mm Ø x 1-1/4"	pk 5
GMUP54	Press Fit Male Adapters	40mm Ø x 1-3/4"	pk 5

Barrier Press Fit Female Adapter

STÖRNCH



- For connecting 25mm Ø Barrier Pipe to fittings with 3/4" male threads

Part No	Description	Size	Qty/Pk
GMUP53	Press Fit Female Adapters	25mm Ø x 3/4"	pk 5

Copper Press Fit to Barrier Press Fit Adapters

- Used as a popular way to come off the HBC stubs
- Excellent for converting from 22mm copper pipe to barrier pipe
- We recommend using a GMCP2 22mm copper press fit coupling to connect this fitting to copper tube



STÖRNCH

Part No	Description	Size	Qty/Pk
GMUP79	Press Fit to Copper Press Adapter	20mm Ø x22mm Ø	Pk5
GMUP80	Press Fit to Copper Press Adapter	25mm Ø x22mm Ø	Pk5
GMUP81	Press Fit to Copper Press Adapter	32mm Ø x22mm Ø	Pk5

Copper Compression to Barrier Press Fit Adapters



STÖRNCH

- Used for connecting 22mm copper tube to barrier pipe
- It has a compression fitting one end, and a press fit at the other

Part No	Description	Size
GMHPF71	Copper to Barrier Press Fit / Compression Adapter	22mm to 25mm
GMHPF72	Copper to Barrier Press Fit / Compression Adapter	22mm to 32mm

Barrier Press Fit Reducers

STÖRNCH



- For connecting 32mm to 25mm barrier pipe (GMUP3225)
- For connecting 40mm to 25mm barrier pipe (GMUP4025)

Part No	Description	Size	Qty/Pk
GMUP3225	Press Fit Reducers	32mm Ø x25mm Ø	Pk5
GMUP4025	Press Fit Reducers	40mm Ø x25mm Ø	Pk5

Barrier Press Fit Lever Ball Valves



STÖRNCH

- Used for isolating Hybrid barrier press pipework

Part No	Description	Size
GMUP40	Barrier Press Fit Ball Valve	20mm Ø
GMUP41	Barrier Press Fit Lever Ball Valve	25mm Ø
GMUP42	Barrier Press Fit Lever Ball Valve	32mm Ø
GMUP43	Barrier Press Fit Lever Ball Valve	40mm Ø



Rothenberger Barrier Pipe Cutter



Part No	Description	Size
GMDFC2	Rothenberger Plastic Pipe Cutter	≤42mm

- 2 Stage pipe holder for cutting 0 - 20 & 20 - 42mm pipes
- Instant-release mechanism for minimal effort
- For precise cutting without deformation
- Direct & ratchet modes

Barrier Pipe Bevelling Tools



Part No	Description	Size
GMUP209	Barrier Pipe Bevelling Tool	20mm
GMUP210	Barrier Pipe Bevelling Tool	25mm
GMUP213	Barrier Pipe Bevelling Tool	32mm
GMUP214	Barrier Pipe Bevelling Tool	40mm

- To ensure a uniformly round bevel for easy connections
- Use with the handle provided or with a drill for speed

3 in 1 Barrier Pipe Bevelling Tools



STÖRNCH

- To ensure a uniformly round bevel for easy connections

Part No	Description	Size
GMUP216	3 in 1 Barrier Pipe Bevelling Tool	16/20/25mm
GMUP217	3 in 1 Barrier Pipe Bevelling Tool	20/25/32mm



Barrier Pipe Outside Bending Spring
STÖRNCH



- For bending 25mm Ø Barrier pipe externally
- Ensures an even bend without kinks

Part No	Description	Pipe Size
GMUP212	Outside Bending Spring	25mm Ø

Barrier Pipe Inside Bending Spring
STÖRNCH



- For bending 25mm Ø Barrier pipe internally
- Ensures the bore diameter is maintained when bending

Part No	Description	Pipe Size
GMUP211	Inside Bending Spring	25mm Ø

Rothenberger Barrier Pipe Bending Tool



- Ratchet action bending tool for Hybrid barrier pipe
- Supplied in carrying case c/w a set of bending inserts
- One-handed mechanism for easy use
- Ideal for producing 90° bends
- A high quality robust tool

Part No	Description	Size
GMUP215	Barrier Pipe Bending Tool	16/20/25 & 32mm

Push Fit Straight Coupler



- For connecting 25mm Ø Barrier pipe together

Part No	Description	Size	Qty/Pk
GMPPF1	Push Fit Straight Couplers	25mm Ø	Pk5

Push Fit 90° Bend



- For connecting 25mm Ø Barrier pipe together

Part No	Description	Size	Qty/Pk
GMPPF11	Push Fit 90° Bends	25mm Ø	Pk5

Push Fit Tees



- For connecting 25mm Ø Barrier pipe together
GMPPF31

- **GMPPF30**
- Female Iron Barrier Push-Fit Tee with 1/2" female threaded branch for connecting 25mm barrier pipe to hybrid products with 1/2" male threads.
- These tees are used in conjunction with automatic air vents, drain off cocks, and using a brass threaded bush, pressure gauges or manual air vents.

Part No	Description	Size	Qty/Pk
GMPPF30	Threaded Push Fit Tee	25mm x 25mm x 1/2"	Pk 4
GMPPF31	Push Fit Equal Tee	25mm Ø	Pk5

Push Fit Copper Adapter



- Often used as a way to come off the HBC stubs
- For converting 22mm Ø copper pipe to 25mm Ø Barrier pipe

Part No	Description	Size	Qty/Pk
GMPPF70	Push Fit Copper Adapters	25mm Ø x 22mm	Pk5

Push Fit Female Thread Adapter



- For connecting 25mm Ø Barrier pipe to fittings with a 3/4" male thread

Part No	Description	Size	Qty/Pk
GMPPF66	Push Fit Female Thread Adapters	25mm Ø x 3/4"	Pk5

Push Fit Male Thread Adapter



- For connecting 25mm Ø Barrier pipe to the Hybrid fan coil units

Part No	Description	Size	Qty/Pk
GMPPF65	Push Fit Male Thread Adapters	25mm Ø x 3/4"	Pk5

Plumbing Copper Tube - 3mt



- Half hard copper tube which conforms to BS EN 1057 R250 Table X

Part No	Description	Size	Length
GMPC2	Copper Tube	22mm x 0.9mm	3mt

Insulation Coil - Class '0'



- Armaflex class 0 insulation with built in anti-microbial and vapour barrier protection

Part No	Description	Pipe Size	Wall Size	Length
GMEU55	Insulation	22mm	9mm (3/8")	15mt
GMEU63	Insulation	22mm	13mm (1/2")	15mt

Insulation - Class '0'



- Armaflex class 0 insulation with built in anti-microbial and vapour barrier protection

Part No	Description	Pipe Size	Wall Size	Length
GMEU41	Insulation	22mm	9mm (3/8")	2mt
GMEU23	Insulation	22mm	13mm (1/2")	2mt

Copper Press Fit Straight Coupler



- For connecting 22mm copper pipe together

Part No	Description	Size	Qty/Pk
GMCP2	Press Fit Straight Couplers	22mm	pk10

Copper Press Fit 90° Bend



- For connecting 22mm copper pipe together

Part No	Description	Size	Qty/Pk
GMCP12	Press Fit 90° Bends	22mm	pk10

Copper Press Fit 45° Bend



- For connecting 22mm copper pipe together

Part No	Description	Size	Qty/Pk
GMCP22	Press Fit 45° Bends	22mm	pk10

Copper Press Fit Equal Tee



- For connecting 22mm copper pipe together

Part No	Description	Size	Qty/Pk
GMCP32	Press Fit Equal Tees	22mm	pk10

Copper Press Fit Reducing Tee



- Also used in conjunction with GMPC61 Long Stem Drain Off Cock

Part No	Description	Size	Qty/Pk
GMCP33	Press Fit Reducing Tees	22 x 22 x 15mm	pk10

Copper Press Fit Tee



- These tees are crimped on to 22mm plumbing copper
- The 1/2" female thread will accept AAV's, Drain Off Cocks, Pressure Gauges and Manual Air Vents (may need a GMPC253 Hex Bush)

Part No	Description	Size	Qty/Pk
GMCP62	Press Fit Tee	22 x 22 x 1/2" FT	pk10

Copper Press Fit Male Adapter



- For connecting 22mm copper pipe to the Hybrid fan coil unit

Part No	Description	Size	Qty/Pk
GMCP51	Press Fit Male Thread Adapter	22mm x 3/4"	pk10

Copper Press Fit Ball Valve



- Used for isolating the Hybrid pipework
- Supplied with a lever and 22mm copper press fit ends

Part No	Description	Size
GMCP42	Copper Press Fit Ball Valve	22mm

Copper Press DZR Brass Y Strainer



- Installed as part of the filling loop on a Hybrid system
- Provides filtration to prevent debris from getting into the system

Part No	Description	Size
GMCP71	Press Fit Y Strainer	22 mm

Threaded Drain Off Cock



- Install at least one drain off cock per fan coil unit
- Screws into a female iron tee (GMPC58)

Part No	Description	Size
GMPC62	Threaded Drain Off Cock	½"

Long Stem Drain Off Cock



- Usually crimped onto a GMCP33 22 x 22 x 15mm Reducing Tee

Part No	Description	Size
GMPC61	Long Stem Drain Off Cock	15mm

Air Admittance Valve



- For releasing air from the Hybrid system
- Install at least one AAV per fan coil unit at the highest points of the pipework

Part No	Description	Size
GMHYAV15	Air Admittance Valve	½"

Manual Air Vent & Hex Bush



- This is an air vent designed to manually remove any air trapped inside the wet side of the Hybrid system

Part No	Description	Size
GMPC275	Manual Air Vent	¼" BSP
GMPC253	Brass Hexagon Bush	½" M x ¼" F



Brass Y Strainer



- c/w 22mm compression ends
- Installed as part of the filling loop on the Hybrid system, and will provide filtration to help prevent debris from getting into the system

Part No	Description	Size
GMPC588	Brass Y Strainer	22mm

Brass Double Check Valve



- c/w 22mm compression ends
- This is a twin non-return valve which is installed as part the filling loop on the Hybrid system, and will prevent backflow to the water supply

Part No	Description	Size
GMPC305	Brass Double Check Valve	22 mm

¼ Turn Lever Ball Valve



- Nickel Plated
- WRAS Approved
- c/w red & blue handles

Part No	Description	Size
GMPC302	Lever Ball Valve	22mm

PTFE Thread Seal tape



- Ensures a safe, leak-free joint
- Wind onto the fitting in the direction of the thread
- For use with water systems only
- WRAS approved
- Conforms to BS7786:1995

Part No	Description	Size
GMT7	PTFE Tape (0.075mm thick)	12mt

Loctite 55 Sealing Cord



- Designed for the locking and sealing of metal and plastic pipes and fittings
- It needs no cure time and results in an immediate full pressure seal

Part No	Description	Size
GMT9	Loctite 55 Thread Sealing Cord	160mt



Expansion Tanks



- Expansion Tanks comply with EN13831 approved to PED 2014/68/EU
- Threaded connections
- Non-replaceable diaphragm, according to EN 13831 norm part 3, maximum operating temperature of 70 Degrees Celsius
- Durable epoxy coating
- Factory pre-pressurised gas chamber (Nitrogen)
- Requires a GMHYET1 Universal Mounting Bracket
- Requires a GMHYFLKIT Evolve EV-EVK Vessel Hose Kit 1

Part No	Description	Size
GMET8	Expansion Tank	8 Litre
GMET12	Expansion Tank	12 Litre
GMET18	Expansion Tank	18 Litre
GMET25	Expansion Tank	25 Litre

Universal Mounting Bracket



- For wall mounting Expansion Tanks from 8 litre to 25 litre

Part No	Description
GMHYET1	Universal Mounting Bracket for Expansion Tank

Expansion Tanks

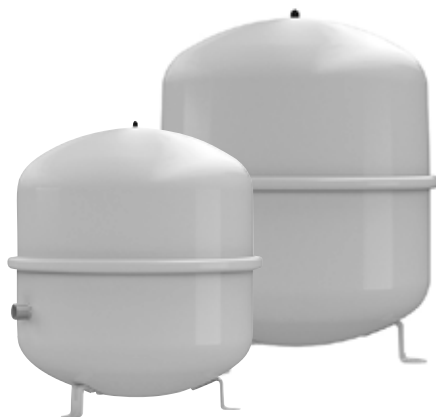

- Expansion Tanks comply with EN13831 approved to PED 2014/68/EU
- Threaded connections
- Non-replaceable diaphragm, according to EN 13831 norm part 3, maximum operating temperature of 70 Degrees Celsius
- Durable epoxy coating
- Factory pre-pressurised gas chamber (Nitrogen)
- Requires a GMHYFLKIT Evolve EV-EVK Vessel Hose Kit 1
- These three sizes come with feet therefore do not require a Universal Mounting Bracket

Part No	Description	Size
GMET35	Expansion Tank	35 Litre
GMET50	Expansion Tank	50 Litre
GMET80	Expansion Tank	80 Litre

Vessel Hose Kit



- Includes filling loop, pressure reducing valve and gauge
- Is used when fitting an expansion tank to pressurise the Hybrid circuit

Part No	Description
GMHYFLKIT	Vessel Hose Kit

Pressure Reducing Valve with Gauge



- Used for setting and maintaining the Hybrid system pressure
- c/w 22mm compression fittings with 15mm reducing inserts
- Suitable for horizontal and vertical mounting

Part No	Description	Size
GMPC590	Pressure Reducing Valve	22/15mm

0-10 Bar Pressure Gauge & Hex Bush



- Used to display the Hybrid system pressure
- Use the hexagon bush to connect pressure gauge to female iron tee

Part No	Description	Size
GMPC592	0-10 Bar Pressure Gauge	50mm/3/4"
GMPC253	Brass Hexagon Bush	1/2" M x 3/4" F



Condensate Removal

Contents

Overflow Drain Pipe & Fittings	129–130
Waste Drain Pipe & Fittings	131–132
Plastic & Rubber Reducers	133
Big Boss & Strap Boss Adapters	134
Stud Clips for Drain Pipe	135
Braided Condensate Hose & Fittings	136-137
Plumbing Copper Tube & End Feed Fittings	138-139
Plumbing Copper Solder Ring Fittings	140
Plumbing Copper Press Jaws & Fittings	141-142
Plumbing Copper Compression Fittings	143-144
Plumbing Copper Pipe Clips	145-146
Tank Pumps	147-149
Peristaltic Pumps	150
Elbow Pumps	151-153
Micro, Mini & Maxi Pumps	154-156
Rotary Diaphragm Pumps	157-158
Refrigeration Cabinet/Dairy Pumps	159
Condensate Drain Accessories	160

Overflow Pipe



- Solvent weld
- Manufactured from PVC-U
- Thick wall pipe

Part No	Description	Size	Length
GMDP1W	White Overflow Pipe	¾" (21.5mm)	2.9mt
GMDP1B	Black Overflow Pipe	¾" (21.5mm)	2.9mt

Overflow - Straight Couplings



- Solvent weld
- Manufactured from PVC-U

Part No	Description	Size	Length
GMDP2W-5	White Straight Couplings	¾" (21.5mm)	pk 5
GMDP2B-5	Black Straight Couplings	¾" (21.5mm)	pk 5

Overflow - 90° Elbows



- Solvent weld
- Manufactured from PVC-U

Part No	Description	Size	Length
GMDP3W-5	White 90° Elbows	¾" (21.5mm)	pk 5
GMDP3B-5	Black 90° Elbows	¾" (21.5mm)	pk 5

Overflow - 45° Bends



- Solvent weld
- Manufactured from PVC-U

Part No	Description	Size	Length
GMDP4W-5	White 45° Bends	¾" (21.5mm)	pk 5
GMDP4B-5	Black 45° Bends	¾" (21.5mm)	pk 5

Overflow - Equal Tees



- Solvent weld
- Manufactured from PVC-U

Part No	Description	Size	Length
GMDP5W-5	White Equal Tees	¾" (21.5mm)	pk 5
GMDP5B-5	Black Equal Tees	¾" (21.5mm)	pk 5

Overflow - Pipe Clips



- Manufactured from PVC-U
- Wall fixing

Part No	Description	Size	Length
GMDP7W-5	White Pipe Clips	¾" (21.5mm)	pk 5
GMDP7B-5	Black Pipe Clips	¾" (21.5mm)	pk 5

Overflow - Tank Connectors



- Solvent weld
- For connecting overflow pipe to tanks/drip trays

Part No	Description	Size	Qty/Pk
GMDP6W-5	White Tank Connectors	¾" (21.5mm)	pk 5
GMDP6B-5	Black Tank Connectors	¾" (21.5mm)	pk 5

Overflow - Push Fit End Cap



- Releasable push fit stop end cap
- Also designed for use on 22mm copper pipe

Part No	Description	Size	Qty/Pk
GMDP37	White Push Fit End Cap	¾" (21.5mm)	Each

Overflow - Waste Valve



- Waterless Trap (compression)
- For vertical installation only

Part No	Description	Size
GMDP44	Waste Valve	¾" (21.5mm)

Solvent Cement



- For use with solvent weld products
- Supplied with brush applicator
- Up to 55 joints per tub

STÖRNCH

Part No	Description	Size
GMDP35	Solvent Cement	250ml



Waste Drain Pipes



- Solvent weld
- Manufactured from ABS

Part No	Description	Size	Length
GMDP10W	White ABS Waste Pipe	1¼" (32mm)	3mt
GMDP20	White ABS Waste Pipe	1½" (40mm)	3mt
GMDP10B	Black ABS Waste Pipe	1¼" (32mm)	3mt
GMDP20B	Black ABS Waste Pipe	1½" (40mm)	3mt

Straight Couplings



- Solvent weld
- Manufactured from ABS

Part No	Description	Size	Qty/Pk
GMDP11W-5	White Straight Couplings	1¼" (32mm)	pk 5
GMDP21-5	White Straight Couplings	1½" (40mm)	pk 5
GMDP11B-5	Black Straight Couplings	1¼" (32mm)	pk 5
GMDP21B-5	Black Straight Couplings	1½" (40mm)	pk 5

Waste Drain - 90° Elbows



- Solvent weld
- Manufactured from ABS

Part No	Description	Size	Length
GMDP12W-5	White 90° Elbows	1¼" (32mm)	pk 5
GMDP22-5	White 90° Elbows	1½" (40mm)	pk 5
GMDP12B-5	Black 90° Elbows	1¼" (32mm)	pk 5
GMDP22B-5	Black 90° Elbows	1½" (40mm)	pk 5

Waste Drain - 90° Conversion Bend



- Black
- Pipe to fitting joint
- Solvent weld
- Manufactured from PVC

Part No	Description	Size	Qty Pk
GMDP512B-10	90° Conversion Bend	1¼" (32mm)	pk 10

Waste Drain - 45° Bends



- Solvent weld
- Manufactured from ABS

Part No	Description	Size	Length
GMDP13W-5	White 45° Bends	1¼" (32mm)	pk 5
GMDP23-5	White 45° Bends	1½" (40mm)	pk 5
GMDP13B-5	Black 45° Bends	1¼" (32mm)	pk 5
GMDP23B-5	Black 45° Bends	1½" (40mm)	pk 5

Waste Drain - 45° Conversion Bend



- Black
- Pipe to fitting joint
- Solvent weld
- Manufactured from PVC

Part No	Description	Size	Qty Pk
GMDP513B-10	45° Conversion Bends	1¼" (32mm)	pk 10

Waste Drain - Equal Tees



- Solvent weld
- Manufactured from ABS

Part No	Description	Size	Qty/Pk
GMDP14W-5	White Equal Tees	1½" (32mm)	pk 5
GMDP24-5	White Equal Tees	1½" (40mm)	pk 5
GMDP14B-5	Black Equal Tees	1½" (32mm)	pk 5
GMDP24B-5	Black Equal Tees	1½" (40mm)	pk 5

Waste Drain - Screwed Access Plugs



- Solvent weld
- Manufactured from ABS
- Connects to fittings

Part No	Description	Size	Qty/Pk
GMDP18W-5	White Access Plugs	1½" (32mm)	pk 5
GMDP30-5	White Access Plugs	1½" (40mm)	pk 5
GMDP18B-5	Black Access Plugs	1½" (32mm)	pk 5
GMDP30B-5	Black Access Plugs	1½" (40mm)	pk 5

Waste Drain - Pipe Clips



- Manufactured from ABS

Part No	Description	Size	Qty/Pk
GMDP19W-5	White Pipe Clips	1½" (32mm)	pk 5
GMDP31-5	White Pipe Clips	1½" (40mm)	pk 5
GMDP19B-5	Black Pipe Clips	1½" (32mm)	pk 5
GMDP31B-5	Black Pipe Clips	1½" (40mm)	pk 5

Hepv0 Waste Valves

Adapters Sold Separately



- Hygienic self-sealing valve designed to prohibit the escape of foul sewage smells into the air.
- Ideal for installation in confined spaces
- Won't dry out
- Prevents foul sewer air from entering a building

Part No	Description	Size
GMDP40	Hepv0 Waste Valve	1½"
GMDP41	Hepv0 Waste Valve	1½"

Waste Valve Compression Adapters



Part No	Description	Size
GMDP42	Hepworth BV3 Compression Adapter for Hepv0	1½"
GMDP45	McAlpine S31M Compression Adapter for Hepv0	1½"
GMDP46	McAlpine T31M Compression Adapter for Hepv0	1½"

- Adapters for Hepv0 Waste Valves

Plastic Reducers - White



Part No	Description	Size	Qty/Pk
GMDP9W-5	Plastic Reducers - White	1¼" - ¾"	pk 5
GMDP28-5	Plastic Reducers - White	1½" - 1¼"	pk 5
GMDP29-5	Plastic Reducers - White	1½" - ¾"	pk 5
GMDP58-5	Plastic Reducers - White	2" - 1¼"	pk 5

- Solvent weld
- For reducing fittings (pipe inserts into one end and a fitting in the other)

Plastic Reducers - Black



Part No	Description	Size	Qty/Pk
GMDP9B-5	Plastic Reducers - Black	1¼" - ¾"	pk 5
GMDP29B-5	Plastic Reducers - Black	1½" - ¾"	pk 5
GMDP28B-5	Plastic Reducers - Black	1½" - 1¼"	pk 5

- Solvent weld
- For reducing fittings (pipe inserts into one end and a fitting in the other)

Rubber Reducer - Black



- For reducing fittings (pipe inserts into one end and a fitting in the other)

Part No	Description	Size	Qty/Pk
GMDP8-5	Rubber Reducers - Black	1¼" - ¾"	pk 5



Big Boss Adapters



- Manufactured from ABS
- Big Boss Pipe Adapters make connecting a solvent weld pipe to a 110mm soil pipe a fast and easy procedure
- Clean and prepare the hole, removing any burrs to help with inserting the fitting

Part No	Description	Colour	Size	Use Hole Saw
GMDP60B	Big Boss Adapters	Black	¾" (21.5mm)	T25M (25mm)
GMDP61B	Big Boss Adapters	Black	1 ¼" (32mm)	T38M (38mm)
GMDP60G	Big Boss Adapters	Grey	¾" (21.5mm)	T25M (25mm)
GMDP61G	Big Boss Adapters	Grey	1 ¼" (32mm)	T38M (38mm)
GMDP62G	Big Boss Adapters	Grey	1 ½" (40mm)	T44M (44mm)
GMDP60W	Big Boss Adapters	White	¾" (21.5mm)	T25M (25mm)
GMDP61W	Big Boss Adapters	White	1 ¼" (32mm)	T38M (38mm)
GMDP62W	Big Boss Adapters	White	1 ½" (40mm)	T44M (44mm)

Strap Boss & Adapters



Adapters Sold Separately

- Easy clip connection to soil pipe
- Strap bosses are supplied without the rubber adapter – Choose required adapter from the options below

Part No	Description	Size	Colour	Use Hole Saw
GMDP15W	Strap Boss	4"	White	T54M (54mm)
GMDP15B	Strap Boss	4"	Black	T54M (54mm)
GMDP16	Strap Boss	6"	Grey	T54M (54mm)

Part No	Description	Size	Colour
GMDP38	Rubber Adapter	1 ¼"	Black
GMDP39	Rubber Adapter	1 ½"	Black

Stud Clips for ¾" Overflow Pipe



- Fast fixing direct to studding
- Simple to install, adjust and relocate
- Fits metric and imperial pipe sizes

Part No	Description	Colour	Size	Qty/Pk
GMRP4	M8 Stud Clip	Black	22mm (¾")	pk 10
GMRP16	M10 Stud Clip	Black	22mm (¾")	pk 10

Open Stud Clips for ¾" Overflow Pipe



- Twin application pipe clips enable your pipe to be either fixed to threaded rod or surface mounted
- Simply snap onto threaded rod & adjust up or down
- Also have a screw hole in the back to allow surface mounting

Part No	Description	Colour	Size	Qty/Pk
GMRP34	Open Stud Clip	Black	22mm (¾")	pk 10
GMRP4W	Open Stud Clip	White	22mm (¾")	pk 10

Stud Clips for 1-¼" & 1-½" Waste Pipe



- Fast fixing direct to studding
- Simple to install, adjust and relocate
- Fits metric and imperial pipe sizes

Part No	Description	Colour	Size	Qty/Pk
GMRP8	M8 Stud Clip	Black	35mm (1-¼")	pk 10
GMRP20	M10 Stud Clip	Black	35mm (1-¼")	pk 10
GMRP10	M8 Stud Clip	Black	42mm (1-½")	pk 10
GMRP22	M10 Stud Clip	Black	42mm (1-½")	pk 10

Open Stud Clips for 1-¼" Waste Pipe



- Twin application pipe clips enable your pipe to be either fixed to threaded rod or surface mounted
- Simply snap onto threaded rod & adjust up or down
- Also have a screw hole in the back to allow surface mounting

Part No	Description	Colour	Size	Qty/Pk
GMRP38	Open Stud Clip	Black	35mm (1-¼")	pk 10
GMRP8W	Open Stud Clip	White	35mm (1-¼")	pk 10

Clear Braided Hoses



- Tough, flexible and extremely durable under normal operating conditions
- Reinforced with high tensile polyester fibres
- Resistant to a wide range of chemicals

Part No	Description	Size	Roll Length
GMBH14C	Braided Hose - Clear	¼"	30mt
GMBH14C-100	Braided Hose - Clear	¼"	100mt
GMBH38C	Braided Hose - Clear	¾"	30mt
GMBH38C-100	Braided Hose - Clear	¾"	100mt

Part No	Description	Size	Roll Length
GMBH12	Braided Hose - Clear	½"	30mt
GMBH58	Braided Hose - Clear	¾"	30mt
GMBH34	Braided Hose - Clear	¾"	30mt
GMBH1	Braided Hose - Clear	1"	30mt

Black Braided Hoses



- Tough, flexible and extremely durable under normal operating conditions
- Reinforced with high tensile polyester fibres
- Resistant to a wide range of chemicals
- Black hose has no light penetration, limiting the build-up of mould/algae growth

Part No	Description	Size	Roll Length
GMBH14B	Braided Hose - Black	¼"	30mt
GMBH14B-100	Braided Hose - Black	¼"	100mt

Part No	Description	Size	Roll Length
GMBH38B	Braided Hose - Black	¾"	30mt
GMBH38B-100	Braided Hose - Black	¾"	100mt

Braided Hose Straight Connectors



- Used for joining two lengths of braided hose of the same diameter

Part No	Description	Size	Qty/Pk
GMHF3-5	Straight Connectors	¼"	pk 5
GMHF4-5	Straight Connectors	¾"	pk 5

Braided Hose Reducer & Tee



- Reducer for reducing from ¾" to ¼" braided hose

Part No	Description	Size	Qty/Pk
GMHF5-5	Reducers	¾" - ¼"	pk 5
GMHF8-5	Tees	¼"	pk 5

Non Return Valves



- Only allow the flow of water through in one direction, to prevent back-flow

Part No	Description	Size	Qty/Pk
GMHF1	Non Return Valve	¼"	pk 5
GMHF2	Non Return Valve	¾"	pk 5

Self Sealing Fittings



- The self-sealing fitting is used to connect 6 mm – 9.5 mm (1/4" – 3/8") hose to soil and vent pipes.
- Ø Drill size 11.5mm

Part No	Description	Size	Hole Size	Qty/Pk
GMP84-3	Self Sealing Fitting	¼" & ¾"	11.5mm	pk 3

Hose Clamps



- Used for clamping braided hose & other applications
- Worm drive

Part No	Description	Size	Qty/Pk
GMHF20-10	Hose Clamps	8 - 12mm	pk 10
GMHF21-10	Hose Clamps	10 - 16mm	pk 10
GMHF22-10	Hose Clamps	12 - 20mm	pk 10

Part No	Description	Size	Qty/Pk
GMHF23-10	Hose Clamps	16 - 25mm	pk 10
GMHF24-10	Hose Clamps	20 - 32mm	pk 10
GMHF25-10	Hose Clamps	25 - 40mm	pk 10

Braided Hose to Overflow Connector



- Handy option to connect 1/4" or 3/8" braided hose onto 3/4" (22mm) overflow pipe

Part No	Description	Qty/Pk
GMP88	Braided Hose to Overflow Connectors	pk 3

Flexible Drain Pipe



- Condensate removal hose in a continuous length
- Can fit directly onto some wall units

Part No	Description	Size	Roll/Length
GMDPF1	Flexible Drain Pipe	16mm	50mt

Plumbing Copper Tube

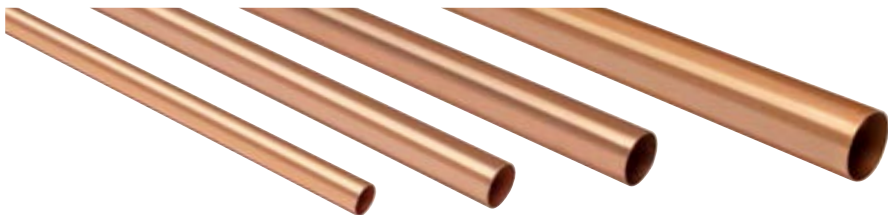

- Used for the removal of condensate
- Conforms to BS EN1057 R250/R290

Part No	Description	Size	Length
GMPC1	Plumbing Copper Tube	15mm x 0.7mm	3mt
GMPC2	Plumbing Copper Tube	22mm x 0.9mm	3mt

Part No	Description	Size	Length
GMPC3	Plumbing Copper Tube	28mm x 0.9mm	3mt
GMPC4	Plumbing Copper Tube	35mm x 1.2mm	3mt

End Feed Straight Couplers



- Used for joining plumbing copper tubing in condensate removal applications

Part No	Description	Size
GMPC5	End Feed Straight Coupler	15mm
GMPC6	End Feed Straight Coupler	22mm
GMPC7	End Feed Straight Coupler	28mm
GMPC8	End Feed Straight Coupler	35mm

End Feed 90° Elbows

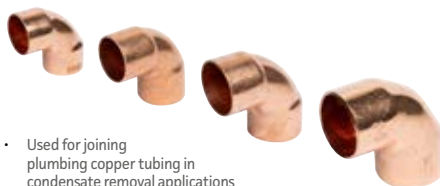

- Used for joining plumbing copper tubing in condensate removal applications

Part No	Description	Size
GMPC9	End Feed 90° Elbow	15mm
GMPC10	End Feed 90° Elbow	22mm
GMPC11	End Feed 90° Elbow	28mm
GMPC12	End Feed 90° Elbow	35mm

End Feed 45° Elbows



- Used for joining plumbing copper tubing in condensate removal applications

Part No	Description	Size
GMPC35	End Feed 45° Elbow	15mm
GMPC36	End Feed 45° Elbow	22mm
GMPC37	End Feed 45° Elbow	28mm
GMPC38	End Feed 45° Elbow	35mm

End Feed Equal Tees

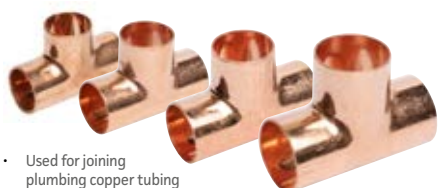

- Used for joining plumbing copper tubing in condensate removal applications

Part No	Description	Size
GMPC13	End Feed Equal Tee	15mm
GMPC14	End Feed Equal Tee	22mm
GMPC15	End Feed Equal Tee	28mm
GMPC16	End Feed Equal Tee	35mm

End Feed End Caps



- Used for capping plumbing copper tubing in condensate removal applications

Part No	Description	Size
GMPC322	End Feed End Cap	15mm
GMPC323	End Feed End Cap	22mm
GMPC324	End Feed End Cap	28mm
GMPC325	End Feed End Cap	35mm

End Feed Fitting Reducers

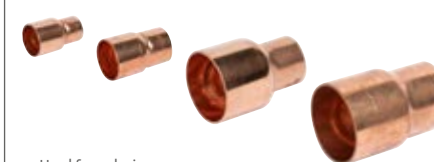

- Used for reducing plumbing copper tubing in condensate removal applications

Part No	Description	Size
GMPC17	End Feed Fitting Reducer	22mm - 15mm
GMPC18	End Feed Fitting Reducer	28mm - 22mm
GMPC86	End Feed Fitting Reducer	35mm - 22mm
GMPC19	End Feed Fitting Reducer	35mm - 28mm

Lead-Free Solder



- Used for fusing metals together
- Designed to produce joints quickly and cleanly

Part No	Description	Size	Weight
GMPC70	Lead-Free Solder	3.25mm	500g

La-Co Flux & Brush



- Water-soluble paste - won't leave residue in water piping
- Non-acid, non-toxic & lead-free
- Cleans pipe on application, allowing solder to run more smoothly

Part No	Description	Weight
GMPC71	La-Co Flux	125g
GMPT73	Flux Brush	

Wire Wool



- Made up of fine, flexible steel filaments
- Used for cleaning tube and joints

Part No	Description	Size
GMPC69	Wire Wool	200g

PTFE Tape & Thread Sealing Cord



- WRAS approved
- Conforms to BS7786:1995
- For use with water only
- Threaded pipe sealing cord
- Fast, easy and secure

Part No	Description	Size
GMT7	PTFE Tape	12mm x 0.075mm x 12mt
GMT9	Loctite 55 Sealing Cord	160mt

Solder Ring Straight Couplers



- Pre-soldered capillary connectors, used in condensate removal applications

Part No	Description	Size
GMPC102	Solder Ring Straight Coupler	15mm
GMPC103	Solder Ring Straight Coupler	22mm
GMPC104	Solder Ring Straight Coupler	28mm
GMPC105	Solder Ring Straight Coupler	35mm

Solder Ring 90° Elbows

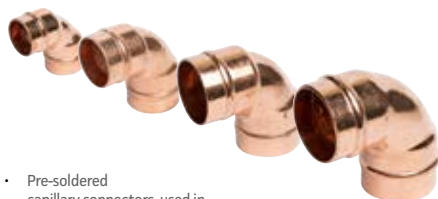

- Pre-soldered capillary connectors, used in condensate removal applications

Part No	Description	Size
GMPC112	Solder Ring 90° Elbow	15mm
GMPC113	Solder Ring 90° Elbow	22mm
GMPC114	Solder Ring 90° Elbow	28mm
GMPC115	Solder Ring 90° Elbow	35mm

Solder Ring 45° Elbows

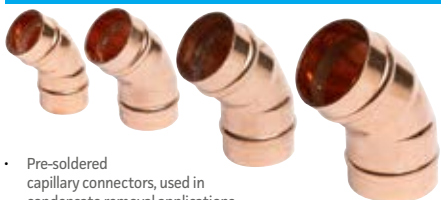

- Pre-soldered capillary connectors, used in condensate removal applications

Part No	Description	Size
GMPC132	Solder Ring 45° Elbow	15mm
GMPC133	Solder Ring 45° Elbow	22mm
GMPC134	Solder Ring 45° Elbow	28mm
GMPC135	Solder Ring 45° Elbow	35mm

Solder Ring Equal Tees



- Pre-soldered capillary connectors, used in condensate removal applications

Part No	Description	Size
GMPC142	Solder Ring Equal Tee	15mm
GMPC143	Solder Ring Equal Tee	22mm
GMPC144	Solder Ring Equal Tee	28mm
GMPC145	Solder Ring Equal Tee	35mm



Copper M Pressfit Jaws



- For copper pressfit system
- 15kN Jaws compatible with 15kN press tool
- 19kN Jaws compatible with the 19kN RLS & Rothenberger press tools
- M-Profile

Part No	Description	Capacity	Size
GMCPJ16	Copper Pressfit Jaw	15kN	15mm
GMCPJ23	Copper Pressfit Jaw	15kN	22mm
GMCPJ29	Copper Pressfit Jaw	15kN	28mm
GMCPJ15	Copper Pressfit Jaw	19kN	15mm
GMCPJ22	Copper Pressfit Jaw	19kN	22mm
GMCPJ28	Copper Pressfit Jaw	19kN	28mm
GMCPJ35	Copper Pressfit Jaw	19kN	35mm

Copper Press Straight Couplers



- Conforms with BS EN 1057
- Fitted with EPDM seals (O-rings)
- WRAS Approved
- Max working pressure: 16 bar (PN16)
- Working temperature range: -10°C to 110°C
- Press profile: M

Part No	Description	Size	Qty/Pk
GMCP1	Copper Press Straight Coupler	15mm	pk 10
GMCP2	Copper Press Straight Coupler	22mm	pk 10
GMCP3	Copper Press Straight Coupler	28mm	pk 10
GMCP4	Copper Press Straight Coupler	35mm	pk 4

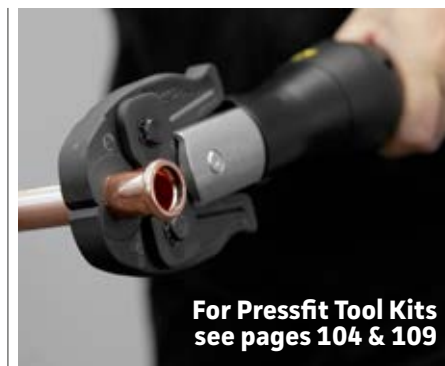

Copper Press 90° Bends



- Conforms with BS EN 1057
- Fitted with EPDM seals (O-rings)
- WRAS Approved
- Max working pressure: 16 bar (PN16)
- Working temperature range: -10°C to 110°C
- Press profile: M

Part No	Description	Size	Qty/Pk
GMCP11	Copper Press 90° Bend	15mm	pk 10
GMCP12	Copper Press 90° Bend	22mm	pk 10
GMCP13	Copper Press 90° Bend	28mm	pk 5
GMCP14	Copper Press 90° Bend	35mm	pk 2

Copper Press 45° Bends



- Conforms with BS EN 1057
- Fitted with EPDM seals (O-rings)
- WRAS Approved
- Max working pressure: 16 bar (PN16)
- Working temperature range: -10°C to 110°C
- Press profile: M

Part No	Description	Size	Qty/Pk
GMCP21	Copper Press 45° Bend	15mm	pk 10
GMCP22	Copper Press 45° Bend	22mm	pk 10
GMCP23	Copper Press 45° Bend	28mm	pk 5
GMCP24	Copper Press 45° Bend	35mm	pk 4

Copper Press Equal Tees

- Conforms with BS EN 1057
- Fitted with EPDM seals (O-rings)
- WRAS Approved
- Max working pressure: 16 bar (PN16)
- Working temperature range: -10°C to 110°C
- Press profile: M



Part No	Description	Size	Qty/Pk
GMCP31	Copper Press Equal Tees	15mm	pk 10
GMCP32	Copper Press Equal Tees	22mm	pk 10
GMCP34	Copper Press Equal Tees	28mm	pk 4
GMCP35	Copper Press Equal Tees	35mm	pk 2

Copper Press Female Threaded Tee

- For providing a ½" BSP female branch off 22mm plumbing copper
- Conforms with BS EN 1057
- Fitted with EPDM seals (O-rings)
- WRAS Approved
- Max working pressure: 16 bar (PN16)
- Working temperature range: -10°C to 110°C
- Press profile: M



Part No	Description	Size	Qty/Pk
GMCP62	Copper Press Fit Tee	22 x 22 x ½" FT	pk 10

Copper Press Reducing Tees

- Conforms with BS EN 1057
- Fitted with EPDM seals (O-rings)
- WRAS Approved
- Max working pressure: 16 bar (PN16)
- Working temperature range: -10°C to 110°C
- Press profile: M



Part No	Description	Size	Qty/Pk
GMCP33	Copper Press Reducing Tees	22 x 22 x 15mm	pk 10

Copper Press Fitting Reducers

- Conforms with BS EN 1057
- Fitted with EPDM seals (O-rings)
- WRAS Approved
- Max working pressure: 16 bar (PN16)
- Working temperature range: -10°C to 110°C
- Press profile: M



Part No	Description	Size	Qty/Pk
GMCP50	Copper Press Fitting Reducer	22 - 15mm	pk 10
GMCP49	Copper Press Fitting Reducer	28 - 22mm	pk 10
GMCP52	Copper Press Fitting Reducer	35 - 28mm	pk 4

Copper Press Ball Valves

- Supplied with a lever and copper press fit ends for a super fast leak free connection
- Conforms with BS EN 1057
- Fitted with EPDM seals (O-rings)
- WRAS Approved
- Max working pressure: 16 bar (PN16)
- Working temperature range: -10°C to 110°C
- Press profile: M



Part No	Description	Size
GMCP41	Copper Press Ball Valve	15mm
GMCP42	Copper Press Ball Valve	22mm
GMCP43	Copper Press Ball Valve	28mm
GMCP44	Copper Press Ball Valve	35mm

Copper Press Male Threaded Adapter

- For connecting 22mm plumbing copper tubing to ¾" BSP female threads
- Conforms with BS EN 1057
- Fitted with EPDM seals (O-rings)
- WRAS Approved
- Max working pressure: 16 bar (PN16)
- Working temperature range: -10°C to 110°C
- Press profile: M



Part No	Description	Size	Qty/Pk
GMCP51	Copper Press Male Thread Adapter	22mm x ¾"	pk10

Brass Compression Straight Couplers



- Used for joining plumbing copper tubing in condensate removal applications

Part No	Description	Size
GMPC40	Brass Compression Straight Coupler	15mm
GMPC41	Brass Compression Straight Coupler	22mm
GMPC42	Brass Compression Straight Coupler	28mm
GMPC43	Brass Compression Straight Coupler	35mm

Brass Compression 90° Elbows



- Used for joining plumbing copper tubing in condensate removal applications

Part No	Description	Size
GMPC44	Brass Compression 90° Elbow	15mm
GMPC45	Brass Compression 90° Elbow	22mm
GMPC46	Brass Compression 90° Elbow	28mm
GMPC47	Brass Compression 90° Elbow	35mm

Brass Compression Equal Tees



- Used for joining plumbing copper tubing in condensate removal applications

Part No	Description	Size
GMPC48	Brass Compression Equal Tee	15mm
GMPC49	Brass Compression Equal Tee	22mm
GMPC50	Brass Compression Equal Tee	28mm
GMPC51	Brass Compression Equal Tee	35mm

Brass Compression Reducers



- Used for joining plumbing copper tubing in condensate removal applications

Part No	Description	Size
GMPC56	Brass Compression Reducer	22mm - 15mm
GMPC57	Brass Compression Reducer	28mm - 22mm
GMPC59	Brass Compression Reducer	35mm - 28mm

Brass Compression Female Iron Couplers



- Used for joining plumbing copper tubing in condensate removal applications

Part No	Description	Size
GMPC214	Brass Compression Female Iron Coupler	22mm x ¾" FT

Brass Compression Male Iron Couplers



- Used for joining plumbing copper tubing in condensate removal applications

Part No	Description	Size
GMPC222	Brass Compression Male Iron Coupler	15mm x ¾" MT
GMPC225	Brass Compression Male Iron Coupler	22mm x ¾" MT
GMPC228	Brass Compression Male Iron Coupler	28mm x 1" MT

Brass Compression Female Iron Elbow



- For connecting 22mm plumbing copper tubing to 1" threads

Part No	Description	Size
GMPC237	Brass Compression Female Iron Elbow	22mm x 1" FT

Brass Compression End Caps



- Use for capping plumbing copper tubing in condensate removal applications.

Part No	Description	Size
GMPC52	Brass Compression End Caps	15mm
GMPC53	Brass Compression End Caps	22mm
GMPC54	Brass Compression End Caps	28mm
GMPC55	Brass Compression End Caps	35mm

Brass Compression Female Iron Tee



- For providing a ½" BSP female branch off 22mm plumbing copper

Part No	Description	Size
GMPC58	Female Iron Tee	22 x 22mm x ½"

Brass Hexagon Bushes



- Used to reduce BSP threaded fittings

Part No	Description	Size
GMPC253	Brass Hexagon Bush	½" M x ¼" F
GMPC254	Brass Hexagon Bush	¾" M x ½" F

¼ Turn Lever Ball Valve



- ¼ turn lever
- WRAS approved
- BS EN331
- Nickel plated
- c/w red & blue handles

Part No	Description	Size
GMPC300	¼ Turn Lever Ball Valve	15mm
GMPC302	¼ Turn Lever Ball Valve	22mm
GMPC494	¼ Turn Lever Ball Valve	28mm
GMPC496	¼ Turn Lever Ball Valve (Blue Handle Only)	35mm

Chrome Isolation Valves & Olives



- For use in compression fittings

- Light pattern
- Shut-off valve with compression ends

Part No	Description	Size
GMPC24	Chrome Isolation Valve	15mm
GMPC25	Chrome Isolation Valve	22mm
GMPC256	Brass Olive	15mm
GMPC257	Brass Olive	22mm

Brass Pipe Rings



Part No	Description	Size	Qty/Pk
GMJ14A	M10 Single Brass Pipe Ring	15mm	Each
GMJ15	M10 Single Brass Pipe Ring	22mm	Each
GMJ16	M10 Single Brass Pipe Ring	28mm	Each
GMJ17	M10 Single Brass Pipe Ring	35mm	Each
GMJ18	M10 Single Brass Pipe Ring	42mm	Each

- Used for pipe installation/management
- Can be used in conjunction with M10 male backplates
- Available to suit common pipe sizes, from 15mm up to 42mm

Male Brass Backplate



- Can be used in conjunction with brass pipe rings to secure copper pipework to walls and ceilings
- Available in M10

Part No	Description	Size	Qty/Pk
GMJ13A	Male Brass Backplate	M10	Each

Female Brass Backplate



- Can be used in conjunction with M10 studding

Part No	Description	Size	Qty/Pk
GMJ11A	Female Brass Backplate	M10	Each

Pressed Pipe Clips



- Used for pipe installation/management
- Available to suit common pipe sizes, from 15mm up to 28mm

Part No	Description	Size	Qty/Pk
GMPC30	Pressed Pipe Clip	15mm	Each
GMPC31	Pressed Pipe Clip	22mm	Each
GMPC32	Pressed Pipe Clip	28mm	Each



Rubber Lined Pipe Clamps



- All clips are dual tapped to take M8 and M10 studding
- Rubber lining ideal for both insulation and noise control
- *GMJ4 suits 1-1/4" drain

Part No	Description	Size	Qty/Pk
GMJ1-50	Rubber Lined Pipe Clamp	15mm	pk 50
GMJ2-50	Rubber Lined Pipe Clamp	22mm	pk 50
GMJ3-50	Rubber Lined Pipe Clamp	28mm	pk 50
GMJ4-50*	Rubber Lined Pipe Clamp	35mm	pk 50

Part No	Description	Size	Qty/Pk
GMJ5-50	Rubber Lined Pipe Clamp	42mm	pk 50
GMJ13B-50	Rubber Lined Pipe Clamp	48 - 53mm	pk 50
GMJ6-50	Rubber Lined Pipe Clamp	54mm	pk 50
GMJ14B	Rubber Lined Pipe Clamp	58 - 64mm	Each
GMJ11B	Rubber Lined Pipe Clamp	108mm	Each

Munson Base

STÖRNCH



- Used to attach studding to a flat surface
- Dual tapped to accept M8 or M10 threads
- Zinc plated (BZP)

Part No	Description	Qty/Pk
GMJ12A-25	Dual Tapped Munson Bases BZP	pk 25

Talon Pipe Clips



- Offering a secure, 360° fixing for pipework
- High quality polypropylene hinged clip

Part No	Description	Size	Qty/Pk
GMTAL15S	Talon Pipe Clips	15mm	pk 100
GMTAL22S	Talon Pipe Clips	22mm	pk 100
GMTAL28S	Talon Pipe Clips	28mm	pk 50

STÖRNCH High Flow Tank Pump

STÖRNCH

- The STÖRNCH high flow tank pump is designed to collect condensate & discharge it up to recommended maximum 5 metres head
- Plug & Play

Key Features

- 4 inlets
- Wall mounts
- Quick release reservoir
- Retaining clip for outlet barb
- Plug & Play



Part No	Description	Model	Tank Size	Max Head	Max Flow	Hose Connection	dBa
GMP95	STÖRNCH Tank Pump	High Flow	1.7ltr	5mt	300ltr/hour	1/4" & 3/8"	49 dBa



Aspen Max Hi-Flow Tank Pump



- The Max Hi-Flow tank pump carries on the Aspen Pumps tradition of build quality & high performance

Key Features

- 4 inlets
- Built-in spirit level
- Wall mounts
- Rod mounts
- Quick release reservoir
- Retaining clip for outlet barb
- Plug & Play



Part No	Description	Model	Tank Size	Max Head	Max Flow	Hose Connection	dBa
GMP20	Aspen Tank Pump	Max Hi-Flow	1.7ltr	5mt	550ltr/hour	1/4" & 3/8"	44 dBa

Aspen Mini Tank Pump



- The 'Mini' tank pump can be wall mounted, floor mounted, in-pan or suspended on M8/ M10 threaded rod
- Using piston technology, this is a compact, powerful and multi-functional tank pump

Part No	Description	Model	Tank Size	Max Head	Max Flow	Hose Connection	dBa
GMP49	Aspen Tank Pump	Mini Tank	0.24ltr	15mt	35ltr/hour	¼" & ⅜"	35 dBa

Aspen Hi-Lift Tank Pump



- The world's only peristaltic tank pump
- Offers high head and reliability
- Built-in spirit level
- Easy access to clean the tray
- Easy fit & maintenance

Part No	Description	Model	Tank Size	Max Head	Max Flow	Hose Connection	dBa
GMP8	Aspen Peristaltic Tank Pump	Hi-Lift	1ltr	12mt	11ltr/hour	¼"	51 dBa
GMP9	Aspen Peristaltic Tank Pump	Hi-Lift	2ltr	12mt	11ltr/hour	¼"	51 dBa

Sauermann Tank Pump Si83



- Float design resistant to fouling
- Tolerates acidic condensates (pH>2.5) produced by gas-condensing boilers
- No need to remove pump from installation to clean
- Removable anti-return valve
- Quick & easy maintenance
- Maintenance function in the Smartphone App (available for both iOS and Android devices)
- Floor mounting, wall mounting and suspension ceiling options
- 5 inlets - 4 on top, 1 on the side for low condensate entry

Part No	Description	Model	Tank Size	Max Head	Max Flow	Hose Connection	dBa
GMP65	Sauermann Tank Pump	Si83	2.0ltr	5.4mt	700ltr/hour	¾"	45 dBa

Aspen Heavy Duty Tank Pump



- With an impressive flow rate, this robust and reliable 'Heavy Duty' pump is perfect for the rapid removal of large quantities of condensate water

Part No	Description	Model	Tank Size	Max Head	Max Flow	Hose Connection	dBa
GMP10	Aspen Tank Pump	Heavy Duty	4ltr	6mt	900ltr/hour	¾"	60 dBa
GMP11	Aspen Tank Pump	Heavy Duty	4ltr	9mt	1070ltr/hour	¾"	64 dBa

Aspen Hot Water Tank Pump



- Built of heat resistant cyclopy, this pump is designed to handle high water temperatures of 100°C water
- Outstanding water flow rates

Part No	Description	Model	Tank Size	Max Head	Max Flow	Hose Connection	dBa
GMP12	Aspen Tank Pump	Hot Water	4ltr	7mt	900ltr/hour	¾"	60 dBa

Little Giant Tank Pump - 1.9 Ltr



- Ideal for cassettes and ducted units
- Easy to install and low maintenance
- High durability and reliability
- Supplied with both ¾" & ⅜" check valve outlets

Part No	Description	Model	Tank Size	Max Head	Max Flow	Hose Connection	dBa
GMP30	Little Giant Tank Pump	VCMA20S	1.9ltr	4.3mt	300ltr/hour	¼" & ⅜"	58 dBa

Aspen Peristaltic Standard Sensor

- Operated by an air conditioning cooling signal, the 'Standard' peristaltic sets the standard for reliability
- Can run dry
- Can pump contaminated water
- c/w 2mt plug & play lead



Part No	Description	Model	Max Head	Max Lift	Max Flow	Hose Connection	dBa
GMP1	Aspen Peristaltic Pump	Standard Sensor	12mt	3mt	6.5ltr/hour	¼"	47 dBa

Aspen Universal Peristaltic Temperature Sensor

- The top selling 'Universal' is operated by two air temperature sensors. The peristaltic rotary movement creates a continuous pressure meaning the pump can be sited 3mt away from the source with no effect in performance
- Can run dry
- Can pump contaminated water
- c/w 3mt plug & play lead/sensor



Part No	Description	Model	Max Head	Max Lift	Max Flow	Hose Connection	dBa
GMP2	Aspen Peristaltic Pump	Universal T° Sensor	12mt	3mt	6.5tr/hour	¼"	47 dBa

Aspen MK4 Peristaltic Water Sensor

- The 'MK4' peristaltic is operated using two water sensors. The lower sensor comes into contact with water, the heat conductivity from that sensor provides a temperature difference between the second - energising the pump
- Can run dry
- Can pump contaminated water
- c/w 2mt plug & play lead



Part No	Description	Model	Max Head	Max Lift	Max Flow	Hose Connection	dBa
GMP3	Aspen Peristaltic Pump	MK4 Water Sensor	12mt	3mt	6.5ltr/hour	¼"	47 dBa

Aspen Peristaltic Mechanical Float

- Bringing mini pump and peristaltic pump technology together. Simply position the remote reservoir (float switch) in the condensate tray or fix to the drain pipe connection (depending on the chosen reservoir)
- c/w submersible secondary reservoir
- c/w 2mt plug & play lead



Part No	Description	Model	Max Head	Max Lift	Max Flow	Hose Connection	dBa
GMP4	Aspen Peristaltic Pump	Mechanical Float	12mt	3mt	6.5ltr/hour	¼"	47 dBa

Aspen Mini Lime Elbow Pump c/w Trunking



- c/w anti-vibration damper and built in sound absorbing materials
- Quick release reservoir
- 70mm Speediduct trunking

- LED operation feedback
- Perfect for offices and meeting rooms
- Can install left or right hand

Part No	Description	Model	Trunking	Max Head	Max Flow	Hose Connection	dBa
GMP21S	Aspen Elbow Pump	Mini Lime Silent+	Speediduct - Ivory	10mt	12ltr/hour	¼"	20 dBa
GMP21W	Aspen Elbow Pump	Mini Lime Silent+	Speediduct - White	10mt	12ltr/hour	¼"	20 dBa

Aspen Maxi Lime Elbow Pump c/w Ivory Trunking



- Designed for larger units and humid environments
- The Maxi Lime elbow pump gives you superb power when needed
- Can install left or right hand
- 70mm Speediduct trunking

Part No	Description	Model	Trunking	Max Head	Max Flow	Hose Connection	dBa
GMP24	Aspen Elbow Pump	Maxi Lime	Speediduct - Ivory	15mt	35ltr/hour	¼"	35 dBa

Sauermann Delta Pack Elbow Pump c/w Trunking



- Complete kit intended for wall mounted air conditioning units
- Quiet in operation
- Sauermann 80x60mm white
- Easily opened by hand
- Includes the latest piston pump technology

Part No	Description	Model	Trunking	Max Head	Max Flow	Hose Connection	dBa
GMP75	Sauermann Elbow Pump	Delta Pack	Sauermann	14mt	20ltr/hour	¼"	22 dBa

Whispa-Q-Trunk Pump

The WHISPA-Q-TRUNK is an industry first stand-alone pump in trunking for the future. Designed to provide ultra-quiet running utilising the new DC DIAPHRAGM PUMP TECHNOLOGY along with a stylish sleek ultra-cool design. This new pump offers easy installation and hassle free maintenance, whilst dramatically cutting running costs. A true silent, gentle giant that doesn't cost the earth.

- Features:
- Innovative design
- Ultra quiet
- Low power consumption
- Added space for pipe and hose
- Alarm warning red LED



Part No	Description	Model	Trunking	Max Head	Max Flow	Hose Connection	dBa
GMP68	Elbow Pump	Whispa-Q-Trunk	Whispa-Q Trunking	8mt	33ltr/hour	¼"	21 dBa

Blue Diamond MicroBlue Pump c/w Trunking

BLUEDIAMOND
CONDENSATE REMOVAL PUMPS

- The MicroBlue™ is the only ductless pump on the market that can remove sediment/ debris with no need of filters or regular servicing intervals
- Smooth flow rate from the MicroBlue™ eliminates the necessity for any pulsating free tubing and silencing devices
- Can be mounted in any orientation up to 5m away from the air conditioning unit operating both wet and dry continuously
- Silent operation
- 70mm Speediduct trunking



Part No	Description	Model	Trunking	Max Head	Max Lift	Max Flow	Hose Connection	dBa
GMP90	Blue Diamond Pump	Micro Blue	SpeediDuct -White	5mt	2mt	5ltr/hour	¼"	17 dBa
GMP94	Blue Diamond Pump	Micro Blue	SpeediDuct -Ivory	5mt	2mt	5ltr/hour	¼"	17 dBa

Aspen Mini Lime Elbow Pump

- Pump only version of the Silent+ Mini Lime
- c/w anti-vibration damper and built in sound absorbing materials
- Quick release reservoir
- LED operation feedback
- Can install left or right hand



Part No	Description	Model	Trunking	Max Head	Max Flow	Hose Connection	dBa
GMP225	Aspen Elbow Pump	Mini Lime Silent+	Without Trunking	10mt	12ltr/hour	¼"	20 dBa

Aspen Maxi Lime Elbow Pump

- Designed for larger units and humid environments
- Gives you superior power when you need it
- Pump only version of the Maxi Lime
- Can install left or right hand



Part No	Description	Model	Trunking	Max Head	Max Flow	Hose Connection	dBa
GMP50	Aspen Elbow Pump	Maxi Lime	Without Trunking	15mt	35ltr/hour	¼"	35 dBa

Sauermann Si10 Universal Mini Elbow Pump

- Replacement for Delta pumps
- Improved design to ensure a reduced sound level and ease of maintenance
- The distinctive shape of the Si-10 pump allows its use in both new installations and refurbishments



Part No	Description	Model	Trunking	Max Head	Max Flow	Hose Connection	dBa
GMP71	Sauermann Mini Elbow Pump	Si10	Without Trunking	14mt	20ltr/hour	¼"	22 dBa

Aspen Micro-V i4 Intelligent Pump



- The Micro-V pump which has no breather tube, fits into the smallest of spaces. On-demand operation and floatless technology delivers silent running and a longer pump life
- No breather tube
- Unrivalled controlled soft start function for truly quiet running and prolonged pump life
- Small multi orientation sensor with visual pump status diagnostics
- Perfect for installing directly inside the unit

Part No	Description	Model	Max Head	Max Lift	Max Flow	Hose Connection	dBa
GMP60	Aspen Mini Pump	Micro-V i4 (Intelligent)	10mt	2mt	14.5ltr/hour	¼"	19 dBa

Blue Diamond Micro Blue Pump c/w Reservoir Sensor



- The BLUEDIAMOND® MICROBLUE® utilises the ground-breaking patented GYROK™ technology.
- The pump is totally self-priming, and offers 5ltr/hour flow even in high lift and high head applications
- The MICROBLUE® is dual voltage
- Thanks to the silent nature of the pump, running wet or dry, combined with unmatched thermistor level sensing technology, eliminates the risk of stuck float switches.

Part No	Description	Model	Max Head	Max Lift	Max Flow	Hose Connection	dBa
GMP42	Blue Diamond Pump	Micro Blue	5mt	2mt	5ltr/hour	¼"	17 dBa

Aspen Mini Blanc Pump



- The 'ultra quick fit' Mini Blanc is designed to be fitted beneath high wall indoor units and offers easy access for future maintenance

Part No	Description	Model	Max Head	Tank Size	Max Flow	Hose Connection	dBa
GMP26	Aspen Mini Pump	Mini Blanc	10mt	0.24ltr	12ltr/hour	¼"	21 dBa

Pumpkin 10 Mini Pump

- Float operated pump complete with slim design and low noise level
- Suitable for 80mm trunking
- For air conditioning systems up to 10kW
- Fits perfectly in either wall mounted mini split or ceiling mounted air conditioners
- The small transparent float sensor can easily be connected to the drain hose using the attached inlet hose



Part No	Description	Max Head	Max Lift	Max Flow	Hose Connection
GMP53	Pumpkin 10 Mini Pump	10mt	1.5mt	9ltr/hour	¼"

Galaxy Electronic Smart Pump

- Compact electronic sensor can be mounted in most positions making it the most versatile sensor on the market
- With a quiet soft start and switch-off, the intelligent electronic control delivers quiet and unobtrusive pump operation
- All electronics are fully encapsulated for ultra-reliability and a comprehensive fitting kit is supplied
- Slimline designed to be installed within the wall mount or in plastic trunking
- Electronic sensing reservoir therefore no float



Part No	Description	Max Head	Max Lift	Max Flow	Hose Connection	dBa
GMP48	Galaxy Electronic Smart Pump	5mt	1.5mt	12ltr/hour	¼"	21 dBa

Aspen Mini Aqua Pump & Aspen Mini Aqua Silent+ Pump



GMP25

GMP25S

- The world's slimmest condensate removal pump is designed to fit where others can't
- Combining Silent+ technology and the slimmest mini pump on the market. Silent+ Mini Aqua leads the way in innovation

Part No	Description	Model	Max Head	Max Lift	Max Flow	Hose Connection	dBa
GMP25	Aspen Mini Pump	Mini Aqua	10mt	2mt	12ltr/hour	¼"	21 dBa
GMP25S	Aspen Mini Pump	Mini Aqua Silent+	10mt	2mt	12ltr/hour	¼"	19 dBa

Aspen Mini Tank Pump

- The 'Mini' tank pump can be wall mounted, floor mounted, in-pan or suspended on M8/ M10 threaded rod
- Using piston technology this is a compact, powerful and multi-functional tank pump



Part No	Description	Model	Tank Size	Max Head	Max Flow	Hose Connection	dBa
GMP49	Aspen Tank Pump	Mini Tank	0.24ltr	15mt	35ltr/hour	¼" & ⅜"	35 dBa

Aspen Mini Orange Pump



- Small & powerful, quiet & reliable pump
- Submersible secondary reservoir included
- Plug & play
- Anti-siphon device

Part No	Description	Model	Max Head	Max Lift	Max Flow	Hose Connection	dBa
GMP14	Aspen Mini Pump	Mini Orange	10mt	2mt	12ltr/hour	¼"	21 dBa

Aspen Mini Orange Silent+ Pump



- Small & powerful, quiet & reliable pump
- Submersible secondary reservoir included
- Plug & play
- Anti-siphon device
- The quietest in its class, featuring an acoustic damper, anti-vibration tubing and bracket
- A Silent+ Mini Orange is whisper quiet

Part No	Description	Model	Max Head	Max Lift	Max Flow	Hose Connection	dBa
GMP14S	Aspen Mini Pump	Mini Orange Silent+	10mt	2mt	12ltr/hour	¼"	19 dBa

Aspen Maxi Orange Pump



- Perfect for large commercial units
- Superior performance with high power motor
- Submersible secondary reservoir included
- Designed for larger units, the Maxi Orange pump gives you the extra power when you need it

Part No	Description	Model	Max Head	Max Lift	Max Flow	Hose Connection	dBa
GMP23	Aspen Maxi Pump	Maxi Orange	15mt	2mt	35ltr/hour	¼"	35 dBa

Blue Diamond MicroBlue Pump c/w Trunking

BLUEDIAMOND
CONDENSATE REMOVAL PUMPS

- The MicroBlue™ is the only ductless pump on the market that can remove sediment/ debris with no need of filters or regular servicing intervals
- Smooth flow rate from the MicroBlue™ eliminates the necessity for any pulsating free tubing and silencing devices
- Can be mounted in any orientation up to 5m away from the air conditioning unit operating both wet and dry continuously
- Silent operation
- 70mm Speediduct trunking



Part No	Description	Model	Trunking	Max Head	Max Lift	Max Flow	Hose Connection	dBa
GMP90	Blue Diamond Pump	Micro Blue	SpeediDuct - White	5mt	2mt	5ltr/hour	¼"	17 dBa
GMP94	Blue Diamond Pump	Micro Blue	SpeediDuct - Ivory	5mt	2mt	5ltr/hour	¼"	17 dBa

Blue Diamond Mini Blue Diaphragm Pump - Temperature Sensor

BLUEDIAMOND
CONDENSATE REMOVAL PUMPS

- Mini Blue condensate removal pump provides installers complete flexibility when it comes to positioning the pump
- Whisper quiet
- No maintenance required
- Positive displacement pump eliminates need for check valve or siphon
- Tolerates suspended solids
- Capable of running dry without an overheating failure
- 2mt temperature sensor



Part No	Description	Model	Max Head	Max Lift	Max Flow	Hose Connection	dBa
GMP43	Blue Diamond Pump	Mini Blue T° Sensor	8mt	5mt	8ltr/hour	¼"	21 dBa

Blue Diamond Maxi Blue Diaphragm Pump - Temperature Sensor

BLUEDIAMOND
CONDENSATE REMOVAL PUMPS

- The Maxi Blue is a small yet powerful pump, using the same patented sensing technology as the rest of the range.
- Designed for high humidity environments, the Maxi Blue only senses when water is present, offering an energy efficient drainage solution for condensate removal
- The pump can be mounted in any orientation and is exceptionally quiet with no vibration, making it ideal for installations where low noise levels are key



Part No	Description	Model	Max Head	Max Lift	Max Flow	Hose Connection	dBa
GMP91	Blue Diamond Pump	Maxi Blue T° Sensor	8mt	8mt	14ltr/hour	¼"	21 dBa

Blue Diamond Maxi Blue Diaphragm Pump - Drainstik Sensor

BLUEDIAMOND
CONDENSATE REMOVAL PUMPS



- The BlueDiamond patented Drainstik is a slim line probe, which houses the water sensors and high level alarm
- Can be directly mounted into the drain tube

Part No	Description	Model	Max Head	Max Lift	Max Flow	Hose Connection	dBa
GMP93	Blue Diamond Pump	Maxi Blue Drainstik	8mt	8mt	14ltr/hour	¼"	21 dBa

Blue Diamond Maxi Blue Diaphragm Pump - Reservoir Sensor

BLUEDIAMOND
CONDENSATE REMOVAL PUMPS



- With no moving parts the Maxi Blue reservoir sensor offers a reliable alternative to stuck or sunken float switches

Part No	Description	Model	Max Head	Max Lift	Max Flow	Hose Connection	dBa
GMP92	Blue Diamond Pump	Maxi Blue Reservoir	8mt	8mt	14ltr/hour	¼"	21 dBa

Blue Diamond Mega Blue Diaphragm Pump - Reservoir Sensor

BLUEDIAMOND
CONDENSATE REMOVAL PUMPS



- Whilst being exceptionally quiet, it is also able to pump up to six storeys high, making the Mega Blue ideal for installations where distance is required

Part No	Description	Model	Max Head	Max Lift	Max Flow	Hose Connection	dBa
GMP41	Blue Diamond Pump	Mega Blue Reservoir	20mt	7mt	50ltr/hour	¼"	23 dBa

Aspen Refrigeration Cabinet Pump - 11 Ltr

ASPEN
PUMPS



Top Inlet

- Made of robust plastic, the lightweight ERRP (Economic Retail Refrigeration Pump) effectively pumps away defrost water and filters debris

Part No	Description	Model	Tank Size	Max Head	Max Flow	High Level Switch	Size	dBa
GMP38	Aspen Cabinet Pump	ERRP	11ltr	35mt	225ltr/hour	Yes	590 x 405 x 100mm	60 dBa

Aspen Refrigeration Cabinet Pump - 3.5 Ltr

ASPEN
PUMPS



Top Inlet



- Designed exclusively to fit underneath retail refrigeration cabinets the lightweight plastic ERRP (Economic Retail Refrigeration Pump) allows for the removal of defrost and contaminated water

Part No	Description	Model	Tank Size	Max Head	Max Flow	High Level Switch	Size	dBa
GMP98	Cabinet Pump	Low Profile ERRP	3.5ltr	21mt	190ltr/hour	Yes	530 x 240 x 75mm	60 dBa

Hydron Dairy Pump - 5Ltr

HYDRON



- The HY/DP30-S is a low profile, yet powerful, piston pump designed for use with dairy case installations
- Its ultra low height also means that it can be used for dairy cases where height is a restriction
- It has been designed for when low gravity drain is not available.
- Made in Britain

Part No	Description	Model	Tank Size	Max Head	Max Flow	Inlet	Size	Voltage
GMP36	Dairy Pump	Low Profile	5ltr	30mt	110ltr/hour	Top & Side	465 x 205 x 63mm	230V

Aspen Replacement Pump Tubes

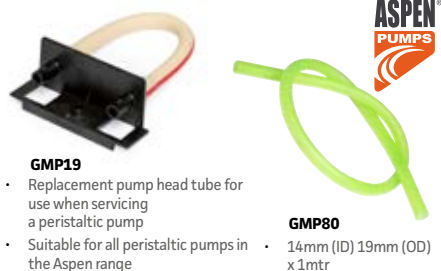

- GMP19**
 - Replacement pump head tube for use when servicing a peristaltic pump
 - Suitable for all peristaltic pumps in the Aspen range
- GMP80**
 - 14mm (ID) 19mm (OD) x 1mtr

Part No	Description	Size	Length
GMP19	Peristaltic Tube		
GMP80	Flexible Rubber Tube	14mm ID/19mm OD	1mtr

Aspen 1.0Amp Fuse & Holder



- Protects Aspen condensate pumps from power overload

Part No	Description	Qty/Pk
GMP28	Aspen 1.0 Amp Fuse & Holder	pk 2

Unit To Pipe Connectors / Rubber Unit Adapters & Tank Pump Connectors



- Rubber adaptors to connect a condensate drain pipe to a cassette unit
- Rubber adapters to connect a condensate drain pipe to a tank pump

Part No	Description	Suitable For	Size	Qty/Pk
GMP85	Green Rubber Adapters		¾" - 1"	pk 3
GMP86	Blue Rubber Adapters		¾" - 1¼"	pk 3
GMP87	Black Rubber Adapters		¾" - 1¼"	pk 3
GMP110	Rubber Tank Pump Connectors	LG Units	16mm - 21mm	pk 3
GMP111	Rubber Tank Pump Connectors	Daikin & Panasonic Units	26mm - 21mm	pk 3
GMP112	Rubber Tank Pump Connectors	Daikin, Panasonic, Mitsubishi Electric & Mitsubishi Heavy Units	32mm - 21mm	pk 3

Consolve Drain Adapter

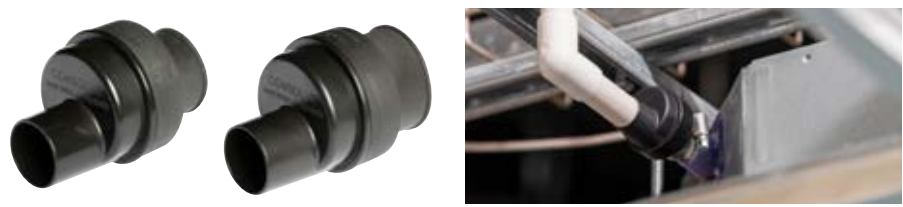

- Features a flexible rubber end to clamp to the drain outlet of the AC unit and a solvent weld connection for the drain pipe
- Automotive grade rubber
- Hydrodynamically designed for an unrestricted flow of condensate

Part No	Description	Size	Qty/Pk
GMCS1	Consolve Drain Adapter	1" - ¾"	Each
GMCS2	Consolve Drain Adapter	1¼" - ¾"	Each

Air Conditioning Electrical

Contents

SY Electrical Cable	162
Envirotuff Cable & Stripper	163
CY Screened Control Cable	164
Flex Cables	165
Assorted Air Conditioning Cables	166
Electrical Indoor Plastic Isolators	167
Pattress Boxes & Outdoor Rotary Isolators	168
Electrical Moulded Enclosures	169
Metal Clad Isolators & Contractors Packs	170
Stuffing Glands & Grommets	171
Electrical Connectors & Crimps	172
Cable Ties & Cable Cutters	173
Cable Tie Bases & Insulation Tapes	174

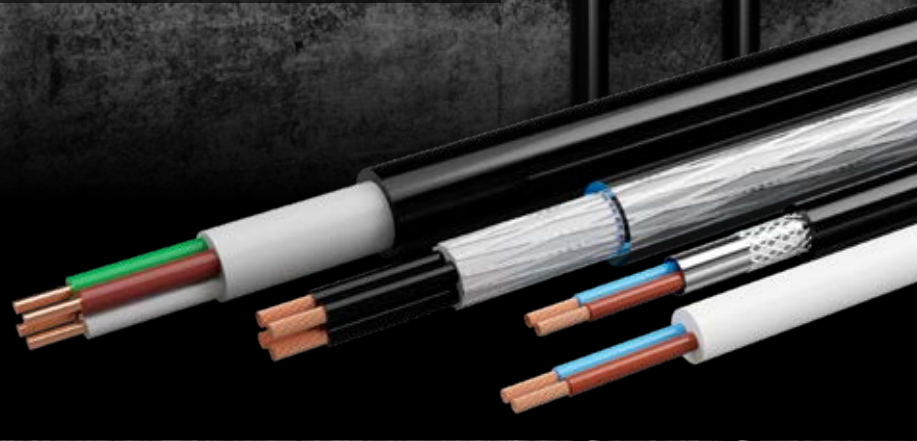

SY Braided Sheath Cable



Clear SY

Black SY

- PVC insulated and sheathed flexible cable with galvanised steel wire braiding providing mechanical protection

1.5mm SY Braided Sheath Cable

Part No	Description	Colour	Size	Length	Gland Size
GMEC15-100	3 Core SY Cable	Clear	1.5mm	100mt	20S
GMEC16-100	4 Core SY Cable	Clear	1.5mm	100mt	20S
GMEC16-25	4 Core SY Cable	Clear	1.5mm	25mt	20S
GMEC16-50	4 Core SY Cable	Clear	1.5mm	50mt	20S
GMEC16B-50	4 Core SY Cable	Black	1.5mm	50mt	20S
GMEC16B	4 Core SY Cable	Black	1.5mm	100mt	20S
GMEC17-100	5 Core SY Cable	Clear	1.5mm	100mt	20S
GMEC18-100	7 Core SY Cable	Clear	1.5mm	100mt	20L

1.5mm SY UV Protection Braided Sheath LSOH Cable

Part No	Description	Colour	Size	Length	Gland Size
GMEC16BUV-100	4 Core SY UV Protection Cable LSOH	Black	1.5mm	100mt	20S

2.5mm SY Braided Sheath Cable

Part No	Description	Colour	Size	Length	Gland Size
GMEC19-100	3 Core SY Cable	Clear	2.5mm	100mt	20S
GMEC20-100	4 Core SY Cable	Clear	2.5mm	100mt	20S
GMEC21-100	5 Core SY Cable	Clear	2.5mm	100mt	20L

4.0mm SY Braided Sheath Cable

Part No	Description	Colour	Size	Length	Gland Size
GMEC23-25	3 Core SY Cable	Clear	4.0mm	25mt	20L
GMEC25-50	5 Core SY Cable	Clear	4.0mm	50mt	25L

Envirotuff Cable



- Black cable suitable for interior or exterior use
- Black PVC sheath - resistant to impact, UV and water
- For use with standard stuffing glands
- The ideal time and cost saving alternative to SWA where possible

1.5mm Envirotuff Cable

Part No	Description	Colour	Size	Length	Gland Size
GMEC80	3 Core Envirotuff Cable	Black	1.5mm	100mt	20L
GMEC81-100	4 Core Envirotuff Cable	Black	1.5mm	100mt	20L
GMEC81-50	4 Core Envirotuff Cable	Black	1.5mm	50mt	20L
GMEC82	5 Core Envirotuff Cable	Black	1.5mm	100mt	20L

2.5mm Envirotuff Cable

Part No	Description	Colour	Size	Length	Gland Size
GMEC84	3 Core Envirotuff Cable	Black	2.5mm	100mt	20L
GMEC85	4 Core Envirotuff Cable	Black	2.5mm	100mt	20L
GMEC86	5 Core Envirotuff Cable	Black	2.5mm	100mt	20L

4.0mm Envirotuff Cable

Part No	Description	Colour	Size	Length	Gland Size
GMEC88	3 Core Envirotuff Cable	Black	4.0mm	100mt	20L
GMEC90	5 Core Envirotuff Cable	Black	4.0mm	100mt	25L

Envirotuff Cable Stripper



- Quick and exact cutting of most flexible cables
- Each stripper supplied with spare blades stored in the handle

Part No	Description
GMSTP	Envirotuff Cable Stripper

CY Screened Control Cables

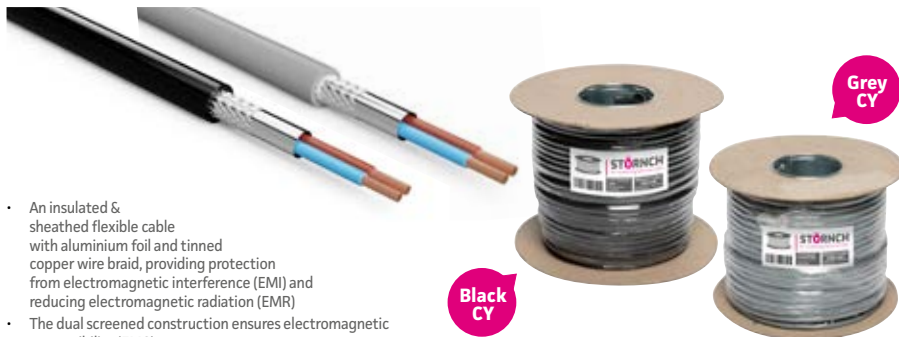

- An insulated & sheathed flexible cable with aluminium foil and tinned copper wire braid, providing protection from electromagnetic interference (EMI) and reducing electromagnetic radiation (EMR)
- The dual screened construction ensures electromagnetic compatibility (EMC)

Black
CYGrey
CY

0.5mm CY Screened Control Cable

Part No	Description	Colour	Size	Length
GMEC29	4 Core CY Cable	Grey	0.5mm	100mt

0.75mm CY Screened Control Cables

Part No	Description	Colour	Size	Length
GMEC30B	2 Core CY Cable	Black	0.75mm	100mt
GMEC30G	2 Core CY Cable	Grey	0.75mm	100mt
GMEC31	3 Core CY Cable	Grey	0.75mm	100mt

0.75mm CY Screened LS0H Control Cable

Part No	Description	Colour	Size	Length
GMEC30LSF	2 Core LS0H CY Cable	Grey	0.75mm	100mt

1.0mm CY Screened Control Cable

Part No	Description	Colour	Size	Length
GMEC42	2 Core CY Cable	Grey	1.0mm	100mt

1.5mm CY Screened Control Cables

Part No	Description	Colour	Size	Length
GMEC36B	2 Core CY Cable	Black	1.5mm	100mt
GMEC36G	2 Core CY Cable	Grey	1.5mm	100mt
GMEC37	3 Core CY Cable	Grey	1.5mm	100mt
GMEC38	4 Core CY Cable	Grey	1.5mm	100mt

1.5mm CY Screened LS0H Control Cables

Part No	Description	Colour	Size	Length
GMEC36LSF	2 Core LS0H CY Cable	Grey	1.5mm	100mt
GMEC36LSF	2 Core CY LS0H Cable	Black	1.5mm	100mt

Flex Cables



- The light-duty is designed for use in domestic appliances with a voltage rating of 300/500V, kitchens and offices
- It is suitable for use where the potential for mechanical stresses and mechanical damage is low

0.75mm Flex Cables

Part No	Description	Colour	Size	Length
GMEC100B	2 Core Flex Cable	Black	0.75mm	100mt
GMEC100W	2 Core Flex Cable	White	0.75mm	100mt
GMEC101B	3 Core Flex Cable	Black	0.75mm	100mt
GMEC102B	4 Core Flex Cable	Black	0.75mm	100mt

0.75mm LS0H Flex Cable

Part No	Description	Colour	Size	Length
GMEC100LSFB	2 Core LS0H Flex Cable	Black	0.75mm	100mt

1.0mm Flex Cables

Part No	Description	Colour	Size	Length
GMEC104B	2 Core Flex Cable	Black	1.0mm	100mt
GMEC104W	2 Core Flex Cable	White	1.0mm	100mt

1.5mm Flex Cables

Part No	Description	Colour	Size	Length
GMEC105B	2 Core Flex Cable	Black	1.5mm	100mt
GMEC105W	2 Core Flex Cable	White	1.5mm	100mt
GMEC106B	3 Core Flex Cable	Black	1.5mm	100mt
GMEC106W	3 Core Flex Cable	White	1.5mm	100mt
GMEC107B	4 Core Flex Cable	Black	1.5mm	100mt

1.5mm LS0H Flex Cables

Part No	Description	Colour	Size	Length
GMEC105LSFB	2 Core LS0H Flex Cable	Black	1.5mm	100mt
GMEC106LSFB	3 Core LS0H Flex Cable	Black	1.5mm	100mt
GMEC111	4 Core LS0H Flex Cable	Black	1.5mm	100mt

2.5mm Flex Cables

Part No	Description	Colour	Size	Length
GMEC109B	3 Core Flex Cable	Black	2.5mm	100mt
GMEC109W	3 Core Flex Cable	White	2.5mm	100mt
GMEC110B	4 Core Flex Cable	Black	2.5mm	100mt

LSF200 Fire Cables



- Fire resistant cable
- LSOH screened cable
- BASEC approved
- Designed to perform during fire and mechanical impact

Part No	Description	Colour	Size	Length
GMEC66	3 Core + Earth LSF200	White	1.5mm	100mt
GMEC67	4 Core + Earth LSF200	White	1.5mm	100mt
GMEC68	2 Core + Earth LSF200	White	2.5mm	100mt

Flexishield Cables



- Fail safe - can withstand fault currents of up to 200A
- Flexible - pliable yet robust
- Shielded - bonded aluminium tube
- UV stable sheath - can be used outside
- LSOH - Low Smoke Zero Halogen

Part No	Description	Colour	Size	Length
GMEC140	3 Core & Earth - BS8436	Black	1.5mm	100mt
GMEC142	2 Core & Earth - BS8436	Black	2.5mm	100mt

HO7RN-F Cables



- An elastomeric insulated and sheathed flexible trailing cable
- The mechanical and chemical characteristics of the rubber compound provides good abrasion resistance and the ability to withstand many oils and chemicals
- The construction and performance enables the product to be used in arduous and low temperature conditions

Part No	Description	Colour	Size	Length
GMEC151	4 Core HO7RN-F	Black	1.5mm	100mt
GMEC155	4 Core HO7RN-F	Black	2.5mm	100mt

Grey YY Cables



- A PVC insulated and sheathed flexible cable for applications where cable flexibility will simplify installation
- Very versatile for energy distribution and control applications

Part No	Description	Colour	Size	Length
GMEC45	2 Core YY Cable	Grey	0.75mm	100mt
GMEC49	7 Core YY Cable	Grey	0.75mm	100mt
GMEC50	2 Core YY Cable	Grey	1.5mm	100mt
GMEC52	4 Core YY Cable	Grey	1.5mm	100mt

Switched Fused Spur Isolator



- For indoor use only
- Printed with 'Air Conditioning'

Part No	Description	Current
GMS120	Switched Fused Spur Indoor Isolator	13 Amp

Switched Fused Spur Isolator - Neon



- For indoor use only
- Printed with 'Air Conditioning'

Part No	Description	Current
GMS121	Switched Fused Spur Indoor Isolator - Neon	13 Amp

Double Pole Isolator



- For indoor use only
- Printed with 'Air Conditioning'

Part No	Description	Current
GMS122	Double Pole Isolator	20 Amp

Double Pole Isolator - Neon



- For indoor use only
- Printed with 'Air Conditioning'

Part No	Description	Current
GMS123	Double Pole Isolator - Neon	20 Amp

Fan Switch Isolator



- For indoor use only
- Printed with a fan symbol

Part No	Description	Current
GMS130	3 Pole Fan Switch Isolator	6 Amp

1 Gang Blanking Plate



- For indoor use only

Part No	Description	Size
GMS132	Blanking Plate	1 Gang

25mm Pattress Box



- For indoor use only
- 87 x 87 x 25mm

Part No	Description	Size
GMIS25	Pattress Box	25mm

45mm Pattress Box



- For indoor use only
- 87 x 87 x 45mm

Part No	Description	Size
GMIS26	Pattress Box	45mm

Dry Lining Pattress Box



- For indoor use only
- 86 x 86 x 35mm

Part No	Description	Size
GMIS27	Dry Lining Pattress Box	35mm

Pattress Box c/w Knock-Outs



- For indoor use only
- Unbreakable Plastic

Part No	Description	Size
GMIS31	Pattress c/w 20mm Knock-Outs	35mm

Salzer IP66 Outdoor Rotary Isolators



- High quality IP66 rated weatherproof isolator for use outdoors
- c/w Lock-off facility

Part No	Description	Current
GMIS1	4 Pole Outdoor Rotary Isolator	20 Amp
GMIS2	4 Pole Outdoor Rotary Isolator	32 Amp

IP65 Outdoor Rotary Isolators



- IP65 rated isolators with a lock-off facility
- Internal block clips off for ease of wiring
- Weatherproof

Part No	Description	Current
GMIS7	4 Pole Outdoor Rotary Isolator	20 Amp
GMIS8	4 Pole Outdoor Rotary Isolator	32 Amp
GMIS3	4 Pole Outdoor Rotary Isolator	40 Amp

IP55 Moulded Enclosure



- Manufactured from high impact, self extinguishing ABS material
- Weatherproof

Part No	Description	Size	No of Entries
GMEA13	Moulded Enclosure	100 x 100 x 50mm	6

IP55 Moulded Enclosure



- Manufactured from high impact, self extinguishing ABS material
- Weatherproof

Part No	Description	Size	No of Entries
GMEA17	Moulded Enclosure	300 x 220 x 120mm	12

IP65 Moulded Enclosure



- Complete with self-seal entry
- Easy cable feed through high level terminals
- Ample wiring space
- Rugged construction
- Weatherproof

Part No	Description	Size	No of Knock-Outs
GMEA50	Moulded Enclosure	80 x 80 x 53mm	7

IP65 Moulded Enclosure



- Complete with self-seal entry
- Easy cable feed through high level terminals
- Ample wiring space
- Rugged construction
- Weatherproof

Part No	Description	Size	No of Knock-Outs
GMEA51	Moulded Enclosure	110 x 110 x 67mm	7

IP65 Moulded Enclosure



- Complete with self-seal entry
- Easy cable feed through high level terminals
- Ample wiring space
- Rugged construction
- Weatherproof

Part No	Description	Size	No of Knock-Outs
GMEA52	Moulded Enclosure	140 x 140 x 79mm	10

IP66 Black Moulded Enclosure



- Includes seven pre-moulded 20mm threaded entries for glands.
- Lid is fixed with 3/4 turn locking screws
- Weatherproof

Part No	Description	Size	No of Knock-Outs
GMEA18	Moulded Enclosure	102 x 102 x 57mm	7

Metal Clad Switched Fused Spur Isolator



- For indoor use only
- c/w metal pattress box + flex outlet
- Printed with 'Air Conditioning'

Part No	Description	Current
GMS12	Metal Clad Switched Fused Spur Isolator	13 Amp

Metal Clad Switched Fused Spur Isolator - Neon



- For indoor use only
- c/w metal pattress box + flex outlet
- Printed with 'Air Conditioning'

Part No	Description	Current
GMS13	Metal Clad Switched Fused Spur Isolator - Neon	13 Amp

Metal Clad Double Pole Isolator



- For indoor use only
- c/w metal pattress box + flex outlet
- Printed with 'Air Conditioning'

Part No	Description	Current
GMS10	Metal Clad Double Pole Isolator	20 Amp



Flexi Conduit Contractors Pack



- Pack includes 10mt of flexi-conduit and 10 glands

Part No	Description	Size	Length
GMEA32	Flexi Conduit Contractors Pack	20mm	10mt

Flexi Conduit Contractors Pack



- Pack includes 10mt of flexi-conduit and 10 glands

Part No	Description	Size	Length
GMEA33	Flexi Conduit Contractors Pack	25mm	10mt

Black Stuffing Glands



- IP68 rated
- c/w sealing washer & lock nut
- For use with our range of cables

Part No	Description	Size Range	Qty/Pk
GMEA1B	20mm Small Gland	6mm - 12mm	pk 10
GMEA2B	20mm Large Gland	10mm - 14mm	pk 10
GMEA3B	25mm Small Gland	12mm - 15mm	pk 10
GMEA4B	25mm Large Gland	14mm - 18mm	pk 10

White Stuffing Gland



- IP68 rated
- c/w sealing washer & lock nut
- For use with our range of cables

Part No	Description	Size Range	Qty/Pk
GMEA2W	20mm Large Gland	10mm - 14mm	pk 10

SWA Glands Kits



- Outdoor Gland Kits for SWA cable
- Used for terminating and securing cable

Part No	Description	Size	Qty/Pk
GMEA43	CW Outdoor SWA Gland Kit	20S	Pair
GMEA44	CW Outdoor SWA Gland Kit	20L	Pair

110v & 240v Plug Tops



- BSI approved

Part No	Description	Size	Qty/Pk
GMEA20	240v 3 Pin Plastic Plug Top	13 Amp	Each
GMEA29	110v 3 Pin Plastic Plug Top	16 Amp	Each

Black Open Rubber Grommets

GMEA25



GMEA27



- Grommets are commonly used in electrical installations to protect cables from chafing. They are used when wires need to pass through a hole, typically electrical boxes and enclosures

Part No	Description	Size	Qty/Pk
GMEA25	Open Rubber Grommets	20mm	pk 100
GMEA27	Open Rubber Grommets	25mm	pk 100

Black Closed Rubber Grommets



- Closed grommets are commonly used for blanking holes in electrical boxes and enclosures

Part No	Description	Size	Qty/Pk
GMEA26	Closed Rubber Grommets	20mm	pk 100
GMEA28	Closed Rubber Grommets	25mm	pk 100

Wago 2, 3 & 5 Way Terminals



Part No	Description	Qty/Pk
GMCC21	Wago 2 Way Terminal	pk100
GMCC22	Wago 3 Way Terminal	pk50
GMCC23	Wago 5 Way Terminal	pk25

- Easily terminate conductors from 0.14 to 4 mm²
- Connect solid, stranded and fine-stranded conductors
- Safely install long cable runs with larger conductor cross sections

Electrical Connector Blocks



- Screw-type electrical connector
- Used to secure and/or terminate wires

Part No	Description	Current	Qty/Pk
GMCC18	Electrical Connector Blocks	5 Amp	10 Strips
GMCC19	Electrical Connector Blocks	15 Amp	10 Strips
GMCC20	Electrical Connector Blocks	30 Amp	10 Strips

Electrical Ring Crimps



- Pre-insulated terminals
- Red 5.3mm Hole Dia
- Blue 6.4mm Hole Dia
- Yellow 6.4mm Hole Dia

Part No	Description	Size	Qty/Pk
GMCC4	Red Ring Crimps	0.5 - 1.5mm ²	pk 100
GMCC10	Blue Ring Crimps	1.5 - 2.5mm ²	pk100
GMCC15	Yellow Ring Crimps	4.0 - 6.0mm ²	pk 100

Electrical Crimp Connectors



- Colour coded for easy wire size identification
- Easy to crimp using a ratchet tool
- Durable and reliable

Part No	Description	Size	Qty/Pk
GMCC1	Red Crimp Connector	0.5mm ² - 1.5mm ²	pk 100
GMCC7	Blue Crimp Connector	1.5mm ² - 2.5mm ²	pk 100

Aspen 1.0 Amp Fuse & Holder



- Protects Aspen condensate pumps from power overload

Part No	Description	Qty/Pk
GMP28	Aspen 1.0 Amp Fuse & Holder	pk 2

Cable Ties



- Used for cable management
- Function like straps to hold electrical cables or wires in place, and keep them tidy

Part No	Description	Size	Qty/Pk
GM300I	Cable Ties	300mm x 3.6mm	pk 100
GM300ST	Cable Ties	300mm x 4.8mm	pk 100
GM300ST-NAT	Cable Ties (Natural)	300mm x 4.8mm	pk 100

Part No	Description	Size	Qty/Pk
GM300HD	Cable Ties	300mm x 7.6mm	pk 100
GM370ST	Cable Ties	370mm x 4.8mm	pk 100
GM380HD	Cable Ties	380mm x 7.6mm	pk 100
GM450HD	Cable Ties	430mm x 9.0mm	pk 100

Releasable Cable Ties

- Reusable
- c/w a small release clip which allows you to undo and reattach them as required

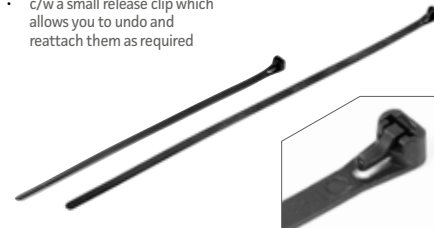

Part No	Description	Size	Qty/Pk
GM250HTD	Releasable Cable Ties	250mm x 7.6mm	pk 100
GM380HTD	Releasable Cable Ties	370mm x 7.6mm	pk 100

Stainless Steel Cable Ties

- For use where additional strength, security and fire resistance is required
- Roller-ball locking mechanism
- 316 grade stainless steel

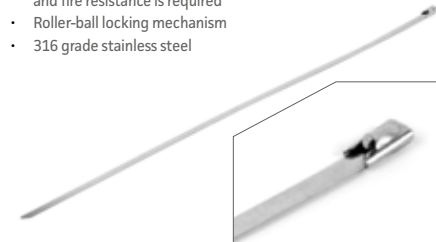

Part No	Description	Size	Qty/Pk
GM300STST	Stainless Steel Cable Ties	300mm x 4.8mm	pk 100

Cable Cutters



- Special alloy steel construction, with induction hardened cutting edges
- Special profile blade for effective cable cutting & wire stripping
- Suitable for copper & aluminium wire only

Part No	Description	Size
GMHS7	Cable Cutters	9 1/2"

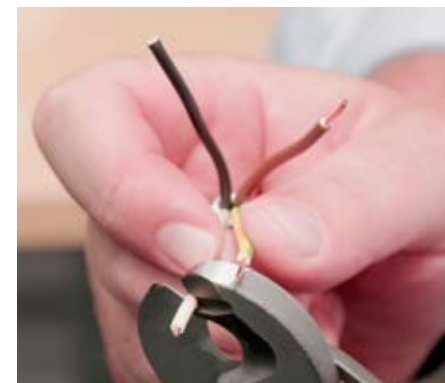

Cable Tie Bases



GMCTA1

- Push in fixing for cable ties up to 9mm wide
- Drill 6-8mm hole in brick, block, concrete or wood

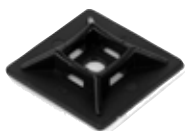

GMAM2

- Peel off backing paper and stick to surface



GMSM2

- Saddle design provides maximum stability
- Fix mounts with screw



Part No	Description	Size	Qty/Pk
GMCTA1	Cable Tie Anchors	37mm Long	pk 100
GMAM2	S/A Cable Tie Bases	28mm x 28mm	pk 100
GMSM2	Screw Tie Bases	Suits 4.8 - 8.0 Ties	pk 100

19mm Electrical Insulation Tapes



- Used to insulate electrical wires, and other materials that conduct electricity
- Stretches well, and gives an effective and long-lasting insulation

Part No	Description	Colour	Size
GMT1B	PVC Insulation Tape	Black	19mm x 33mt
GMT1BL	PVC Insulation Tape	Blue	19mm x 33mt
GMT1BR	PVC Insulation Tape	Brown	19mm x 33mt

Part No	Description	Colour	Size
GMT1R	PVC Insulation Tape	Red	19mm x 33mt
GMT1W	PVC Insulation Tape	White	19mm x 33mt
GMT1Y	PVC Insulation Tape	Yellow	19mm x 33mt
GMT1E	PVC Insulation Tape	Earth	19mm x 33mt

50mm Electrical Insulation Tapes



Part No	Description	Colour	Size
GMT2	PVC Insulation Tape	Black	50mm x 33mt
GMT2BLU	PVC Insulation Tape	Blue	50mm x 33mt
GMT2WH	PVC Insulation Tape	White	50mm x 33mt

- Used to insulate electrical wires, and other materials that conduct electricity
- Stretches well, and gives an effective and long-lasting insulation

Service, Maintenance, Tools & Site Supplies

Contents

Disinfectant Evaporator Cleaners	177-179
Universal Cleaners	181-182
Condenser-Only Cleaners	184-185
Evaporator-Only Cleaners	187-188
Smell and Odour Cleaners	190-192
Case Cleaner	193
Drain Maintenance	194-195
Leak Detection	196
Special Chemicals	197
Spray Bottles & Wipes	198
Cleaning Wipes	199
Personal Protective Equipment	200-201
Tools - Press Tools & Accessories	202-206
Tools - Tube & Pipe Cutters	207-209
Tools - Tube & Pipe Benders	210-213
Tools - Press Expanders & Flaring	214-215
Tools - Deburring & Bevelling	216
Tools - Brazing	217-218
Tools - Charging/Weighing Scales	219
Tools - Recovery Units	220-221
Tools - Vacuum Pumps	222-223
Tools - Gauges, Manifolds & Hoses	224-227
Tools - Testing Instruments	228-230
Tools - Service & Maintenance	231
Tools - Drill Bits & Holesaws	232-233
Tools - Blades & Knives	234-235
Tools - Driver Bits & Punches	236-237
Sealants, Adhesives & Sprays	238-239
Tools - Site Supplies	240
Portable Air Conditioning Unit	241



Disinfectant Evaporator Cleaners

Service, Maintenance, Tools & Site Supplies
Disinfectant Evaporator Cleaners



CondensCide Evaporator Cleaner & Disinfectant



Nonfood Compounds Program Listed



- Verified to kill SARS-CoV-2 virus (which leads to Covid-19)
- Kills 99.9% of bacteria in 60 seconds or less
- Improves energy efficiency and indoor air quality



Concentrate



Condensate Pump Safe



Indoor Units



RTU (Ready To Use) Evaporator Cleaner & Disinfectant



- Verified to kill the SARS-CoV-2 virus (which leads to Covid-19)
- Kills 99.9% of bacteria in 60 seconds or less
- Convenient ready-to-use format



Ready to Use



Condensate Pump Safe



Indoor Units



Service, Maintenance, Tools & Site Supplies
Disinfectant Evaporator Cleaners

Frionett Activ' Concentrated Cleaner

FRIONETT®

- Superb product for disinfecting, degreasing and deodorising products for refrigeration and air conditioning systems
- Formulated to effectively combat bacteria including legionella, salmonella and listeria
- Contains an effective fungicide and virucide and is backed by full EU approval

- Concentrate
- Condensate Pump Safe
- Indoor Units



Part No	Description	Size
GMP41	Frionett Activ Concentrated Cleaner	5 Ltr

EasyCare Evaporator Cleaner & Disinfectant



- Aerosol
- Condensate Pump Safe
- Indoor Units

- Verified to kill the SARS-CoV-2 virus (which leads to Covid-19)
- Kills 99.9% of bacteria in 60 seconds or less
- Improves indoor air quality
- Removes grease, nicotine and grime



Part No	Description	Size
GMP7	Evaporator Cleaner & Disinfectant	600ml

StayClean Mini Tablets - Condensate Tray Bacterial Control

Advanced A

- For drain maintenance
- Controls odours
- Reduces sludge build-up
- Minimises risk of blockages
- One tablet offers up to 8 weeks protection



- Condensate Pump Safe
- Indoor Units

Part No	Description	Qty/Pk
GMP18B	StayClean Mini Tablets	pk 20

StayClean Strips - Condensate Tray Bacterial Control

Advanced A

- Condensate Pump Safe
- Indoor Units

- An effective antibacterial treatment, providing up to six months protection from bacteria, fungi, algae and other micro-organisms that can cause smells and blockages in air conditioning condensate trays
- The strips have a unique built-in inhibitor to protect equipment from rust and corrosion



Part No	Description	Qty/Pk
GMP18	StayClean Strips	pk 6

Jally Strips

Advanced A

- For Refrigeration
- Condensate Pump Safe

- Slime dispersing action for refrigeration systems
- Smart release - extra biocidal power when needed
- Provides 12 months protection
- Safe to use in food preparation areas



Part No	Description	Qty/Pk
GMP21	Jally Strips	pk 6

Universal Cleaners



Diversitech Pro-Universal Coil Cleaner



Nonfood Compounds Program Listed

- Ideal for indoor and outdoor coils
- Degreaser, detergent, deodoriser
- Protects coils, and safe with condensate pumps
- Fin friendly formula – removes the dirt not the metal
- High dilution ratios – great value for money*
- NSF Food-Safe registered product – can be used in food preparation and storage areas

- Concentrate
- Condensate Pump Safe
- Indoor Units
- Outdoor Units



Part No	Description	Size
GMP50	Pro-Universal Coil Cleaner	5L

Dilution Ratio:
*10:1 = 55 litres - Evaporator. 6:1 = 35 litres - Condenser.

EnviroCoil Universal Coil Cleaner



- Biodegradable, environmentally friendly and mild formulation
- Perfect for most maintenance, indoors or outdoors
- Contains no acids, phosphates, sodium/potassium hydroxide
- Makes 25-45 litres*

- Concentrate
- Condensate Pump Safe
- Indoor Units
- Outdoor Units



Part No	Description	Size
GMP80	EnviroCoil Universal Coil Cleaner	5L

Dilution Ratio:
*1:8 - Evaporators. 1:4 - Condensers.

VerteX pH7 Neutral Universal Coil Cleaner



- Non corrosive - neutral pH 7 adaptive cleaner
- Quickly removes rust, scale, grease & fat
- Ideal for microchannel and coils with protective coatings
- Neutralises all unpleasant malodour
- Makes 25-45 litres*

- Concentrate
- Condensate Pump Safe
- Indoor Units
- Outdoor Units



Part No	Description	Size
GMP85	VerteX pH7 Neutral Universal Coil Cleaner	5L

Dilution Ratio:
*1:8 - Evaporators. 1:4 - Condensers.

EasyClean Universal Coil Cleaner



-  Aerosol
-  Condensate Pump Safe
-  Indoor Units
-  Outdoor Units

- Suitable for use on both air cooled evaporators and condensers
- Convenient, high powered aerosol
- Safe formulation
- Attacks only the dirt, not the coil

Part No	Description	Size
GMP6	EasyClean Universal Coil Cleaner	600ml

Condenser-Only Cleaners



Advanced A
RTU CC[®]
Condenser Cleaner

Removes all common types of dirt and debris
Non-flaming ready-to-use cleaner
Promotes system efficiency

SuperClean Heavy-Duty Condenser Cleaner



- Powerful foaming action that brightens the coil and inhibits future oxidation
- Just as powerful as an acid-based cleaner, but safer to use
- Strongest coil cleaner on the market, with a unique formulation
- Makes 25 litres*

- Concentrate
- Outdoor Units



Part No	Description	Size
GMP82	SuperClean Heavy-Duty Condenser Cleaner	5L

Dilution Ratio:
*1:4 - Condensers.

HydroFoam 2.0 Heavy Duty Condenser Cleaner & Brightener



- New coil brightening formula
- Non-toxic and biodegradable
- No degradation of aluminium or copper
- Cleans even the most stubborn baked-on dirt
- Makes 35 litres*

- Concentrate
- Outdoor Units



Part No	Description	Size
GMP84	HydroFoam 2.0 Heavy-Duty Condenser Cleaner	5L

Dilution Ratio:
*1:5 - Condensers.

RTU (Ready to Use) CC Condenser Cleaner



- Convenient non foaming ready-to-use cleaner
- Improves system efficiency
- Great as part of a regular maintenance programme

- Ready to Use
- Outdoor Units



Part No	Description	Size
GMP17	RTU CC Condenser Cleaner	1L

EasyFoam Heavy-Duty Condenser Cleaner

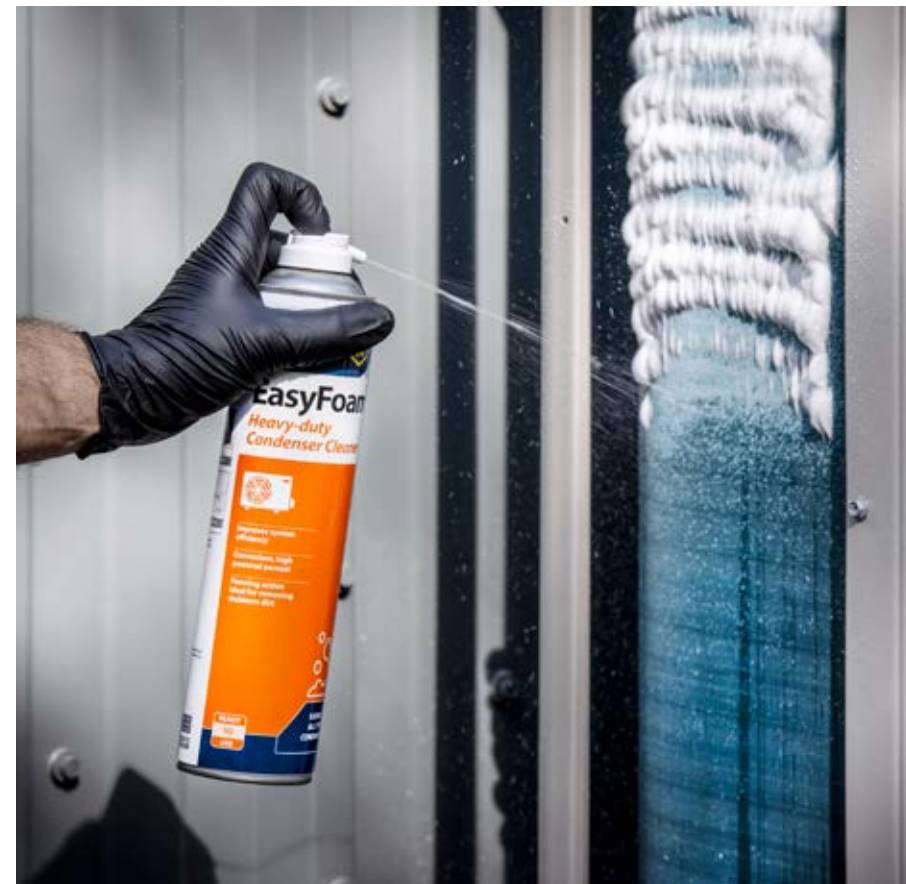

- Powerful formulation makes it ideal for removing stubborn dirt from problem coils
- Perfect for deep, multi-row condensers

- Aerosol
- Outdoor Units



Part No	Description	Size
GMP10	EasyFoam Heavy-Duty Condenser Cleaner	600ml

Evaporator-Only Cleaners

Service, Maintenance, Tools & Site Supplies
Evaporator-Only Cleaners



FRIONETT®

- Superb product for disinfecting, degreasing and deodorising products for refrigeration and air conditioning systems
- Formulated to effectively combat bacteria including legionella, salmonella and listeria
- Contains an effective fungicide and virucide and is backed by full EU approval

- Concentrate
- Condensate Pump Safe
- Indoor Units



Part No	Description	Size
GMP41	Fionett Activ Concentrated Cleaner	5 Ltr

Advanced A

- Verified to kill SARS-CoV-2 virus (which leads to Covid-19)
- Kills 99.9% of bacteria in 60 seconds or less
- Improves energy efficiency and indoor air quality

-
-
- Concentrate
- Condensate Pump Safe
- Indoor Units



Part No	Description	Size
GMP81	CondensCide Cleaner & Disinfectant	5 Ltr

Advanced A

- Verified to kill the SARS-CoV-2 virus (which leads to Covid-19)
- Kills 99.9% of bacteria in 60 seconds or less
- Convenient ready-to-use format

-
- Ready to Use
- Condensate Pump Safe



Part No	Description	Size
GMP16	RTU ECD Evaporator Cleaner & Disinfectant	1 Ltr

Service, Maintenance, Tools & Site Supplies
Evaporator-Only Cleaners

EasyFresh Odour Neutraliser for AC Systems



- Specifically designed for air conditioning units
- Eliminates odours
- Produces a long-lasting fresh scent

Part No	Description	Size
GMP12	EasyFresh Odour Neutraliser	400ml



OdourGuard



- A general purpose, 360° protection against odour and unpleasant smells from HVAC equipment. This odour absorbing formula eliminates odours and noxious smells created by smoke, mildew, pets and organic acids
- Triple blend of odour inhibitors and eliminators to ensure 360° protection
- Removes general odour, cigarette smoke, sweaty gym smells, pet odour, commercial kitchen smells, garlic and onion smells at home
- Self-reactivates on AC filters, after drying, with high humidity or water
- Formulated to be compatible with all surfaces including metal, alloys, plastic, ceramics, fabric, rubber, etc
- Non-toxic and biodegradable – ideal for household and industrial applications
- Does not interfere with existing perfume components in SmellyJellys

Part No	Description	Size
GMP30	Advanced OdourGuard	1L



Smell-Buster Odour Eliminator Spray



- This product is not a cover up perfume, but actually removes unpleasant smells from the air. It eliminates odours caused by smoke, mould, mildew, cat litter and pets, as well as noxious smells created by ammonia, hydrogen sulphide and other chemicals
- Easy-to-use Smell Buster has a pleasant, fresh smell

Part No	Description	Size
GMP56	Diversitech Smell Buster Spray	1L

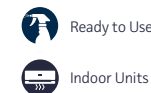

Smell-Buster Odour Eliminator Tub



- Unique odour elimination product that doesn't just 'mask' or 'cover up' bad smells but actually breaks down and removes bad smells from the air
- Non-toxic and approved for use in commercial and residential air systems

Part No	Description	Size
GMP57	Diversitech Smell Buster Tub	225g



AC Sanitiser Spray



- A two-in-one product that will banish odours and refresh AC Units
- Can also be used as an Air-Con de-odouriser which when sprayed into the air ducts and cooler matrix with the special adapter tube will clean, deodorise and freshen the complete Air-Con system on commercial units and even vehicles
- Leaves a pleasant mint fragrance

- Aerosol
- Indoor Units

Part No	Description	Size
GMAE15	AC Sanitiser Spray	500ml

SmellyJelly Fragrance & Gels



- Suitable for fan coil units

- Indoor Units

Part No	Description	Qty/Pk
GMMP20X	SmellyJelly Minis Mixed	pk 6



EasyFinish Fascia & Case Cleaner



- Suitable for most air conditioning units
- Safely removes finger marks etc. from plastic and metal casework
- Easily removes stubborn nicotine, grease & general grime

- Aerosol
- Indoor Units

Part No	Description	Size
GMMP9	EasyFinish Fascia & Case Cleaner	600ml

Drain Maintenance



Service, Maintenance, Tools & Site Supplies
Drain Maintenance

StayClean Strips - Condensate Tray Bacterial Control



- An effective antibacterial treatment, providing up to six months protection from bacteria, fungi, algae and other micro-organisms that can cause smells and blockages in air conditioning condensate trays
- The strips have a unique built-in inhibitor to protect equipment from rust and corrosion

Part No	Description	Qty/Pk
GMP18	StayClean Strips	pk 6

- Condensate Pump Safe
- Indoor Units

StayClean Mini Tablets - Condensate Tray Bacterial Control



- For drain maintenance
- Controls odours
- Reduces sludge build-up
- Minimises risk of blockages
- One tablet offers up to 8 weeks protection

Part No	Description	Qty/Pk
GMP18B	StayClean Mini Tablets	pk 20

- Condensate Pump Safe
- Indoor Units

DrainKleen Condensate Drain Cleaner



- Clears common blockages
- User friendly design for hard to reach areas

Part No	Description	Size
GMP71	Advanced DrainKleen	250ml

- Condensate Pump Safe
- Indoor Units

Gallo Drain Gun/Swoosh - For Unblocking Drain Hoses

- A lightweight, portable tool designed to unblock condensate drain lines and other pipework instantly. Simply insert a CO2 cartridge into the Gun and press the trigger
- Uses CO2, eliminating the mess caused by water back-flushing drain lines
- Carbon dioxide (CO2) is a common component of air, and so is totally safe.
- The preferred alternative to the environmentally unfriendly practice of using refrigerant to clean the drain line
- The flexible hose assembly enables you to manoeuvre through cabinets, coils and hard to reach drains
- A safety catch prevents the Gallo Gun from firing until the operator requires

Part No	Description	Qty/Pk
GMP52	Gallo Drain Gun/Swoosh	Each
GMP51A	Spare CO2 Cartridges	pk 12



Service, Maintenance, Tools & Site Supplies
Drain Maintenance

Leak Detection & Special Chemicals



Gotec Leak Detection Spray



- Non-flammable, non-toxic and non-corrosive leak detection
- Ready to use spray
- Will locate the smallest of leaks
- Use on any type of gas system
- 360° valve can be used at any angle

Part No	Description	Size
GMMP110	Gotec Leak Detection Spray	400ml

Pro-Bubble Leak Detection Spray



- High-bubbling viscoelastic blue leak detector
- New improved formula
- Easy to use spray nozzle

Part No	Description	Size
GMMP62	Pro-Bubble Leak Detection Spray	1L

Ice 'n' Clean Ice Machine Cleaner



- 250ml 'one shot' makes 10 litres of product, enough for one ice machine
- Suitable for use with all types of ice machines

Part No	Description	Size
GMMP13	Ice 'n' Clean Ice Machine Cleaner	250ml



Nonfood Compounds Program Listed



Diversi-Flush System Flushing Kit



- For flushing dirty and contaminated systems
- Unique system and line cleaning solution, ideal for dealing with compressor burn outs, R22 retrofits and equipment upgrades and replacements
- Diversi-Flush™ effectively removes all traces of residual oil and contaminants from the entire system. The easy-to-use kit includes everything needed to quickly and effectively clean through the entire system
- DiversiFlush™ Solvent is a non-Volatile Organic Compound (VOC), residue-free and complies with the Environmental Protection Agency (EPA) and the Significant New Alternatives Program (SNAP) standards
- No pump required
- Low toxicity, non-flammable and residue free
- Fast, easy to use and low cost
- Can be used in any type of equipment
- Self-contained kit with replaceable solvent refills
- High evaporation rate solvent ensures easy and complete removal from the system
- The kit includes a line set adaptor to connect the flow & return lines

Part No	Description	Qty/Pk
GM91047	Diversi-Flush Kit	Each
GM91049	Diversi-Flush Refill	480ml



Pro-Tite Thread Sealant



- Resin based thread sealant
- Impervious to most chemicals including refrigerant
- Adheres to internal surfaces and fills voids
- Forms a flexible, fluid-tight seal

Part No	Description	Size
GMMP68	Pro-Tite Thread Sealant	38ml



Service Spray Bottle

- Hand pump action to charge the bottle
- Hand held lance with adjustable nozzle
- Translucent delivery hose for greater visibility of liquid level
- Safety valve under the rim automatically releases excess pressure
- Robust, but light polypropylene tank
- Large funnel shaped mouth for quick and easy fill



Part No	Description	Size
GMSB2	Service Spray Bottle with Hand Pump	5 Ltr

Microfibre Cleaning Cloth



- Microfibre Cleaning Cloth 30x30cm
- Use for general cleaning and polishing for a smear free finish

Part No	Description	Qty/Pk
GMMP102-4	Microfibre Cleaning Cloth	pk4

Service Spray Bottle - Trigger Spray

- For dispensing diluted chemicals
- Ergonomic Design



Part No	Description	Size
GMSB1	Service Spray Bottle - Trigger Spray	1 Ltr

Blue Centre-feed Roll

- Strong, absorbent paper wipe
- Ideal for mopping spills
- 2 Ply
- 190mm x 125mm



Part No	Description	Qty/Pk
GMBLUCF	Blue Centre-feed Paper Towel	Each

Multi-Purpose Big Wipes

- Pre-impregnated industrial-strength multi-purpose cleaning wipes
- Say goodbye to dirty wet towels and messy liquid cleaners, say hello to a high-performance mobile multi-cleaner that will tackle just about any dirt or stain



Part No	Description	Qty/Pk
GMMP70	Big Wipes - Industrial Hand Wipes	40 Wipes

Ultra Grime Wipes

- 100 huge wipes
- Large, strong & effective on the most stubborn industrial dirt & grime
- Low-foaming, hand & surface safe
- Large absorbency capacity with microfibre-type texture



Part No	Description	Qty/Pk
GMULTRGRIME	Ultra Grime Wipes	100 Wipes

Uniwipe Clinical Sanitising Wipes

- Tested to kill Coronaviruses in 60 seconds including SARS CoV-2.
- Super performance sanitising wipes for everyday commercial and domestic use. Manufactured in the UK from low-lint fabric & able to trap dirt and kill bacteria. As a result, they leave every surface safe and grime-free
- Dual action cleaner and sanitiser



Part No	Description	Qty/Pk
GMULCSW	Clinical Sanitising Wipes	200 Wipes



REWARDS RANGE

NEW products added to our gift voucher range

Receive 1000 points for every £500 spent



From sealant gun holders to paper roll dispensers, the new TradeTidy range is perfect for all you organised engineers that like to keep a tidy van!



Got to www.greenmillac.com/myrewards to check your points and view the whole rewards range

Disposable Overalls



- Light protection from dirt, grease and dust
- Not water resistant
- Elasticated cuffs, ankles and hood
- Front zip
- 100% non-woven polypropylene

Part No	Description	Size	Qty/Pk
GMPPE70	Disposable Overall	L	Each
GMPPE73	Disposable Overall	XL	Each
GMPPE71	Disposable Overall	XXL	Each

KN95 Face Mask



- Adjusts to fit most face shapes and sizes
- Lightweight, single piece, easy fit design
- Low profile allows for wearing with glasses/safety goggles
- These respirators are for single use only

Part No	Description	Qty/Pk
ZZ-N95MASK	KN95 Face Mask	pk2
ZZ-KN95MASK	KN95 Face Mask	pk5
ZZ-N95MASK-20	KN95 Face Mask	pk20

Hi-Vis Waistcoats



- Yellow class 2 polyester waistcoat c/w high vis bands
- Velcro fastening
- Conforms to EN471

Part No	Description	Size
GMPPE61	Class 2 Hi-Vis Waistcoat - Yellow	Large
GMPPE62	Class 2 Hi-Vis Waistcoat - Yellow	XLarge
GMPPE63	Class 2 Hi-Vis Waistcoat - Yellow	XXLarge

Safety Glasses



- Comfortable and stylish spectacle
- Dual technology arms which provide enhanced comfort using both hard and soft materials
- Exceptionally lightweight
- Supplied with a hang cord
- Clear anti-scratch lens

Part No	Description	Qty/Pk
GMPPE42	Safety Glasses	1 Pair

Cut Level 1 Safety Gloves



- Cut Level 1 red safety gloves
- Close fitting for greater dexterity
- Comfortable and breathable
- Durable PU coating
- For dry conditions

Part No	Description	Size	Qty/Pk
GMPPE11	Cut Level 1 TraffiGlove	Size 9	Pair
GMPPE12	Cut Level 1 TraffiGlove	Size 10	Pair

Cut Level 3 Safety Gloves



- Cut Level 3 orange safety gloves
- Enhanced cut resistance
- Close fitting for greater dexterity
- Comfortable and breathable
- Durable PU coating
- For dry conditions

Part No	Description	Size	Qty/Pk
GMPPE13	Cut Level 3 TraffiGlove	Size 9	Pair
GMPPE14	Cut Level 3 TraffiGlove	Size 10	Pair

Black PU Gloves



- Protect against minor cuts and abrasions
- Polyurethane coating on fingers and palms
- Lightweight and close fitting

Part No	Description	Size	Qty/Pk
GMPPE9-12	Black PU Gloves	Size 9	12 Pairs

PVC Gauntlets



- Fully coated PVC Gauntlets for 100% resistance to oil & water
- Tough and flexible
- 450mm long for optimal forearm protection
- Conforms to EN388

Part No	Description	Size	Qty/Pk
GMPPE24	PVC Gauntlets	450mm	Pair

Rothenberger Romax Compact Tool Set c/w Jaws & Accessories

This Rothenberger tool kit is a universal kit for both Hybrid and Braze-free refrigeration jointing systems



- Startup Kit Includes:
- 19kN Press Tool
- Tube Cutter
- Deburring Tool
- Deburring Pencil
- Depth Gauge
- Abrasive Pads
- Permanent Marker
- 18v Battery
- Charger
- Rothenberger set of 8 Jaws 1/4" - 1-1/8" to suit MaxiPro fittings
- Sizes include: 1/4", 3/8", 1/2", 5/8", 3/4", 7/8", 1", 1-1/8"
- 2x Stackable Carry Cases

Part No	Description
GMCXM8	Romax Compact Tool Set with Jaws



Romax Compact Tool Set c/w Battery & Charger (No Jaws)



- 19kN Press Tool
- 18V Battery
- Battery Charger
- Stackable Carry Case

Part No	Description
GMCXM0	Romax Compact Tool Set (No Jaws)

Conex MaxiPro 8 Jaw Set



- Rothenberger set of 8 Jaws 1/4" - 1-1/8" in a stackable carry case to suit MaxiPro fittings
- Sizes include: 1/4", 3/8", 1/2", 5/8", 3/4", 7/8", 1", 1-1/8"

Part No	Description	Size Range
GMCX8JS	Conex MaxiPro Set of 8 Jaws	1/4" - 1 1/8"



Rothenberger Compact Battery



- Patented "AIR COOLED" charging technology
- Processor-controlled charging management system
- Capacity indicator to control the charging level

Part No	Description
GMCXBAT	Rothenberger 18V Spare Battery

Conex MaxiPro Depth Gauge



- MaxiPro depth gauge with marker pen to confirm the proper insertion depth of the tubing into the fittings

Part No	Description
GMCXDG	Conex MaxiPro Depth Gauge & Marker

RLS 19kN Press Tool Kit

This RLS tool kit is a universal kit for both Hybrid and Braze-free refrigeration jointing systems

Purchase this press tool kit and then simply buy the jaws as and when you need them. Then add the Makita charger and battery if required

Startup Kit Includes:

- 19kN RLS Crimping Tool
- Tube Cutter
- Deburring Tool
- Crimp Gauge
- Depth Gauge
- Stainless Steel Brush
- Abrasive Pad
- Permanent Marker



No jaws, batteries or charger included

Part No	Description
GMZLTOOL138-NB	19kN RLS Press Tool Kit & Case

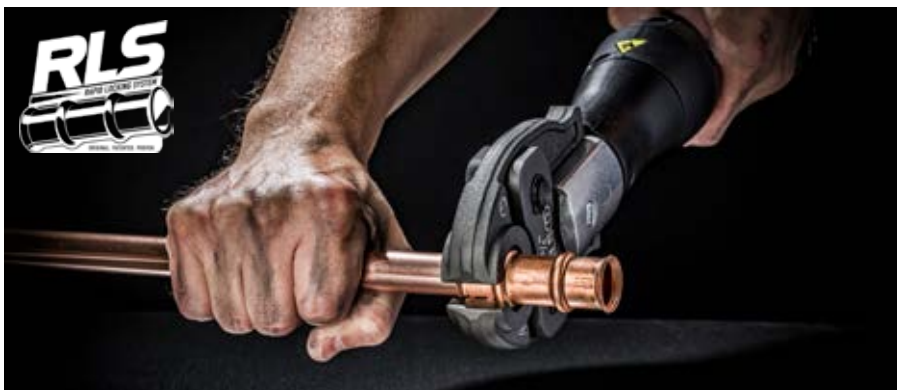

Makita 18V Fast Charger



- Extremely fast charging time

Part No	Description
GMZLCHAR	Makita 18v Battery Charger

Makita 18V Battery



- High performance rechargeable battery

Part No	Description
GMZLBAT15	Makita 18v Rechargeable Battery

19kN RLS Jaws



- Patented concentric crimping jaws
- Applies perfectly even pressure all around the 'o-ring' and copper tube

- Compatible with the 19kN RLS & Rothenberger press tools

Part No	Description	Size
GMZL231	RLS Jaw	¼"
GMZL232	RLS Jaw	¾"
GMZL233	RLS Jaw	½"
GMZL234	RLS Jaw	¾"

Part No	Description	Size
GMZL235	RLS Jaw	¾"
GMZL236	RLS Jaw	¾"
GMZL237	RLS Jaw	1-¾"
GMZL238	RLS Jaw	1-¾"

Copper M Press Fit Jaws



- For copper pressfit system
- 15kN jaws compatible with 15kN press tool
- 19kN jaws compatible with the 19kN RLS & Rothenberger press tools
- M-Profile

Part No	Description	Capacity	Size
GMCPJ16	Copper Pressfit Jaw	15kN	15mm
GMCPJ23	Copper Pressfit Jaw	15kN	22mm
GMCPJ29	Copper Pressfit Jaw	15kN	28mm
GMCPJ15	Copper Pressfit Jaw	19kN	15mm
GMCPJ22	Copper Pressfit Jaw	19kN	22mm
GMCPJ28	Copper Pressfit Jaw	19kN	28mm
GMCPJ35	Copper Pressfit Jaw	19kN	35mm

Barrier Pipe Pressfit Jaws



- For barrier pressfit system
- 15kN Jaws compatible with 15kN press tool
- 19kN Jaws compatible with the 19kN RLS & Rothenberger press tools
- U-Profile

Part No	Description	Capacity	Size
GMUPJ21	Barrier Pressfit Jaw	15kN	20mm
GMUPJ25	Barrier Pressfit Jaw	15kN	25mm
GMUPJ33	Barrier Pressfit Jaw	15kN	32mm
GMUPJ20	Barrier Pressfit Jaw	19kN	20mm
GMUPJ26	Barrier Pressfit Jaw	19kN	25mm
GMUPJ32	Barrier Pressfit Jaw	19kN	32mm
GMUPJ40	Barrier Pressfit Jaw	19kN	40mm

Carry Case for RLS Jaws



Part No	Description
GMZL209	Carry Case for RLS Jaws



- Hard plastic case with foam lining
- Protective storage for full set of 8 jaws (Jaws not included)

Deburring Tool



- Removes any internal or external burrs from copper tube
- RLS approved

Part No	Description
GMZL007	Deburring Tool

Abrasive Pad & Marker Pens



- Abrasive pad for cleaning the copper tubing prior to crimping
- Marks on most surfaces
- Use with the insertion depth gauge to mark the tube

Part No	Description	Qty/Pk
GMZL020	Abrasive Pad	Each
GMPMP	Permanent Marker Pen	pk 6

RLS Crimp Gauge



- Confirms the measurement of the finished crimp band diameter

Part No	Description
GMZL005	RLS Crimp Gauge

RLS Insertion Depth Gauge



- Confirms the proper insertion depth of the tubing

Part No	Description
GMZL014	RLS Insertion Depth Gauge

Rothenberger Tube Cutter



- Contains a spare cutter wheel in the handle
- Features a retractable internal pipe deburrer

Part No	Description	Size
GMTC135	Tube Cutter	For 1/4" 1-3/8" (6-35mm) Ø Tube
GMTC135WC	Spare Wheel	



Javac Edge Tube Cutter



- Automatic cutting using pressure from a spring when cutting
- Titanium blade for a clean cut, minimal deburring
- For 3/8" to 1-1/4" (6mm - 32mm Ø tubing)

Part No	Description	Size
GMTC2	Javac Edge Tube Cutter	3/8" to 1-1/4"



Big Imp Tube Cutter



- Big capacity, small size tube cutter designed for use in tight spaces where other cutters won't fit.
- For 3/8" to 1-1/8" (10mm - 28mm Ø tubing)

Part No	Description	Size
GMTC1001	Big Imp Tube Cutter	3/8" to 1-1/8"



Milwaukee 12 V Cordless C12 Tube Cutter



- Milwaukee® high performance 500 rpm motor cuts ½" copper pipe in less than 3 seconds.
- Auto adjusting jaws – automatically adjusts to pipe size.
- Battery and charger sold separately
- Suitable for cutting copper: ½" - 1 ¼"
- Features LED work light for workspace illumination



Part No	Description
GMMILC12PCO	Milwaukee C12 Tube Cutter Bare Unit

Milwaukee Rapid Charger



- Recharges M12 B2 red Lithium-ion batteries in 28 minutes or less
- Also charges all M12, M14 & M18 red Lithium-ion battery packs

Part No	Description
GMMILM1218FC	Milwaukee Rapid Charger

12V Milwaukee Battery



- Offers up to twice the run time, 20% more power and up to twice the recharges compared to other Lithium-ion technologies

Part No	Description
GMMILM12B2	Milwaukee M12 B2 Red Lithium-ion Battery

Rothenberger Plastic Pipe Cutters



- High quality, Rothenberger plastic pipe cutter
- For precise clean cuts without deforming the pipe

Part No	Description	Size
GMDPC1	Rothenberger Plastic Pipe Cutter	26mm

Rothenberger Barrier Pipe Cutter



Part No	Description	Size
GMDPC2	Rothenberger Plastic Pipe Cutter	42mm

- For cutting up to 42mm pipe
- Instant-release mechanism for minimal effort
- For precise cutting without deformation

Ox Plastic Pipe Cutters



- High quality, plastic pipe cutters

Part No	Description	Size
GMPT22	Ox Plastic Pipe Cutter	¾" (22mm)
GMPT35	Ox Plastic Pipe Cutter	1¼" (35mm)
GMPT42	Ox Plastic Pipe Cutter	1½" (42mm)

Javac Edge Single Size Tube Benders



Part No	Description	Size
GMCH367	Single Size Tube Bender	¾"
GMCH368	Single Size Tube Bender	½"
GMCH369	Single Size Tube Bender	¾"
GMCH370	Single Size Tube Bender	¾"
GMCH371	Single Size Tube Bender	¾"

- Dual hinge design which resets the handle for extra leverage, simplifying the second bend to 180°
- Ergonomic TPR (Thermo Plastic Rubber) handles for comfortable non-slip grip

REMS Curvo Electric Pipe & Tube Bender



- Universal, compact electric tool for cold bending of pipes and tubes up to 180°
- Can be used anywhere, without a vice
- Suitable for many pipe types
- Instant use without setting
- Fast and creep speed operation for precise bending
- Rapid change of bending and back formers
- Specially suited for tubes of pressfitting systems, for hard and half-hard copper tubes and for thin-walled copper heating tubes according to EN 1057

Part No	Description	Size
GMCURVO	Electric Pipe & Tube Bender	110V
GMCURVO118	Former for REMS Bender	1½"
GMCURVO138	Former for REMS Bender	1¾"

Additional sized formers & optional floor stand available to order on our website

Rothenberger Barrier Pipe Bending Tool



- Ratchet action bending tool for Hybrid barrier pipe
- Supplied in carrying case c/w a set of bending inserts
- One-handed mechanism for easy use
- Ideal for producing 90° bends
- A high quality robust tool

Part No	Description	Size
GMUP215	Barrier Pipe Bending Tool	16/20/25 & 32mm

Rothenberger Pipe Bender



- Industrial, portable tube bender
- Easy to use, lightweight and robust
- c/w appropriate formers

Part No	Description	Size
GMPB2	Rothenberger Pipe Bender	15/22mm

Soft Copper Coil Pipe Straighteners



- For straightening soft copper tube
- Efficient, hand held tool
- Fast, simple, straight alignment of copper coils

Part No	Description	Size
GMPS14	Pipe Straightener	¾"
GMPS38	Pipe Straightener	¾"
GMPS12	Pipe Straightener	¾"

Imperial Triple Bender



- Bends 3/16", 1/4", 3/8", 1/2" tubing
- Calibrated for accurate left hand, right hand and offset bends
- Cushion grips for extreme comfort

Part No	Description	Size Range
GMCH375	Imperial Triple Bender	3/16", 1/4", 3/8", 1/2"

Hilmor A Frame Tube Bender



- Imperial version - 2 guides and formers (7/8" and 1-1/8")
- Calibrated markings for making accurate bends up to 180°
- Heavy-duty A-frame for stable working

Part No	Description	Size Range
GMCH386	Hilmor A Frame Bender	3/8", 1-1/8"

Portable Hydraulic Tube Bender



- Suitable for Soft Copper Coils only
- Extremely light body: less than 2kg
- Die cast aluminium and steel pump body with double hydraulic circuit.
- Formers in die-cast aluminium
- Interchangeable counterformers in galvanised steel with diecast aluminium laterals for quick positioning
- Supplied in plastic carry case



Part No	Description	Size Range
HB451	Portable Hydraulic Tube Bender Kit	3/4" to 3/8"

Copper Tube Bending Springs



- Includes 3/4", 3/8", 1/2", 3/4", 3/4" bending springs

Part No	Description	Size Range
GMBSMP	Copper Tube Bending Springs	3/4" to 3/4"



Barrier Pipe Outside Bending Spring



- For bending 25mm Ø Barrier pipe externally
- Ensures an even bend without kinks

Part No	Description	Pipe Size
GMUP212	Outside Bending Spring	25mm Ø

Barrier Pipe Inside Bending Spring



- For bending 25mm Ø Barrier pipe internally
- Ensures the bore diameter is maintained when bending

Part No	Description	Pipe Size
GMUP211	Inside Bending Spring	25mm Ø

Easybend Line Set Bender Kit



- Avoid kinks in copper refrigerant tubes by using the Easybend Kit
- Suitable for four sizes of soft copper refrigerant tube:
- 1/4", 3/8", 1/2" & 5/8"
- Colour-coded for easy identification
- No need for springs or heavy and expensive equipment.
- Easily retracted and very flexible
- Reusable, with resealable straps
- Easybend is a quick and easy way to bend soft copper tubes

Part No	Description	Sizes
GMLSB	Easybend Line Set Bender Kit	3/4" 3/8" 1/2" 5/8"



Javac Edge Tube Expander Set



- The only set available complete with a 3/4" expander head
- Ergonomic TPR (Thermo Plastic Rubber) handles for comfortable non-slip grip
- Eight heads for precision and consistency - 3/4", 3/8", 1/2", 5/8", 3/4", 7/8", 1", 1-1/8"
- c/w durable plastic carry case



Part No	Description	Size Range
GMES10	Javac Edge Expander Set	3/4" to 1-1/8"

Rothenberger Tube Expander Set

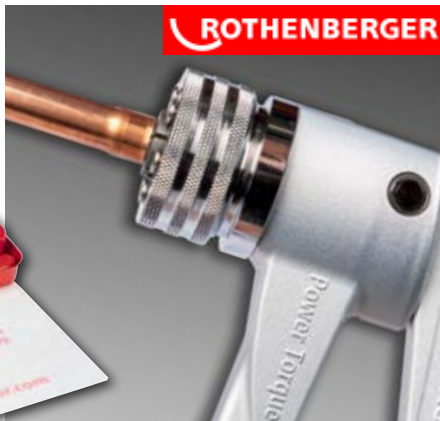

- c/w 6 expander heads & reamer

- Precision capillary socket forming tool for the production of end feed brazing joints in copper tube
- Tough, light and wear-resistant
- Creates quality pipe connections in accordance with DVGW standards
- Eliminates the cost of purchase and storage of fittings
- Reduces labour needs, brazing materials, joints and energy use by 50%
- Supplied in steel carrying case

Part No	Description	Size Range
GMCH1020	Rothenberger Tube Expander Set	3/8" to 1-1/2"

Tube Expander Heads



- Interchangeable with a variety of expanders
- Tough and long-lasting

Part No	Description	Size
GMCH14	Tube Expander Head	1/4"
GMCH38	Tube Expander Head	3/8"
GMCH12	Tube Expander Head	1/2"
GMCH58	Tube Expander Head	3/8"
GMCH34	Tube Expander Head	3/4"

Part No	Description	Size
GMCH78	Tube Expander Head	3/4"
GMCH118	Tube Expander Head	1-1/8"
GMCH138	Tube Expander Head	1-3/8"
GMCH158	Tube Expander Head	1-5/8"

Deluxe Flaring Tool



- Clutch type flaring tool
- The eccentric cone and ratchet clutch produce perfect flares
- c/w tough plastic carry case



Part No	Description	Size Range
GM708AL	Deluxe Flaring Tool & Case	1/4" to 3/4"

Mastercool 45° Flaring & Swaging Tool



- Quality flaring and swaging tool set for sizes from 3/16" to 3/4"
- Durable forged steel slip-on yoke
- Bars are chrome-plated hardened steel
- Swages in close quarters where punch style cannot be used
- Supplied in plastic carry case

Part No	Description
GM70053	Mastercool 45° Flaring & Swaging Tool Set

RLS Deburring Tool



- Removes any internal or external burrs from copper tube
- RLS approved

Part No	Description
GMZL007	RLS Deburring Tool



Mastercool Pencil Deburrer



- Designed to remove inner burrs easily
- Full metal grip
- Includes one spare tungsten blade

Part No	Description
GM71685	Mastercool Pencil Deburrer
GM71686	2x Tungsten Spare Blades

3 in 1 Barrier Pipe Beveling Tool



- To ensure a uniformly round bevel for easy connections

Part No	Description	Size
GMUP216	3 in 1 Barrier Pipe Beveling Tool	16/20/25mm
GMUP217	3 in 1 Barrier Pipe Beveling Tool	20/25/32mm

Barrier Pipe Beveling Tool



Part No	Description	Size
GMUP209	Barrier Pipe Beveling Tool	20mm
GMUP210	Barrier Pipe Beveling Tool	25mm
GMUP213	Barrier Pipe Beveling Tool	32mm
GMUP214	Barrier Pipe Beveling Tool	40mm



- To ensure a uniformly round bevel for easy connections
- Use with the handle provided or with a drill for speed

Rothenberger Super Fire 2 Brazing Torch



- Concentrated, high heat, anti flare, adjustable flame
- Turbine flame pattern
- Instant Piezo ignition
- Can be used at any angle
- Use with any Map or Propane disposable cylinders

Part No	Description
GMBZT2	Rothenberger Super Fire 2 Brazing Torch



Rothenberger Double Barrel Turbo Brazing Torch

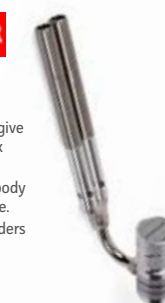

- Twin stainless steel torch burners give added strength and increased max working temperature.
- Durable nickel-plated brass valve with easy turn fine regulating valve.
- Fits both Map & propane gas cylinders
- Double barrel flame for larger coverage
- Will braze up to 3" copper

Part No	Description
GMBZT3	Rothenberger Double Barrel Turbo Brazing Torch



Heat Deflector Guard



- Used to prevent the scorching of walls, skirting boards and other surfaces whilst brazing
- Compatible with Super Fire 2 & Double Barrel brazing torches

Part No	Description
GMBZT6	Heat Deflector Guard

Brazing Mat & Fire Extinguisher



- Will withstand 1000 °C
- Can be used with Turbo type torches

- Suitable for A: Wood, paper and textiles, B: Liquid fires, such as petrol, oil and paints & C: Flammable gases & electrical fires
- Suitable for use in vehicles
- Easy to mount on a wall with bracket and strap

Part No	Description
GMBZA2	Insurance Rated Brazing/Soldering Mat
GMFE2	2kg Powder Fire Extinguisher

Portapak Brazing Kit

Kit Contains:

- Acetylene regulator single stage 2 gauge
- Oxygen regulator single stage 2 gauge
- Acetylene and oxygen flashback arrestors
- 5mt oxy/acetylene hoses
- Brazing torch
- 3 brazing nozzles
- Safety goggles
- Cylinder key
- Fixed height trolley
- Robust welded steel design
- Solid tyres



Part No	Description
GMBZT8	Portapak Brazing Kit c/w Trolley

Portapak Brazing Nozzles



- For use with the Portapak brazing kit
- Lightweight high performance copper

Part No	Description	Size
GMBZT17	Portapak Brazing Nozzle	No. 7
GMBZT18	Portapak Brazing Nozzle	No. 10
GMBZT19	Portapak Brazing Nozzle	No. 13

Turbo Set 1000 Portable Brazing Kit

Gas bottles see page 85



- Sturdy portable brazing kit weighing only 5kg
- 2 metre hoses fitted with blow back valves
- Maxy Gas Oxygen combination which attains temperatures up to 3050°C
- Kit complete with welding goggles, lighter, spanner and brazing rods
- Cylinders included

Part No	Description
GMBZT7	Turbo Set 1000 Portable Brazing Kit

Heat Shield - Heat Blocking Compound



- Apply, remove and reuse – up to 40 times!
- Handy colour changing putty shows you when you need to replace the pot



- Reusable alternative to wet ragging

Part No	Description	Size
GMBZA10	Heat Shield - Heat Blocking Compound	340g

Mastercool Accu-Charge Scales



- Suitable for all types of refrigerants
- Rugged die-cast aluminium construction
- c/w tough ABS case
- 9V battery included
- 110kg capacity
- 0.1% accuracy



Part No	Description	Capacity
GM98210	Mastercool Accu-Charge Scales	110 kg

Nitrogen Trolley



- Retractable handle cylinder trolley
- Cylinder not included

Part No	Description	Qty/Pk
GMNT	Nitrogen Trolley	Each

Pro Charge Weighing Scales



- 25 x 25cm platform
- 30 hours continuous use
- 9v Battery
- Units kg/Lb
- Very high accuracy +/- 0.5%
- 100kg weight capacity

Part No	Description	Capacity
GMPC100	Pro Charge Weighing Scales	100kg

Wireless Charging Weighing Scales



- Base unit includes weighing platform, 4x AA batteries & plastic carry case
- Weighing capacity - 250 lb. (115kg)
- Accuracy +/-0.06% of reading, +/- 0.25 oz (10g)
- Control - Menus and buttons in app interface / touch screen
- Display - User-provided smartphone (iPhone 4S and above or Android 2.2 and above)
- Wireless range - 30 ft

Part No	Description	Capacity
GMWT115	Wey-Tek Wireless Charging Scales	115 kg

Cylinder Heating Belt - 110V



- Heats cylinders to 50°C to increase the pressure of the refrigerant
- Speeds up recharging time
- Assures total discharge of refrigerants from cylinders
- 300W heater element

Part No	Description	Voltage
GMCHB110	Cylinder Heating Belt	110V

Bosch Recovery Units RG4.0



A2L Compliant



- Suitable for all commonly used refrigerants and A2L mildly flammable refrigerants such as R32 & R1234YF
- Maximum operating pressure of 38.5 bar/550psi
- For use when repairing or performing maintenance of AC systems

Part No	Description	Voltage	Weight	Liquid Recovery	Vapour Recovery	Push/Pull
GMRG4-110	Bosch Recovery Unit	115V	14.6 kg	122 kg/hour	10.7 kg/hr	410 kg/hr
GMRG4-240	Bosch Recovery Unit	230V	14.6 kg	122 kg/hour	10.7 kg/hr	410 kg/hr

Promax Minimax Recovery Units



A2L Compliant



- Recovers all commonly used refrigerants including R410A
- Minimum size - maximum performance
- Unique oil-less compressor capable of handling liquid
- Ergonomic design for easier handling

Part No	Description	Voltage	Weight	Liquid Recovery	Vapour Recovery	Push/Pull
GMMAX110	Promax Minimax Recovery Unit	115V	11 kg	90 kg/hour	9 kg/hr	354 kg/hr
GMMAX240	Promax Minimax Recovery Unit	230V	11 kg	90 kg/hour	9 kg/hr	354 kg/hr

Promax Recovery Units RG3000



A2L Compliant



- Suitable for all commonly used refrigerants and A2L mildly flammable refrigerants such as R32 & R1234YF
- Incredibly compact taking up minimal van space
- Lightweight and easy to handle
- Robust and oil-less compressor for great performance
- Unique vibration isolating features

Part No	Description	Voltage	Weight	Liquid Recovery	Vapour Recovery	Push/Pull
GMRG3000A	Promax Recovery Unit	115V	8 kg	58.25 kg/hour	8.18 kg/hr	229 kg/hr
GMRG3000B	Promax Recovery Unit	230V	8 kg	58.25 kg/hour	8.18 kg/hr	229 kg/hr

Javac Edge XTR Pro Recovery Unit



A2L Compliant



- Suitable for R32, R1234YF, HFC/HCFC/CFC/A2L, Standard refrigerants
- Spark proof design: 5 m hard wired cable
- Dual voltage - switch easily to 115 V or 230 V 50 Hz (Supplied with 230V plug/lead only)
- Integrated circuit breaker protection
- X-Connect technology protects against incorrect voltage
- HP cut out 500 psi (35 bar)
- Oil-less compressor
- Dimensions 420 x 290 x 420 mm
- 110V lead separately available (GMEA38)

Part No	Description	Voltage	Weight	Liquid Recovery	Vapour Recovery	Push/Pull
GMXTR	Javac Edge Recovery Unit	Dual 115V / 230V	12 kg	90 kg/hr	15 kg/hr	300 kg/hr
GMEA38	Kettle Lead Accessory	110V				

Fieldpiece Digital Recovery Unit



A2L Compliant



- Minimizes liquid slugging and maximizes vapour recovery
- Easy access ports
- Water resistant to withstand direct rain
- Protects from voltage drop (runs as low as 95 VAC)
- Single dial self purge
- Extra large condenser cools faster, especially on hot days
- Easy access ports
- Easy hose connections and built in power cord storage
- Large backlit display with status messages
- A2L ready including R32

Part No	Description	Voltage	Weight	Liquid Recovery	Vapour Recovery	Push/Pull
GMFPMR45	Fieldpiece Digital Recovery Unit	230V	10 kg	336 kg/hr	19.8 kg/hr	432 kg/hr
GMFPMR45-110	Fieldpiece Digital Recovery Unit	110V	10 kg	336 kg/hr	19.8 kg/hr	432 kg/hr



Robinair Vacuum Pump



- High quality 6CFM vacuum pump
- Two stage design
- Second stage starts pumping at a lower pressure to pull a deeper ultimate vacuum
- Offset rotary vanes
- Proven design creates the deep vacuum conditions needed for a thorough evacuation
- Gas ballast feature - helps keep the pump oil clean by reducing condensation of moisture
- Iso-Valve isolates pump from the system with just a ¼ turn, making it simple to measure rate of rise
- Plug not included
- Not A2L compliant



Part No	Description	Voltage
GM15601	Robinair Vacuum Pump	Dual 110V/240V

Robinair Vacuum Pump A2L



- High vacuum rating - The two-stage rotary vane design provides powerful, quiet, high vacuum capability, and ensures moisture removal while the high pumping capacity reduces evacuation time.
- Gas ballast feature - helps keep the pump oil clean by reducing condensation of moisture.
- Free air displacement: 128 l/m
- Ultimate vacuum: 15 microns (2pa)
- Oil capacity: 500ml
- CFM: 5
- Oil included
- A2L / R32 ready
- May be used on ammonia



Part No	Description	Voltage
GM15501A2L	Robinair A2L Vacuum Pump	240V

Vacuum Pump Oil

- Premium quality Vacuum Pump Oil
- Specially formulated to improve cold start performance on most high performance vacuum pumps; chemically engineered to maintain viscosity at very high running temperatures



Part No	Description	Size
GMVP01	Vacuum Pump Oil	1ltr

Fieldpiece Dual Voltage Vacuum Pump



- RunQuick™ Oil Change System
- Change oil in seconds whilst pump is running
- In-line four port manifold for easy access
- Backlit oil reservoir to view condition of oil and system
- Gas ballast feature
- Cast iron pump body
- 6CFM
- Easy to use hose valve ports keeps hoses in line
- 110V lead separately available (GMEA38) See page 221

Part No	Description	Voltage
GMFPVP55	Fieldpiece Vacuum Pump	Dual 110V/230V

Rothenberger Cordless Vacuum Pump



- Battery driven 2-stage vacuum pump
- Brushless motor
- 18V cordless battery
- ¼" standard connection
- Perfect for mobile usage on roofs
- c/w 18V battery charger
- Gas ballast feature

Part No	Description	CFM
GMRV2	Rothenberger Cordless Vacuum Pump	2.0
GMRV5	Rothenberger Cordless Vacuum Pump	5.0



Mastercool 2-Way Manifold



- c/w 72" ball valve hose set
- c/w plastic carry case
- Requires 2x R410A adapters when using for R410A

Part No	Description	Suitable For
GM57272	Mastercool 2-Way Manifold	R22, R407C & R410A

Mastercool 4-Way Manifold



- c/w 72" ball valve hose set
- c/w 3/8" black vacuum hose
- c/w plastic carry case
- Requires 2x R410A adapters when using for R410A

Part No	Description	Suitable For
GM96272	Mastercool 4-Way Manifold	R22, R407C & R410A

2-Way R410A/R32 Manifold



- 2-valve manifold (no sight glass)
- 3/4" SAE connection
- c/w 3x 72" hoses - red, blue & yellow
- Scale readings in BAR, PSI °F & °C
- c/w carry case

Part No	Description	Suitable For
GMBM25	2-Way Manifold Without Sight Glass	R410A/R32

2-Way Refco Clim Manifold

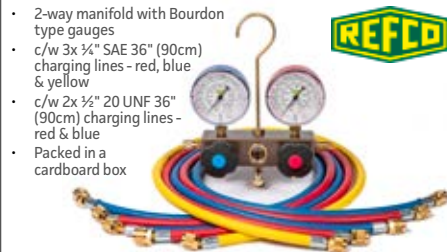

- 2-way manifold with Bourdon type gauges
- c/w 3x 3/4" SAE 36" (90cm) charging lines - red, blue & yellow
- c/w 2x 1/2" 20 UNF 36" (90cm) charging lines - red & blue
- Packed in a cardboard box



Part No	Description	Suitable For
GMBM2A	2-Way Refco Clim Manifold	R22, R407C & R410A

Single High Pressure Manifold



- One-way manifold supplied with high pressure gauge and hook
- Max 54 Bar

Part No	Description	Suitable For
GMVG1	Single Manifold with High Pressure Gauge	

Testo Smart Digital Manifold Kit



- App-controlled digital manifold with Bluetooth.
- 2-way valve block and sturdy hook.
- 2x 115i wireless clamp thermometers (Bluetooth, NTC) and a robust carry case.

Part No	Description
GMT550i	Testo Smart Digital Manifold Kit

Absolute Vacuum Torr Gauge



- 100mm diameter gauge
- 1/4" flare connection (MFL)

Part No	Description	Range
GMVG12	Absolute Vacuum Torr Gauge	0 - 40 Torr

Nitrogen Regulator (50 Bar)



- Quality single stage two gauge heavy duty regulator
- 3/4" SAE male outlet

Part No	Description
GMNR2-A	50 Bar Nitrogen Regulator

Testo Smart Manifold Vacuum Kit



- Digital manifold with Bluetooth
- 4-way valve block features a large graphic display, a compact, robust housing, guided measurement menus & the Testo Smart App.
- Top-quality measurement technology, a high degree of reliability and smart functions for quick, easy measurements and documentation make the Testo 557s manifold a reliable partner for your commissioning, servicing and maintenance of refrigeration and air conditioning systems and heat pumps.

Part No	Description
GMT557	Testo Smart Manifold Vacuum Kit c/w Bluetooth

Digital Vacuum Torr Gauge & Probe



- Digital vacuum measuring instrument with Bluetooth
- For wireless monitoring of measurement results
- Use the GMT552i vacuum probe with Bluetooth to measure vacuum wirelessly with speed, ease and precision via just one service port - with no loss of refrigerant.

Part No	Description	Range
GMT552	Digital Vacuum Torr Gauge	0 - 26 mbar/20,000 mic
GMT552i	Wireless Vacuum Probe	0 - 26 mbar/20,000 mic

Javac Edge Safe Seal Hose Sets

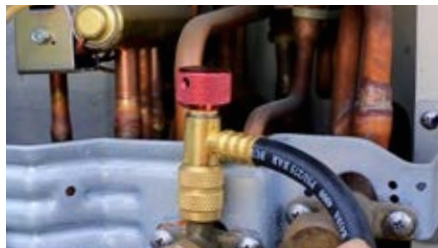

Part No	Description	Size
GM1272S	Safe Seal Hose Set 72" (1.8mt) Long	¼" x ¼"
GM1272RS	R410A/R32 Safe Seal Hose Set 72" (1.8mt)	¼" x ⅜"

- 'One-Touch' design allows you to screw the fitting on to the system before starting refrigerant flow, avoiding refrigerant loss and risk of 'refrigerant burn'. Simply turn the knob to start/stop flow.
- The safety swivel sleeve allows free rotational movement of the hose without the fitting coming loose, preventing leaks.

Charging Hose Set



- Set of 3 - Red, Yellow & Blue
- Rubber seals

Part No	Description	Size
GM1272	Charging Hose Set 72" (1.8mt) Long	¼" x ¼"

R410A/R32 Charging Hose Set



- Set of 3 - Red, Yellow & Blue
- Charging hose set suitable for R410A and R32
- Teflon seals

Part No	Description	Size
GM1260R	Charging Hose Set 60" (1.5mt Long)	¼" x ⅜"

Charging Hose Set c/w Ball Valves



- Set of 3 - Red, Yellow & Blue
- c/w ball valves
- Rubber seals

Part No	Description	Size
GM1272BV	Charging Hose Set 72" (1.8mt) Long	¼" x ¼"

R410A/R32 Hose Set c/w Ball Valves



- Set of 3 - Red, Yellow & Blue
- c/w ball valves
- One end ¼" straight connector and the other end ⅜" angle bend

Part No	Description	Size
GM1272RBV	Charging Hose Set 72" (1.8mt) Long	¼" x ⅜"

R410A Flexible Adapter



- Swivel Connection
- ¼" MFL x ½" -20 UNF-FLL
- Convert ¼" SAE Hose into ⅜" SAE

Part No	Description	Size
GM4931	Flexible R410A Adapter	⅜" Female x ¼" MFL

R410A Flexible Ball Valve Adapter



- Flex Adapter with Ball Valve
- Convert ¼" SAE Hose into ⅜" SAE
- ½"-20 UNF swivel connection for R410A

Part No	Description	Size
GM4911	Flexible R410A BV Adapter	⅜" Female x ¼" MFL

Straight Quick Couplers



- Quick coupler for charging hoses
- Straight coupler

Part No	Description	Size
GMQCS	Straight Quick Coupler	¼"
GMQCSR	Straight Quick Coupler	R410A

90° Quick Couplers



- Quick coupler for charging hoses
- 90° elbow

Part No	Description	Size
GMQCE	90° Quick Coupler	¼"
GMQCER	90° Quick Coupler	R410A

R32 Bottle Adapter



- Brass
- c/w a washer seal
- Left hand thread

Part No	Description	Qty/Pk
GMRT32A	R32 Bottle Adapter	Each

Valve Core Remover/Installer



- Sturdy ball valve design controls refrigerant flow with 1/4 turn of the valve lever.
- Lever position also gives visual indication of whether valve is opened or closed
- ¼" service port

Part No	Description	Qty/Pk
GM3930	Valve Core Remover	Each

Javac D-Tek 3 Leak Detector



- Sensitivity: 1 g/year sensitivity per EN14624
- Detects: All HCFCs, HFCs, HFOs, blends (inc. A2Ls), ammonia, and SF6
- Op temp: -20°C to 50°C (-4°F to 122°F)
- Power: Rechargeable Lithium Ion Battery with USB charging cable
- Battery life: ~10 hours
- Display: LED visual and audible
- In the box: 1 x D-TEK 3, 1 x Infrared sensor, 1 x Lithium ion rechargeable battery, 2 x Spare filters, 1 x AC, wall charger



Part No	Description	Qty/Pk
GMDTLD3	D-Tek 3 Leak Detector	Each

Javac Tek Mate Leak Detector



- Sensitivity CFCs, HCFCs, HFCs
- R22: 2g/yr, R410A: 5g/yr
- Sensor technology Heated diode
- Operating temp. -20°F to 122°F -27°C to 50°C
- Power 2 D-size (1.5-volt) alkaline batteries
- Battery life 16 hours
- Display Visual LED
- Weight 700g
- In the box Sensor, 2 D-size alkaline batteries, spare filters, hard carrying case



Part No	Description	Qty/Pk
GMDTMLD	Tek Mate Leak Detector	Each

Mastercool Electronic Leak Detector



- Visual leak level indicator
- Detects leaks as small as 3g/year
- Suitable for use with most refrigerants including R32
- Three levels of sensitivity
- Five levels of detection
- 2x C Batteries (supplied)
- Supplied in a moulded plastic carry case



Part No	Description	Qty/Pk
GM55100	Raptor Electronic Leak Detector	Each

EcoTemp Alarm Probe Thermometer



- Large, easy to read display
- Audible and visual high/low alarm
- Range -50°C to +200°C
- Max/min, hold & °C/°F functions
- 2 x AAA Batteries (supplied)

Part No	Description	Qty/Pk
GM810960	EcoTemp Probe Thermometer	Each

Temperature Measuring Instrument



- 1-channel temperature measuring instrument TC type K
- Audible alarm
- Measuring range -50°C to +1000°C
- c/w calibration protocol and batteries

GMTKAP - Required for use

- Robust air probe
- TC Type K
- 1.2m cable



Part No	Description	Qty/Pk
GMT925	Temperature Measuring Instrument	Each
GMTKAP	Air Probe for GMT925	Each

Infrared Thermometer



- c/w Bluetooth - Smartphone operated
- Non-contact surface temperature measurement
- Range: -50°C to +150°C



NOTE: Phone not included

Part No	Description	Qty/Pk
GMT8051	Infrared Thermometer	Each

Clamp Thermometer



- c/w Bluetooth Smartphone operated
- Range: -40°C - +150°C
- Suitable for pipes of 6mm - 35mm diameter
- Also for calculating superheating/subcooling



Part No	Description	Qty/Pk
GMT1151	Clamp Thermometer	Each



High Pressure Measuring Instrument



- Hoseless high and low pressure measurement
- Low refrigerant loss when testing systems
- Range: -1 to +60 bar
- c/w Bluetooth - Smartphone operated



NOTE: Phone not included

Part No	Description	Qty/Pk
GMT5491	HP Gauge operated via Smartphone	Each

Humidity Measuring Instrument



- Air humidity/temperature measurement
- Also for calculating cooling/heating performance
- Range: -20°C to +60°C
- 0-100 % relative humidity
- c/w Bluetooth - Smartphone operated



Part No	Description	Qty/Pk
GMT6051	Humidity Measuring Instrument	Each

Vane Anemometer



- Airflow velocity/temperature, volume flow measurement
- Also for calculating cooling/heating performance
- -20°C to +60°C
- Range: 0.4 - 30m/s
- c/w Bluetooth - Smartphone operated



NOTE: Phone not included

Part No	Description	Qty/Pk
GMT4101	Vane Anemometer	Each

Funnel Set Vane Anemometer



- Measure flow, volume flow & temperature
- Flow direction detection
- Multipoint & timed mean calculation
- Includes calibration protocol & batteries
- Plate outlets 200mm Ø
- 330 x 330mm for fans



Part No	Description	Qty/Pk
GMT417	Funnel Set Vane Anemometer	Each

Testo Digital Multimeter



- For measuring voltage, current & resistance
- Digital multimeter for automatic recognition of measurement parameter/range
- Large, illuminated LCD for optimum legibility

Part No	Description	Qty/Pk
GMT760	Testo Digital Multimeter	Each

Testo Clamp Meter - Bluetooth



- Unique grab mechanism for tight measuring points
- Use via Bluetooth with Testo smart probes app & smartphone / tablet
- AC/DC voltage
- Range: 1mV – 600V
- AC/DC Current 0.1 – 600 Amp

Part No	Description	Qty/Pk
GMT770	Testo Clamp Meter - Bluetooth	Each

Testo Non Contact Voltage Tester



- Voltage range up to 1,000 V
- Waterproof and dustproof according to IP 67
- Adjustable for phase detection or voltage indication
- Visual and acoustic signal
- The testo 745 non-contact voltage tester is ideally suited for fast initial checking of any suspected fault sources. It filters high-frequency interference signals and has a two-stage sensitivity setting.

Part No	Description	Qty/Pk
GMT745	Testo Non Contact Voltage Tester	Each

Fieldpiece Joblink Wireless System Charge & Air Kit

Fieldpiece



- Take a full system snapshot quickly and easily
- Kit consists of 2 pressure probes, 2 pipe clamps, and 2 psychrometers in a quick access padded case.
- All measurements can be sent up to 1000' away directly to your mobile device with the Job Link® System mobile app.
- Includes 2x AAA Batteries
- Water Resistant: Designed to IP55

Part No	Description	Qty/Pk
GMFPJL3KH6	Joblink Wireless System Charge & Air Kit	Each

Universal Multi-Fit Fan Motors

- Universal, multi-fit fan motors are ideal for replacement in nearly all industrial and commercial refrigeration and ventilation equipment
- 1mt power cord
- ROHS compliant



Part No	Description	Power
GMFM10W	Multi-Fit Fan Motor	10w
GMFM18W	Multi-Fit Fan Motor	18w
GMFM25W	Multi-Fit Fan Motor	25w

Fin Comb



- Cleans and straightens condenser and evaporator fins with six fin straightener sizes: 8,9,10,12,14 & 15 fins per inch
- Compact 4" length

Part No	Description	Qty/Pk
GMCH351	Fin Comb	Each

Inspection Mirror



- Telescopic inspection mirror with swivel head and pocket clip
- Two swivel joints enable you to fasten the mirror in different positions and at any angle

Part No	Description	Lens Size	Length
GMIR55	Inspection Mirror	55mm Ø	125mm – 560mm

Paint Brush



- Synthetic bristles
- Metal bristle clamp

Part No	Description	Size
GMHS36	Paint Brush	1 ½"

LED Work Light

- Wide light spread
- 400 lumens
- Magnetic base for hands free use
- Requires 3 x AA batteries (not supplied)



Part No	Description	Qty/Pk
GMHS6	LED Work Light	Each

Batteries



- Duracell Plus Alkaline

Part No	Description	Qty/Pk
GMDB1	AAA Batteries	pk 4
GMDB2	AA Batteries	pk 4
GMDB5	9V Battery (PP3)	Each

SDS+ Drill Bits



- SDS+ shank
- Carbide Tip (TCT)
- Used for drilling into masonry such as brick and concrete

Part No	Description	Size
GMSD15	SDS+ Drill Bit	5.0 x 160mm
GMSD1	SDS+ Drill Bit	5.5 x 160mm
GMSD9	SDS+ Drill Bit	6.0 x 160mm
GMSD2	SDS+ Drill Bit	7.0 x 160mm
GMSD3	SDS+ Drill Bit	8.0 x 160mm
GMSD4	SDS+ Drill Bit	10.0 x 160mm
GMSD5	SDS+ Drill Bit	12.0 x 160mm
GMSD6	SDS+ Drill Bit	14.0 x 160mm
GMSD7	SDS+ Drill Bit	16.0 x 210mm
GMSD8	SDS+ Drill Bit	18.0 x 200mm

SDS Drill Bit with Stop



- Allows you to drill to the correct depth for wedge anchors every time
- Only suitable for M8 wedge anchors (GMFX10 & GMFX18)
- Not for M10 wedge anchors

Part No	Description	Size
GMSD20	SDS Drill Bit c/w Stop	10.0mm x 30mm Depth

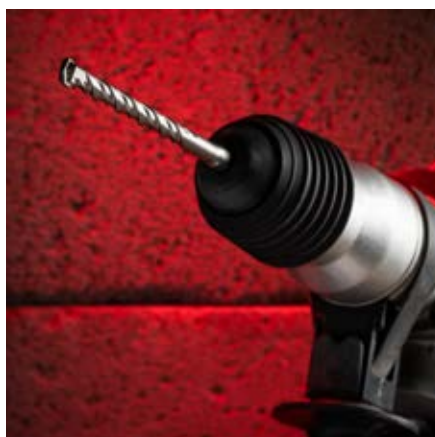

HSS Ground Twist Drill Bits



- Industrial quality, for superior strength

Part No	Description	Size	Qty/Pk
GMHSS4.0	HSS Drill Bit	4.0mm	pk 10
GMHSS5.0	HSS Drill Bit	5.0mm	pk 10
GMHSS6.0	HSS Drill Bit	6.0mm	pk 10
GMHSS7.0	HSS Drill Bit	7.0mm	pk 10
GMHSS8.0	HSS Drill Bit	8.0mm	pk 10
GMHSS10.0	HSS Drill Bit	10.0mm	pk 5
GMHSS11.5	HSS Drill Bit	11.5mm	pk 5
GMHSS12.0	HSS Drill Bit	12.0mm	pk 5
GMHSS13.0	HSS Drill Bit	13.0mm	pk 5

HSS 19pc Drill Bit Set



- 0.5mm increments
- General purpose, for drilling metal, wood and PVC

Part No	Description	Size
GMHS18	HSS 19 Piece Drill Bit Set	1 - 10mm

Holesaw Arbors & Pilot Drill



- For use with standard holesaws including bi-metal holesaws
- Fits standard chucks

Part No	Description	Size
T3206	Holesaw Arbor c/w Pilot Drill	14mm - 30mm
T3207	Holesaw Arbor c/w Pilot Drill	32mm - 210mm
T32092	HSS Pilot Drill Bit	¼"

9 Piece Holesaw Set



- Holesaw kit contains:
- 7 Holesaws - 19mm, 22mm, 29mm, 38mm, 44mm, 51mm & 57mm
 - 2 x Hexagon Arbors ⅜" & ½"

Part No	Description
GMHS35	9 Piece Holesaw Set

Holesaws



- HSS Premium cobalt bi-metal holesaws
- Smooth, fast cutting action
- 38mm cutting depth
- 8% Cobalt for resistance & long life
- Suitable for wood, plastic, cast iron, brass, stainless steel, steel & aluminium

Part No	Description	Size
T20M	Holesaw	20mm
T25M	Holesaw	25mm
T32M	Holesaw	32mm
T38M	Holesaw	38mm
T40M	Holesaw	40mm

Part No	Description	Size
T44M	Holesaw	44mm
T51M	Holesaw	51mm
T54M	Holesaw	54mm
T64M	Holesaw	64mm
T76M	Holesaw	73mm
T105M	Holesaw	105mm

Dry Diamond Cores



Part No	Description	Size
BM65	Dry Diamond Core	65mm
BM78	Dry Diamond Core	78mm
BM102	Dry Diamond Core	102mm

SDS Adapter Pack



- High grade steel
- Easily fitted into an simple spring loaded chuck
- c/w adapter, guide and drift

Part No	Description
BM2	SDS Adapter Pack

Abrasive Metal Cutting Disc



- High quality discs for use on metal
- Compatible with a wide variety of grinders

Part No	Description	Size	Qty/Pk
GMHS44-10	Metal Cutting Disc	115mm x 1.0mm x 22mm Bore	pk 10

TCT Blades for Metal Cutter



- TCT tipped
- To suit cordless metal cutters
- Suitable for cutting construction steel, channel and various metal sections

Part No	Description	Size
GMSTD10	TCT Saw Blade	136mm Ø x 20mm Bore x 32Z
GMSTD12	TCT Saw Blade	165mm Ø x 20mm Bore x 40Z

Studding Cutter

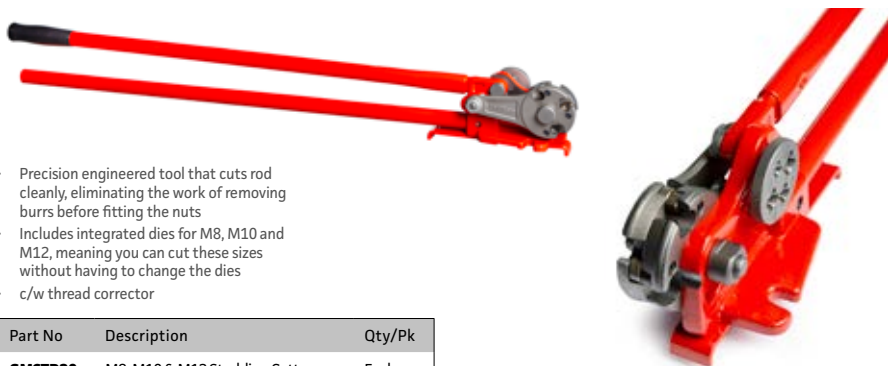

- Precision engineered tool that cuts rod cleanly, eliminating the work of removing burrs before fitting the nuts
- Includes integrated dies for M8, M10 and M12, meaning you can cut these sizes without having to change the dies
- c/w thread corrector

Part No	Description	Qty/Pk
GMSTD20	M8, M10 & M12 Studding Cutter	Each

Jigsaw Blades



- HSS Fully hardened quality for cutting harder materials such as metal, aluminium and non ferrous metals.
- T-shaped shank suitable for most popular jigsaws

Part No	Description	Qty/Pk
GMHS48	T118A Jigsaw Blades	pk 5

12" Hacksaw Blades



- 24 Tpi
- Bi-metal
- 12" (300mm long)

Part No	Description	Qty/Pk
GMHS4	12" Bi-Metal Hacksaw Blades	pk 10

STÖRNCH 3-in-1 Knife



- 3-in-1 Safety Knife
- Fast and simple blade change
- Spring action blade for safe & rapid box opening
- Integrated strapping cutter
- Fixed action blade feature
- Secure tether point
- 3 spare blades within the handle

Part No	Description	Qty/Pk
GMHS65	STÖRNCH 3-in-1 Knife	Each

Trimming Knife



- Robust folding pocket-size trimming knife
- Blade locking system with quick change function
- Dual blades for varied uses
- Spring belt clip

Part No	Description	Qty/Pk
GMHS5	Trimming Knife	Each

Stanley Knife Blades



- For GMHS65, GMHS5 & all standard Stanley knives
- Heavy duty general purpose blade
- Ideal for carpet, vinyl and other sheet material

Part No	Description	Qty/Pk
GMHS2	Stanley Knife Blades	pk 10

Insulation Slitting Knife



- Specially designed by Armaflex as a tool for their products
- The rounded bar in front of the blade ensures a clean, constant cut, but stops the knife cutting into the pipe

Part No	Description
GMEU96	Insulation Slitting Knife

Wire Rope Cutter



- High leverage with hook blades
- Spring-loaded handles with vinyl grips and safety lock
- No more frayed ends!

Part No	Description	Qty/Pk
GMVX112	Wire Rope Cutter	Each

Cable Cutters



- Special alloy steel construction, with induction hardened cutting edges
- Special profile blade for effective cable cutting & wire stripping
- Suitable for copper & aluminium wire only

Part No	Description	Size
GMHS7	Cable Cutters	9 ½"

PZ2 (Pozi) Impact Driver Bits



- Pozi drive #2
- 25mm long
- Standard 3/4" hex
- Excellent wear resistance

Part No	Description	Qty/Pk
GMHS50	PZ2 Impact Driver Bits	pk 10

Square Driver Bit



- Robinson square drive #2
- 50mm long
- Standard 3/4" hex

Part No	Description	Qty/Pk
GMFX134	Square Driver Bit	Each

Hex Magnetic Driver Bit



- 3/4" Shank
- For 4.2mm hex head screws (GMFX35 only)

Part No	Description	Size
GMFX35	Hex Magnetic Driver Bit	7mm
GMDB8	Hex Magnetic Driver Bit	8mm
GMDB10	Hex Magnetic Driver Bit	10mm
GMDB13	Hex Magnetic Driver Bit	13mm

Deep Channel Sockets



- Fits easily inside strut/channel to fix fastenings
- GMHS39 fixes M8 fastenings, GMHS40 for M10

Part No	Description	Size
GMHS39	Deep Channel Socket 1/2" Drive	13mm
GMHS40	Deep Channel Socket 1/2" Drive	17mm

Knuckle Saver T-Bar Wrench

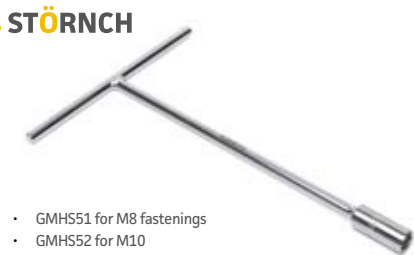

- GMHS51 for M8 fastenings
- GMHS52 for M10
- T-Bar gives maximum leverage

Part No	Description	Size
GMHS51	T-Bar Wrench	13mm
GMHS52	T-Bar Wrench	17mm

Stud Hanger Setting Tool



- 3/8" socket drive for setting rod hangers

Part No	Description	Qty/Pk
GMFX127-100	Setting Tool for Stud Hanger	Each

M8 Wedge Anchor Punch



M8

- Punch for M8 wedge anchors
- Complete with built in hand guard

Part No	Description	Size	Qty/Pk
GMWAP1	Wedge Anchor Punch	M8	Each

M10 Wedge Anchor Punch



M10

- Punch for M10 wedge anchors
- Complete with built in hand guard

Part No	Description	Size	Qty/Pk
GMWAP2	Wedge Anchor Punch	M10	Each

Wedge Anchor Punch



- For the manual installation of wedge anchors
- Ideal for rapid, repetitive installations

Part No	Description	Size	Qty/Pk
GMFX16	Wedge Anchor Punch	M8	Each
GMFX17	Wedge Anchor Punch	M10	Each

SDS Drill Bit with Stop



- Allows you to drill to the correct depth for wedge anchors every time
- Only suitable for M8 wedge anchors (GMFX10 & GMFX18)
- Not for M10 wedge anchors

Part No	Description	Size
GMSD20	SDS Drill Bit c/w Stop	10.0mm x 30mm Depth

Clog-Free Marker Pen Set

- A set of three all-purpose bullet point clog-free construction markers.
- Includes a black, blue and red TRACER clog-free marker.
- They have the ability to mark on almost every surface, including dusty and shiny surfaces. Always to hand with TRACER site holster.
- Ideal for marking concrete, brick, dusty surfaces, wood and glass



Part No	Description	Qty/Pk
GMPMCF	Clog-Free Permanent Marker Pen	Set of 3

Marker Pens



- Marks on most surfaces

Part No	Description	Qty/Pk
GMPMP	Permanent Marker Pen	pk 6

Silicone



- For general industrial use
- Anti-fungal

Part No	Description	Colour	Size
GMF3G	Silicone	Grey (Brushed Steel)	310ml
GMF3T	Silicone	Transparent	310ml
GMF3W	Silicone	White	310ml

Stixall Grab Adhesive - White



- Stixall is the ultimate combined building adhesive and sealant, based on hybrid polymer technology, with the most Extreme power to both bond and seal virtually EVERYTHING to ANYTHING in nearly all conditions, even under water or in the rain!

Part No	Description	Size
GMSTIX	Stixall Grab Adhesive - White	290ml

Fix & Fill Expanding Foam



- Fix & Fill Expanding Foam is a quick-setting polyurethane-based foam which expands greatly on application and yields up to 150% its original volume.
- Can be cut, sawn or plastered in 1 hour
- Fills irregular and broad gaps where most conventional fillers would fail
- Insulating and soundproofing properties
- Gloves included in the cap



Part No	Description	Size
GMF1	Expanding Foam	750ml

Duct Sealant



- A high performance, solvent free, acrylic water based adhesive and sealant, specifically designed for sealing high velocity ductwork in heating and ventilation systems



Part No	Description	Size	Qty/Pk
GMVA42B	Acrylic Based Grey Duct Sealant	310ml	Each

Fire Retardant Expanding Foam

- Firefoam B2 Handheld is a quick setting fire rated, one part polyurethane foam in a ready to use hand held canister
- Fire resistant for up to 2 hours in certain joint configurations
- Expands on application to up to 50 times the can contents
- Meets the requirements of the test criteria for BS 476 Part 20



Part No	Description	Size
GMF2	Fire Retardant Expanding Foam	750ml

Zinc Rich Galvanising Spray

- High zinc content to prevent corrosion
- Contains 96% pure zinc flake
- Used to coat any steel fabrications - particularly cut surfaces



Part No	Description	Size
GMAE11	Galvanising Spray	500ml

Chemical Resin



- For fixing studding into brick and blockwork
- Use with standard silicone gun
- High load capacity
- Expansion free

Part No	Description	Size
GMFX118	Polyester Resin - Styrene Free	300ml

Silicone Gun



- Sturdy skeleton gun with hexagonal rod and re-enforced ring and hook end.

Part No	Description	Qty/Pk
GMF5	Silicone/Mastic Gun	Each

WD40 Lubricant



- WD40® Smart straw, sprays two ways - up for stream/down for spray
- Multi-use product protects metal from rust & corrosion
- Lubricates almost anything
- Permanently attached smart straw

Part No	Description	Qty/Pk
GMWD40	WD40 Multi-Use Lubricant	450ml



Cotton Twill Dust Sheet



- Genuine cotton twill, protect from spills, splashes and dust
- Strong hard wearing cotton resists wear from tools, stepladders and feet
- Reversible, machine washable

Part No	Description	Size
GMDS2	Cotton Twill Dust Sheet	12ft x 9ft

Polythene Dust Sheet



- Heavy duty, perfect for painting
- Protects from paint spills, splashes, dirt and dust

Part No	Description	Size
GMDS3	Polythene Dust Sheet	12ft x 9ft

Carpet Protection Roll



- Ideal for refit and maintenance contracts or work carried out in occupied offices
- Waterproof and durable
- Only for use on carpets

Part No	Description	Size
GMMP100	Carpet Protection Roll	600mm x 100mt

Polythene Roll



- Used extensively in general site protection applications

Part No	Description	Size
GMMP101	Polythene Roll 250g	4mt x 25mt

Rubble Sacks



- Conventional rubble bags are still indispensable on most sites for safe, clean and efficient disposal of debris and general site rubbish

Part No	Description	Qty/Pk
GMMP104	Rubble Sacks	pk 100

5mt Tape Measure



- Solid durable case
- Dual markings
- Belt clip

Part No	Description	Size
GMHS27	Tape Measure	5mt

Pumphouse 3.5 kw Portable Air Conditioning & Heating Unit



- The Pump House portable air conditioners are suitable for offices, computer rooms and light commercial use. This cooling and heating model is ideal for cooling and heating flats, conservatories or loft conversions.
- c/w with a hose, tray, remote control and wall kit
- Meets EN14511 standard and EU commission regulations 206/2012
- Proven well-tested designs
- LED display and remote control
- Suitable for areas up to 26m²
- No pump required - self evaporating condensate
- Natural refrigerant R290
- Ultra-low GWP
- Future proofed - Quota free
- Air flow volume 370m³/h
- Energy efficiency A

Part No	Description	Hose Length	Cooling Capacity	Heating Capacity	Noise Level	Power
GMPORT13	Portable Air Conditioning Heat/Cooling Unit	1.5mt	12,000 Btu/h	10,000 Btu/h	65db(A)	3.5kw

STÖRNCH Spirasafe

Contents

Spirasafe Duct & Fittings	243
Spirasafe Fittings	244 - 250



Spiral Ducts - 3 Metre

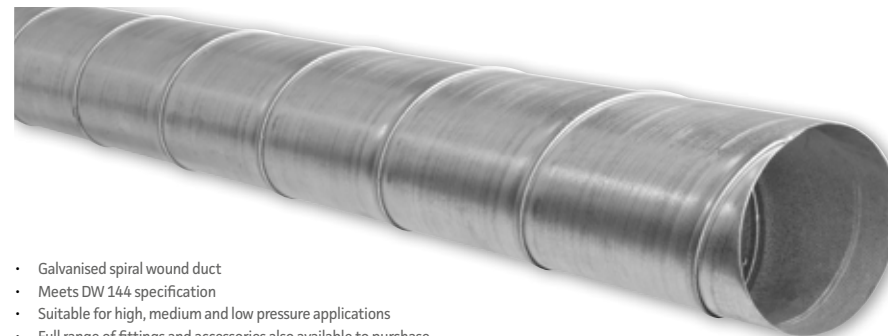

- Galvanised spiral wound duct
- Meets DW 144 specification
- Suitable for high, medium and low pressure applications
- Full range of fittings and accessories also available to purchase

Part No	Description	Size	Length
GMVS1	Spiral Duct	100mm (4")	3mt
GMVS2	Spiral Duct	125mm (5")	3mt
GMVS3	Spiral Duct	150mm (6")	3mt
GMVS408	Spiral Duct	160mm	3mt
GMVS4	Spiral Duct	200mm (8")	3mt

Part No	Description	Size	Length
GMVS5	Spiral Duct	250mm (10")	3mt
GMVS24	Spiral Duct	300mm (12")	3mt
GMVS6	Spiral Duct	315mm	3mt
GMVS7	Spiral Duct	355mm (14")	3mt
GMVS8	Spiral Duct	400mm (16")	3mt

External Couplers



- Also known as a 'Female Coupler'
- Generally used for joining fittings together
- Diameter matches that of the spiral tube
- Fittings slot inside the coupler

Part No	Description	Size
GMVS34E	External Coupler	100mm
GMVS35E	External Coupler	125mm
GMVS36E	External Coupler	150mm
GMVS361E	External Coupler	160mm
GMVS37E	External Coupler	200mm
GMVS38E	External Coupler	250mm
GMVS41E	External Coupler	300mm
GMVS39E	External Coupler	315mm
GMVS40E	External Coupler	355mm
GMVS64E	External Coupler	400mm

Internal Couplers



- Manufactured from galvanised steel c/w EPDM rubber gaskets
- Male connection - fits directly inside the spiral ducting

Part No	Description	Size
GMVS34	Internal Coupler	100mm
GMVS35	Internal Coupler	125mm
GMVS36	Internal Coupler	150mm
GMVS361	Internal Coupler	160mm
GMVS37	Internal Coupler	200mm
GMVS38	Internal Coupler	250mm
GMVS41	Internal Coupler	300mm
GMVS39	Internal Coupler	315mm
GMVS40	Internal Coupler	355mm
GMVS64	Internal Coupler	400mm

15° Elbows



- Manufactured from galvanised steel c/w EPDM rubber gaskets
- Male connection - fits directly inside the spiral ducting

Part No	Description	Size
GMVS1015	15° Elbow	100mm
GMVS1215	15° Elbow	125mm
GMVS1515	15° Elbow	150mm
GMVS1615	15° Elbow	160mm
GMVS2015	15° Elbow	200mm
GMVS2515	15° Elbow	250mm
GMVS3015	15° Elbow	300mm
GMVS3115	15° Elbow	315mm
GMVS3515	15° Elbow	355mm
GMVS4015	15° Elbow	400mm

30° Elbows



- Manufactured from galvanised steel c/w EPDM rubber gaskets
- Male connection - fits directly inside the spiral ducting

Part No	Description	Size
GMVS201	30° Elbow	100mm
GMVS121	30° Elbow	125mm
GMVS203	30° Elbow	150mm
GMVS208	30° Elbow	160mm
GMVS206	30° Elbow	200mm
GMVS207	30° Elbow	250mm
GMVS125	30° Elbow	300mm
GMVS126	30° Elbow	315mm
GMVS127	30° Elbow	355mm
GMVS128	30° Elbow	400mm

45° Elbows



- Manufactured from galvanised steel c/w EPDM rubber gaskets
- Male connection - fits directly inside the spiral ducting

Part No	Description	Size
GMVS18	45° Elbow	100mm
GMVS19	45° Elbow	125mm
GMVS20	45° Elbow	150mm
GMVS457	45° Elbow	160mm
GMVS21	45° Elbow	200mm
GMVS22	45° Elbow	250mm
GMVS187	45° Elbow	300mm
GMVS23	45° Elbow	315mm
GMVS420	45° Elbow	355mm
GMVS153	45° Elbow	400mm

90° Elbows



- Manufactured from galvanised steel c/w EPDM rubber gaskets
- Male connection - fits directly inside the spiral ducting

Part No	Description	Size
GMVS10	90° Elbow	100mm
GMVS11	90° Elbow	125mm
GMVS12	90° Elbow	150mm
GMVS138	90° Elbow	160mm
GMVS13	90° Elbow	200mm
GMVS14	90° Elbow	250mm
GMVS186	90° Elbow	300mm
GMVS15	90° Elbow	315mm
GMVS154	90° Elbow	355mm
GMVS16	90° Elbow	400mm

Y Branches



- Manufactured from galvanised steel c/w EPDM rubber gaskets
- Male connection - fits directly inside the spiral ducting

Part No	Description	Size
GMVS341	Y Branch	100mm
GMVS342	Y Branch	125mm
GMVS343	Y Branch	150mm
GMVS344	Y Branch	160mm
GMVS346	Y Branch	200mm
GMVS348	Y Branch	250mm
GMVS349	Y Branch	300mm
GMVS350	Y Branch	315mm
GMVS351	Y Branch	355mm
GMVS352	Y Branch	400mm

Equal Tees



- Manufactured from galvanised steel c/w EPDM rubber gaskets
- Male connection - fits directly inside the spiral ducting

Part No	Description	Size
GMVS50	Equal Tee	100mm
GMVS51	Equal Tee	125mm
GMVS52	Equal Tee	150mm
GMVS210	Equal Tee	160mm
GMVS53	Equal Tee	200mm
GMVS54	Equal Tee	250mm
GMVS78	Equal Tee	300mm
GMVS55	Equal Tee	315mm
GMVS65	Equal Tee	355mm
GMVS213	Equal Tee	400mm





Sizing Diagram

Flat Boots



- Manufactured from galvanised steel c/w EPDM rubber gaskets
- Male connection - fits directly inside the spiral ducting



Part No	Description	Size
GMVS184	Flat Boot	100mm
GMVS440	Flat Boot	125mm
GMVS185	Flat Boot	150mm
GMVS225	Flat Boot	160mm
GMVS179	Flat Boot	200mm
GMVS226	Flat Boot	250mm
GMVS456	Flat Boot	300mm
GMVS227	Flat Boot	315mm

Curved Boots



- Manufactured from galvanised steel c/w EPDM rubber gaskets
- Male connection - fits directly inside the spiral ducting



Part No	Description	Size A	Size B
GMVB1010	Curved Boot	100mm	100mm
GMVB1210	Curved Boot	125mm	100mm
GMVB1212	Curved Boot	125mm	125mm
GMVB1510	Curved Boot	150/160mm	100mm
GMVB1512	Curved Boot	150/160mm	125mm
GMVB1515	Curved Boot	150/160mm	150mm
GMVB2010	Curved Boot	180/200mm	100mm
GMVB2012	Curved Boot	180/200mm	125mm
GMVB2015	Curved Boot	180/200mm	150mm
GMVB2016	Curved Boot	180/200mm	160mm
GMVB2020	Curved Boot	180/200mm	200mm
GMVB2510	Curved Boot	225/250mm	100mm
GMVB2512	Curved Boot	225/250mm	125mm
GMVB2515	Curved Boot	225/250mm	150mm
GMVB2516	Curved Boot	225/250mm	160mm
GMVB2520	Curved Boot	225/250mm	200mm
GMVB2525	Curved Boot	225/250mm	250mm
GMVB3110	Curved Boot	300/315mm	100mm
GMVB3112	Curved Boot	300/315mm	125mm
GMVB3115	Curved Boot	300/315mm	150mm
GMVB3120	Curved Boot	300/315mm	200mm
GMVB3125	Curved Boot	300/315mm	250mm
GMVB3130	Curved Boot	300/315mm	300mm
GMVB3515	Curved Boot	355mm	150mm
GMVB3520	Curved Boot	355mm	200mm
GMVB3525	Curved Boot	355mm	250mm
GMVB3530	Curved Boot	355mm	300mm
GMVB3535	Curved Boot	355mm	355mm
GMVB4030	Curved Boot	400mm	300mm

Pressed Saddles



- Manufactured from galvanised steel c/w EPDM rubber gaskets
- Male connection - fits directly inside the spiral ducting

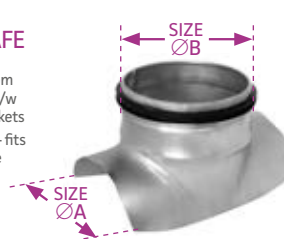

Part No	Description	Size A	Size B
GMVP1010	Pressed Saddle	100mm	100mm
GMVP1210	Pressed Saddle	125mm	100mm
GMVP1212	Pressed Saddle	125mm	125mm
GMVP1510	Pressed Saddle	150/160mm	100mm
GMVP1512	Pressed Saddle	150/160mm	125mm
GMVP1515	Pressed Saddle	150/160mm	150mm
GMVP1616	Pressed Saddle	160/160mm	160mm
GMVP2010	Pressed Saddle	180/200mm	100mm
GMVP2012	Pressed Saddle	180/200mm	125mm
GMVP2015	Pressed Saddle	180/200mm	150mm
GMVP2016	Pressed Saddle	180/200mm	160mm
GMVP2020	Pressed Saddle	180/200mm	200mm
GMVP2510	Pressed Saddle	225/250mm	100mm
GMVP2512	Pressed Saddle	225/250mm	125mm
GMVP2515	Pressed Saddle	225/250mm	150mm
GMVP2516	Pressed Saddle	225/250mm	160mm
GMVP2520	Pressed Saddle	225/250mm	200mm
GMVP2525	Pressed Saddle	225/250mm	250mm
GMVP3110	Pressed Saddle	300/315mm	100mm
GMVP3112	Pressed Saddle	300/315mm	125mm
GMVP3115	Pressed Saddle	300/315mm	150mm
GMVP3116	Pressed Saddle	300/315mm	160mm
GMVP3120	Pressed Saddle	300/315mm	200mm
GMVP3125	Pressed Saddle	300/315mm	250mm
GMVP3130	Pressed Saddle	300/315mm	300mm
GMVP3131	Pressed Saddle	300/315mm	315mm
GMVP3515	Pressed Saddle	355mm	150mm
GMVP3520	Pressed Saddle	355mm	200mm
GMVP3525	Pressed Saddle	355mm	250mm
GMVP3530	Pressed Saddle	355mm	300mm
GMVP3531	Pressed Saddle	355mm	315mm
GMVP3535	Pressed Saddle	355mm	355mm
GMVP4015	Pressed Saddle	400mm	150mm
GMVP4020	Pressed Saddle	400mm	200mm
GMVP4025	Pressed Saddle	400mm	250mm
GMVP4031	Pressed Saddle	400mm	315mm
GMVP4035	Pressed Saddle	400mm	355mm
GMVP4040	Pressed Saddle	400mm	400mm

Concentric Reducers



- Manufactured from galvanised steel c/w EPDM rubber gaskets
- Male connection - fits directly inside the spiral ducting



Part No	Description	Size A	Size B
GMVR1210	Concentric Reducer	125mm	100mm
GMVR1510	Concentric Reducer	150mm	100mm
GMVR1512	Concentric Reducer	150mm	125mm
GMVR1610	Concentric Reducer	160mm	100mm
GMVR1612	Concentric Reducer	160mm	125mm
GMVR1615	Concentric Reducer	160mm	150mm
GMVR2010	Concentric Reducer	200mm	100mm
GMVR2012	Concentric Reducer	200mm	125mm
GMVR2015	Concentric Reducer	200mm	150mm
GMVR2016	Concentric Reducer	200mm	160mm
GMVR2510	Concentric Reducer	250mm	100mm
GMVR2512	Concentric Reducer	250mm	125mm
GMVR2515	Concentric Reducer	250mm	150mm
GMVR2516	Concentric Reducer	250mm	160mm
GMVR2520	Concentric Reducer	250mm	200mm
GMVR3012	Concentric Reducer	300mm	125mm
GMVR3015	Concentric Reducer	300mm	150mm
GMVR3020	Concentric Reducer	300mm	200mm
GMVR3025	Concentric Reducer	300mm	250mm
GMVR3115	Concentric Reducer	315mm	150mm
GMVR3120	Concentric Reducer	315mm	200mm
GMVR3125	Concentric Reducer	315mm	250mm
GMVR3130	Concentric Reducer	315mm	300mm
GMVR3515	Concentric Reducer	355mm	150mm
GMVR3520	Concentric Reducer	355mm	200mm
GMVR3525	Concentric Reducer	355mm	250mm
GMVR3530	Concentric Reducer	355mm	300mm
GMVR3531	Concentric Reducer	355mm	315mm
GMVR4020	Concentric Reducer	400mm	200mm
GMVR4025	Concentric Reducer	400mm	250mm
GMVR4030	Concentric Reducer	400mm	300mm
GMVR4031	Concentric Reducer	400mm	315mm
GMVR4035	Concentric Reducer	400mm	355mm

Flanged Spigot (IL)



- Manufactured from galvanised steel c/w EPDM rubber gaskets
- For joining circular spiral to rectangular ducting and other applications
- Male connection - fits directly inside the spiral ducting

Part No	Description	Size
GMVS58	Flanged Spigot (IL)	100mm
GMVS59	Flanged Spigot (IL)	125mm
GMVS60	Flanged Spigot (IL)	150mm
GMVS217	Flanged Spigot (IL)	160mm
GMVS61	Flanged Spigot (IL)	200mm
GMVS62	Flanged Spigot (IL)	250mm
GMVS220	Flanged Spigot (IL)	300mm
GMVS63	Flanged Spigot (IL)	315mm
GMVS325	Flanged Spigot (IL)	355mm
GMVS334	Flanged Spigot (IL)	400mm

Bird Beak



- Manufactured from galvanised steel c/w EPDM rubber gaskets
- For use to discharge air in a horizontal position
- Fitted with mesh to stop wildlife entering
- Male connection - fits directly into circular spiral ducting

Part No	Description	Size
GMBB100	Bird Beak	100mm
GMBB125	Bird Beak	125mm
GMBB150	Bird Beak	150mm
GMBB160	Bird Beak	160mm
GMBB200	Bird Beak	200mm
GMBB250	Bird Beak	250mm
GMBB300	Bird Beak	300mm
GMBB315	Bird Beak	315mm
GMBB355	Bird Beak	355mm
GMBB400	Bird Beak	400mm

End Cap



- Manufactured from galvanised steel c/w EPDM rubber gaskets
- Male connection fits directly inside the spiral ducting

Part No	Description	Size
GMVS42	End Cap	100mm
GMVS43	End Cap	125mm
GMVS44	End Cap	150mm
GMVS407	End Cap	160mm
GMVS45	End Cap	200mm
GMVS46	End Cap	250mm
GMVS473	End Cap	300mm
GMVS47	End Cap	315mm
GMVS204	End Cap	355mm
GMVS205	End Cap	400mm

Mesh End Cap



- Manufactured from galvanised steel c/w EPDM rubber gaskets
- Male connection fits directly inside the spiral ducting

Part No	Description	Size
GMVS10ME	Mesh End Cap	100mm
GMVS12ME	Mesh End Cap	125mm
GMVS15ME	Mesh End Cap	150mm
GMVS16ME	Mesh End Cap	160mm
GMVS20ME	Mesh End Cap	200mm
GMVS25ME	Mesh End Cap	250mm
GMVS30ME	Mesh End Cap	300mm
GMVS31ME	Mesh End Cap	315mm
GMVS35ME	Mesh End Cap	355mm
GMVS40ME	Mesh End Cap	400mm

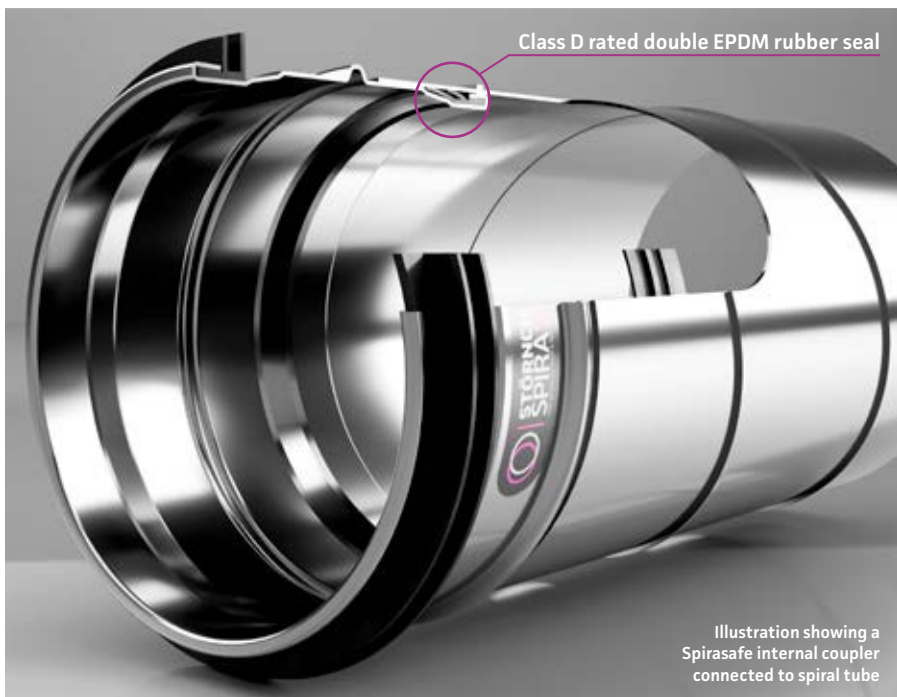

Illustration showing a Spirasafe internal coupler connected to spiral tube

Cowl



- For use in applications where a duct termination at roof level is required
- Fitted with 'mesh' to stop wildlife entering
- Female connection - internal male coupler will be required if joining to spiral tube

Part No	Description	Size
GMVS79	Cowl	100mm
GMVS80	Cowl	125mm
GMVS81	Cowl	150mm
GMVS82	Cowl	200mm
GMVS83	Cowl	250mm



Back Draught Shutter



- Manufactured from galvanised steel c/w EPDM rubber gaskets
- Back draught shutters are a one way valve for air
- The back draught shutter has aluminium lamellae which open when air is flowing and close when air tries to flow in the wrong direction

Part No	Description	Size
GMBDS120	Back Draught Shutter	100mm
GMBDS121	Back Draught Shutter	125mm
GMBDS122	Back Draught Shutter	150mm
GMBDS123	Back Draught Shutter	200mm
GMBDS124	Back Draught Shutter	250mm
GMBDS125	Back Draught Shutter	315mm

Air Filter Boxes & Filters



- Manufactured from galvanised steel c/w EPDM rubber gaskets
- Filter housed in box made from galvanized steel
- Special construction allows easy replacement of the filter element

Part No	Description	Size
GMFB100	Air Filter Box	100mm
GMFB125	Air Filter Box	125mm
GMFB150	Air Filter Box	150mm
GMFB200	Air Filter Box	200mm
GMFB250	Air Filter Box	250mm
GMFB315	Air Filter Box	315mm
GMFB100-F	Filter	100mm
GMFB125-F	Filter	125mm
GMFB150-F	Filter	150mm
GMFB200-F	Filter	200mm
GMFB250-F	Filter	250mm
GMFB315-F	Filter	315mm

Single Blade Damper (VCD/SBD)



- Manufactured from galvanised steel c/w EPDM rubber gaskets
- For use when a fully air-tight closing is required

Part No	Description	Size
GMVS72	Single Blade Damper	100mm
GMVS73	Single Blade Damper	125mm
GMVS74	Single Blade Damper	150mm
GMVS446	Single Blade Damper	160mm
GMVS75	Single Blade Damper	200mm
GMVS76	Single Blade Damper	250mm
GMVS773	Single Blade Damper	300mm
GMVS77	Single Blade Damper	315mm
GMVS282	Single Blade Damper	355mm
GMVS283	Single Blade Damper	400mm

600mm Circular Attenuator/Silencer



- Manufactured from galvanised steel c/w EPDM rubber gaskets
- Attenuators are used to attenuate the noise in ventilation and air conditioning ducts
- External cover made from circular duct with a 50mm glass mineral wool attenuating layer

Part No	Description	Size
GMVA10	600mm Circular Attenuator	100mm
GMVA11	600mm Circular Attenuator	125mm
GMVA12	600mm Circular Attenuator	150mm
GMVA13	600mm Circular Attenuator	200mm
GMVA14	600mm Circular Attenuator	250mm
GMVA33	600mm Circular Attenuator	300mm
GMVA35A	600mm Circular Attenuator	400mm

STÖRNCH Standard Spiral

Contents

Standard Spiral Tube & Fittings	252 - 253
Fire Dampers & Access Doors	254
Spiral Fixings & Support	255 - 257
Spiral Insulation & Accessories	258
Heater Batteries & In-Line Fans	259
Mixed Flow Fans	260
Speed Controllers & Run-On Timer	261



Spiral Ducts 3mt

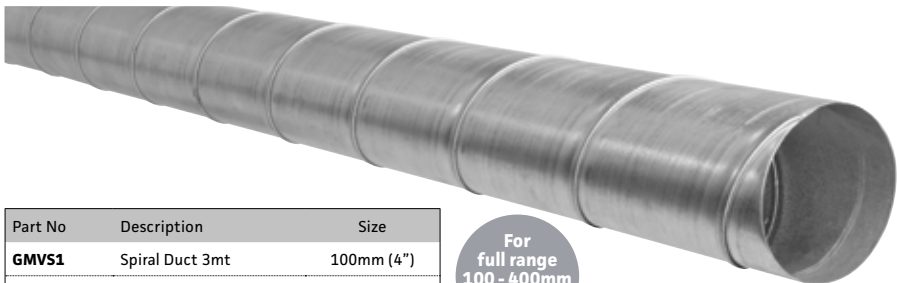

Part No	Description	Size
GMVS1	Spiral Duct 3mt	100mm (4")
GMVS2	Spiral Duct 3mt	125mm (5")
GMVS3	Spiral Duct 3mt	150mm (6")
GMVS4	Spiral Duct 3mt	200mm (8")
GMVS5	Spiral Duct 3mt	250mm (10")

For full range 100 - 400mm see page 243

- Suitable for high, medium and low pressure applications
- Galvanised spiral wound duct
- Meets DW 144 specification

External Couplers

- Also known as a 'Female Coupler'
- Generally used for joining fittings together
- Diameter matches that of the spiral tube
- Fittings slot inside the coupler



Part No	Description	Size
GMVS34E	External Coupler	100mm
GMVS35E	External Coupler	125mm
GMVS36E	External Coupler	150mm
GMVS37E	External Coupler	200mm
GMVS38E	External Coupler	250mm

90° Elbows

- Male connections - fits directly inside the spiral ducting



Part No	Description	Size
GMVC100B90	90° Elbow	100mm
GMVC125B90	90° Elbow	125mm
GMVC150B90	90° Elbow	150mm
GMVC200B90	90° Elbow	200mm
GMVC250B90	90° Elbow	250mm

Internal Couplers

- Manufactured from galvanised steel
- Male connection - fits directly inside the spiral ducting



Part No	Description	Size
GMVC100MC	Male Coupler	100mm
GMVC125MC	Male Coupler	125mm
GMVC150MC	Male Coupler	150mm
GMVC200MC	Male Coupler	200mm
GMVC250MC	Male Coupler	250mm

45° Elbows

- Male connection - fits directly inside the spiral ducting



Part No	Description	Size
GMVC100B45	45° Elbow	100mm
GMVC125B45	45° Elbow	125mm
GMVC150B45	45° Elbow	150mm
GMVC200B45	45° Elbow	200mm
GMVC250B45	45° Elbow	250mm

Equal Tees



- Manufactured from galvanised steel
- Male connection - fits directly inside the spiral ducting

Part No	Description	Size
GMVC100T	Equal Tee	100mm
GMVC125T	Equal Tee	125mm
GMVC150T	Equal Tee	150mm
GMVC200T	Equal Tee	200mm
GMVC250T	Equal Tee	250mm

Cowls



- For use in applications where a duct termination at roof level is required
- Fitted with 'mesh' to stop wildlife entering
- Female connection - internal male coupler will be required if joining to spiral tube

Part No	Description	Size
GMVS79	Cowl	100mm
GMVS80	Cowl	125mm
GMVS81	Cowl	150mm
GMVS82	Cowl	200mm
GMVS83	Cowl	250mm

FOR FULL RANGE OF SPIRAL & FITTINGS - SEE SPIRASAFE SECTION ON PAGES 243-250

Flanged Spigots



- Manufactured from galvanised steel
- For joining circular spiral to rectangular ducting and other applications
- Male connection - fits directly into circular spiral ducting

Part No	Description	Size
GMVC100IL	Flanged Spigot	100mm
GMVC125IL	Flanged Spigot	125mm
GMVC150IL	Flanged Spigot	150mm
GMVC200IL	Flanged Spigot	200mm
GMVC250IL	Flanged Spigot	250mm

Single Blade Dampers



- Manufactured from galvanised steel
- Used to control air volume (VCD)
- Manual operation from outside the ductwork

Part No	Description	Size
GMVC100DU	Single Blade Damper	100mm
GMVC125DU	Single Blade Damper	125mm
GMVC150DU	Single Blade Damper	150mm
GMVC200DU	Single Blade Damper	200mm
GMVC250DU	Single Blade Damper	250mm

Spigotted Fire Damper

- Spring loaded interlocking blades form a steel curtain
- Replaceable fusible link
- 4 hour rated to BS1366-2 (ISO10294-1)
- 6 hour rated to BS476-20



Part No	Description	Size
GMVA80	Spigotted Fire Damper	100mm
GMVA81	Spigotted Fire Damper	125mm
GMVA82	Spigotted Fire Damper	150mm
GMVA83	Spigotted Fire Damper	160mm
GMVA84	Spigotted Fire Damper	200mm
GMVA85	Spigotted Fire Damper	250mm
GMVA87	Spigotted Fire Damper	300mm
GMVA86	Spigotted Fire Damper	315mm
GMVA88	Spigotted Fire Damper	355mm
GMVA89	Spigotted Fire Damper	400mm

Single Leaf Fire Dampers (MFD)



- Must be installed in accordance to manufacturers guidelines
- ES classified fire dampers with reduced smoke leakage characteristics (BS EN 1366-2)
- Replaceable fusible link from outside of the ductwork
- Damper casing conforms to BS EN 1506

Part No	Description	Size
GMVS170	Single Leaf Fire Damper	100mm
GMVS171	Single Leaf Fire Damper	125mm
GMVS172	Single Leaf Fire Damper	150mm
GMVS173	Single Leaf Fire Damper	160mm
GMVS174	Single Leaf Fire Damper	200mm
GMVS175	Single Leaf Fire Damper	250mm
GMVS114A	Single Leaf Fire Damper	300mm
GMVS176	Single Leaf Fire Damper	315mm

Galvanised Access Doors for Circular Ducts

Part No	Description	Size	For Duct Dia
GMADC100	Access Door	180mm x 80mm	100mm
GMADC125	Access Door	180mm x 80mm	125mm
GMADC150	Access Door	250mm x 150mm	150/160mm
GMADC200	Access Door	250mm x 150mm	200mm
GMADC250	Access Door	250mm x 150mm	250mm
GMADC300	Access Door	250mm x 150mm	300/315mm
GMADC355	Access Door	250mm x 150mm	355mm
GMADC400	Access Door	250mm x 150mm	400mm



- Suitable for all pressure applications
- Two locking nuts
- Easily removed for inspection, cleaning, testing & maintenance
- No fixings required
- Supplied with template

Square Access Doors - Tab Type

- Use with rectangular ducting and other applications
- Quick & easy to install
- Double-skin construction enclosing high density insulation

Part No	Description	Size
GMAD2020	Square Access Door	200mm x 200mm
GMAD3030	Square Access Door	300mm x 300mm
GMAD4040	Square Access Door	400mm x 400mm



Suspension Ring - Dual Tapped M8 & M10



Single Threaded Rod

- For use in combination with channel and M8/M10 threaded rod
- Fits over the outside of spiral ducting
- Installation nuts & bolts included

Part No	Description	Size
GMVS92	Suspension Ring	100mm
GMVS93	Suspension Ring	125mm
GMVS94	Suspension Ring	150mm
GMVS409	Suspension Ring	160mm
GMVS95	Suspension Ring	200mm
GMVS96	Suspension Ring	250mm
GMVS99	Suspension Ring	300mm
GMVS97	Suspension Ring	315mm
GMVS98	Suspension Ring	355mm
GMVS421	Suspension Ring	400mm

Rubber Lined Suspension Ring



Single Threaded Rod

- For use in combination with channel and M8/M10 threaded rod
- The rubber seal helps to reduce vibration and noise

Part No	Description	Size
GMVS410	Spiral Rubber Lined Suspension Ring	100mm
GMVS411	Spiral Rubber Lined Suspension Ring	125mm
GMVS412	Spiral Rubber Lined Suspension Ring	150mm
GMVS413	Spiral Rubber Lined Suspension Ring	160mm
GMVS414	Spiral Rubber Lined Suspension Ring	200mm
GMVS415	Spiral Rubber Lined Suspension Ring	250mm
GMVS416	Spiral Rubber Lined Suspension Ring	300mm
GMVS417	Spiral Rubber Lined Suspension Ring	315mm
GMVS418	Spiral Rubber Lined Suspension Ring	355mm
GMVS419	Spiral Rubber Lined Suspension Ring	400mm

Split Rings (2 Halves)



Double Threaded Rod

- For use in combination with channel and M8/M10 threaded rod
- Fits over the outside of spiral ducting

Part No	Description	Size
GMVS85	Split Ring (2 Halves)	100mm
GMVS86	Split Ring (2 Halves)	125mm
GMVS87	Split Ring (2 Halves)	150mm
GMVS264	Split Ring (2 Halves)	160mm
GMVS88	Split Ring (2 Halves)	200mm
GMVS89	Split Ring (2 Halves)	250mm
GMVS198	Split Ring (2 Halves)	300mm
GMVS90	Split Ring (2 Halves)	315mm
GMVS155	Split Ring (2 Halves)	355mm
GMVS403	Split Ring (2 Halves)	400mm

Wall Mount Saddle Clamp



- For suspending/supporting spiral ducting
- For mounting directly onto a surface, or onto channel
- Galvanised finish

Part No	Description	Size
GMVS106	Spiral Wall Mount Saddle Clamp	100mm
GMVS108	Spiral Wall Mount Saddle Clamp	125mm
GMVS115	Spiral Wall Mount Saddle Clamp	150mm
GMVS116	Spiral Wall Mount Saddle Clamp	200mm
GMVS117	Spiral Wall Mount Saddle Clamp	250mm
GMVS118	Spiral Wall Mount Saddle Clamp	300mm
GMVS119	Spiral Wall Mount Saddle Clamp	315mm
GMVS120	Spiral Wall Mount Saddle Clamp	355mm
GMVS122	Spiral Wall Mount Saddle Clamp	400mm

Fast Clamps

- Designed to facilitate the connection of fans or other equipment to spiral ductwork
- Manufactured from galvanised sheet steel, and lined with 6mm neoprene to prevent vibration being transferred along the duct, whilst ensuring a tight leak-free connection
- Simply wrap the clamp around and tighten the screws to install
- Can easily be removed to facilitate the removal of fans for servicing and cleaning



Part No	Description	Size
GMVS100	Fast Clamp	100mm
GMVS101	Fast Clamp	125mm
GMVS102	Fast Clamp	150mm
GMVS103	Fast Clamp	200mm
GMVS104	Fast Clamp	250mm
GMVS105	Fast Clamp	315mm

Wire Rope & Clutchers



- Cut to length wire rope system
- Ideal for long and varied suspension lengths
- Use with a wide variety of fixings including eye bolts, concrete fixings and purlin clips

Part No	Description	Size
GMVX106	No.10 Wire Rope - SWL 50kg	100mt
GMVX107	No.20 Wire Rope - SWL 120kg	100mt
GMVX101	No.10 Wire Rope Clutchers	Pk10
GMVX102	No.20 Wire Rope Clutchers	Pk10

Looped Gripple



- Strong, safe & industry-approved
- Ideal for looping around purlins, beams and roof trusses etc
- Comes as a ready-to-use kit with wire and Gripple clutcher

Part No	Description	Size
GMVX37	No.2 - 1mt Looped Gripple	Pk10
GMVX38	No.2 - 2mt Looped Gripple	Pk10

Knock-in Anchors

- Drill a 6mm hole, to a minimum of 40mm depth



- Drill a 6mm hole, to a minimum of 35mm depth

- Hammer-in fixings
- Designed to fix a wire suspension to concrete ceilings

Part No	Description	Size	Qty/Pk
GMWH	Wire Hanger	6mm x 55mm	pk100
GMVX120	Zip-Clip Knock In Anchor		pk 50

Wire Rope Cutter



- High leverage with hook blades
- Spring-loaded handles with vinyl grips and safety lock
- No more frayed ends!

Part No	Description	Size
GMVX112	Wire Rope Cutter	Each

Ductwork Flange Clamps



- Used to clamp mezz flanges together
- c/w M8 x 25mm Bolts
- 21mm throat
- 2.5mm steel

Part No	Description	Size	Qty/Pk
GMVA90	Ductwork Flange Clamp	M8	pk 100

Duct Sealant



- A high performance, solvent free, acrylic water based adhesive and sealant, specifically designed for sealing high velocity duct work in heating and ventilation systems

Part No	Description	Size	Qty/Pk
GMVA42B	Acrylic Based Grey Duct Sealant	310ml	Each

Aluminium Foil Tapes

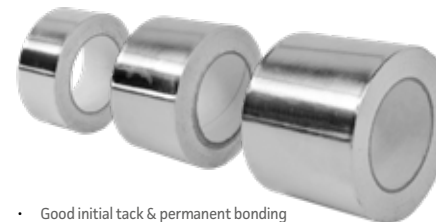

- Good initial tack & permanent bonding
- Outstanding temperature & ageing resistance

Part No	Description	Size
GMT3	Aluminium Foil Tape	50mm x 45mt Reel
GMT4	Aluminium Foil Tape	75mm x 45mt Reel
GMT8	Aluminium Foil Tape	100mm x 45mt Reel

Anti-Vibration Mounting Bracket

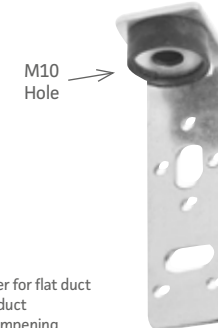

- Quick to install fastener for flat duct
- Fastens to the side of duct
- Noise and vibration dampening

Part No	Description	Qty/Pk
GMVBL1-100	L1 Hanger 2mm Steel	pk 100

Foam Tapes



- Single sided adhesive
- Tape for sealing mezz flanges

Part No	Description	Size
GMVA91	Foam Tape (Mezz Tape)	20mm x 4mm x 15mt
GMVA92	Foam Tape (Mezz Tape)	12mm x 6mm x 12.5mt

Cloth Tapes



- High quality, reinforced cloth duct tape
- Excellent application and finish
- Enhanced usability and durability

Part No	Description	Size
GMT5	Silver Cloth Tape	50mm x 50mt Reel
GMT6	Black Cloth Tape	50mm x 50mt Reel

Foil Backed Duct Wrap



- Factory made, foil faced glass wool bonded with a thermosetting resin
- For thermal and sound insulation

Part No	Description	Size	Thickness
GMVF30B	Duct Wrap	1.2mt x 13mt	25mm
GMVF34	ODE Duct Wrap	1.2mt x 18mt	25mm

Lacing Wire



- Lacing wire 500g
- Used for securing insulation onto ductwork

Part No	Description	Size	Thickness
GMVF36	Lacing Wire	Approx 75mt	0.9mm

Self Adhesive Barafoam Insulation



- Self adhesive Barafoam - used for acoustic lining on insulation of ductwork and plenum boxes etc

Part No	Description	Size	Thickness
GMVF31B	Barafoam	1mt (W) x 2mt (L)	12mm

Protective Duct Cover Bags



- Plastic, with an elasticated opening
- For covering the ends of unfinished ducts - designed to keep moisture, dirt, dust and other debris from entering

Part No	Description	Size
GMDC1	Cover Bag 80-180mm	Each
GMDC2	Cover Bag 200-400mm	Each

Flashing System Kits

- Black square base
- Adjustable flashings
- Flashing systems are used to reduce vibration and noise transmission, and eliminate leaks around pipes and other roof penetrations

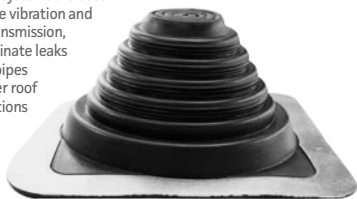

Part No	Description	For Duct Diameter
GMVA35B	No.4 Black	75mm - 175mm
GMVA36B	No.5 Black	125mm - 230mm

Heater Batteries

- An easy to install option where constant supply temperatures are required
- Complete with integrated temperature controller and can be mounted in any position
- Includes duct sensor and airflow monitor
- Single phase



Part No	Description	Duct Diameter	Power kW	Min Airflow Vol m3/hr
GMHB100	Heater Battery	100mm	0.6	40
GMHB125	Heater Battery	125mm	1.3	70
GMHB160	Heater Battery	160mm	2.5	110
GMHB200	Heater Battery	200mm	2.5	170
GMHB250	Heater Battery	250mm	3.0	270
GMHB315	Heater Battery	315mm	6.0	415
GMHB400	Heater Battery	400mm	6.0	690

Steel Centrifugal In-Line Fans



- Manufactured from high grade corrosion resistant pressed galvanised steel
- c/w pre-wired junction box
- Motors are IP44 rated
- All models speed controllable
- Mounting foot included



Part No	Description	Qty/pk
GMVSMK4	Spare Mounting Foot	Each

Part No	Nominal Size (dia)	Motor Power (watts)	Current (Amps)	Transformer Speed Controller	Electronic Speed Controller	Volume air flow m3/sec against static pressure pa.														
						0	50	100	150	200	250	300	400	450	500	600	700			
GMSI100	100mm	75	0.33	GMTSC15	GMESA1	0.082	0.074	0.067	0.060	0.052	0.044	0.033								
GMSI125	125mm	80	0.35	GMTSC15	GMESA1	0.108	0.095	0.081	0.068	0.058	0.047	0.035								
GMSI150	150mm	120	0.53	GMTSC15	GMESA1	0.208	0.191	0.173	0.152	0.130	0.109	0.088	0.052							
GMSI200	200mm	170	0.72	GMTSC15	GMESA1	0.270	0.254	0.239	0.224	0.209	0.191	0.172	0.101	0.070						
GMSI250	250mm	180	0.80	GMTSC15	GMESA1	0.287	0.272	0.256	0.239	0.221	0.199	0.178	0.133	0.109	0.074					
GMSI315	315mm	315	1.30	GMTSC15	GMESA3	0.379	0.356	0.335	0.317	0.300	0.280	0.259	0.215	0.189	0.163	0.105	0.017			

In-Line Mixed Flow Fans



- Manufactured from tough reinforced plastic (up to 200mm dia) or with metal casing with powder coating (250mm dia - 315mm dia)
- Unique design allows the motor and impeller to be removed without dismantling

Part No	Nominal Size (dia)	Motor Power (watts)	Current (Amps)	Transformer Speed Controller	Electronic Speed Controller	Volume air flow m3/sec against static pressure pa.														
						0	50	100	150	200	250	300	400	450	500					
GMMF100	100mm	24	0.11	GMTSC15	GMESA1	0.069	0.053	0.038												
GMMF125	125mm	30	0.13	GMTSC15	GMESA1	0.091	0.069	0.022												
GMMF150	150mm	50	0.22	GMTSC15	GMESA1	0.156	0.143	0.127	0.104	0.035										
GMMF160	160mm	53	0.21	GMTSC15	GMEAS1	0.156	0.143	0.127	0.104	0.035										
GMMF200	200mm	120	0.50	GMTSC15	GMESA1	0.289	0.273	0.256	0.235	0.209	0.175	0.058	0.058							
GMMF250	250mm	180	0.80	GMTSC15	GMESA1	0.359	0.336	0.313	0.287	0.258	0.222	0.170	0.087	0.064						
GMMF315	315mm	225	1.20	GMTSC15	GMESA3	0.553	0.520	0.487	0.453	0.416	0.373	0.323	0.218	0.184	0.155					



Electronic Speed Controllers



- Electronic single phase speed controllers.
- Fuse protected fuse protected
- Single ON/OFF and speed control dial

Part No	Description	Max Current
GMESA1	Speed Controller	1.0 Amp

Electronic Speed Controllers



- Electronic single-phase speed controller
- Surface mounted
- Fuse protected
- Minimum speed adjustment
- Rated to IP54
- 120mm wide x 100mm length x 55mm depth
- IP42 rated

Part No	Description	Max Current
GMESA3	Speed Controller	3.0 Amp

Transformer Speed Controller



- Single phase speed controller by auto-transformer.
- IP56 ABS casing
- Electrical supply: 1/230V/50-60Hz.
- Five position knob (0/1/2/3/4)
- Voltage: 80, 105, 130, 160 and 230 V
- Pilot light

Part No	Description	Max Current
GMTSC15	Transformer Speed Controller	1.5 Amp

Electronic Run-On Timer



- 230V supply & output
- Adjustable run on time: 30s - 25m
- Single gang with back box
- Dimensions: 83mm x 83mm x 40mm

Part No	Description
GMZNE	Electronic Run-On Timer

Grilles, Diffusers & Plenums

Contents

Ceiling Tile Replacement Diffusers	263
Square Ceiling Diffusers	264
Swirl Diffusers & Eggcrate Grilles	265
Ceiling Tile Eggcrate Grilles	266
Plastic Plenum Boxes	267
Steel Plenum Boxes	268 - 269
Air Valves	270
Fire Rated Air Valves	271
Air Valve Fixing Rings	271
Circular Diffusers	272
External Weather Louvres	273
Flexi Ducting & Hose Banding	274 - 275



4-Way Ceiling Tile Diffuser



- White as standard
- High quality 4-way aluminium diffuser with removable core for ease of cleaning
- Diffuser necks are undersized to fit into ductwork
- 30mm border for surface mounting or tile replacement

Part No	Description	Neck Size	Face Size
GMVMD104	4-Way Diffuser	450x450mm	595x595mm

3-Way Ceiling Tile Diffuser



- White as standard
- High quality 3-way aluminium diffuser with removable core for ease of cleaning
- Diffuser necks are undersized to fit into ductwork
- 30mm border for surface mounting or tile replacement

Part No	Description	Neck Size	Face Size
GMVMD105	3-Way Diffuser	450x450mm	595x595mm

4-Way Ceiling Tile Diffuser c/w OBD



- White as standard
- High quality 4-way aluminium diffuser with removable core for ease of cleaning
- Diffuser necks are undersized to fit into ductwork
- 30mm border for surface mounting or tile replacement
- C/W OBD (Opposed Blade Damper)

Part No	Description	Neck Size	Face Size
GMVMD104D	4-Way Diffuser c/w OBD	450x450mm	595x595mm

2-Way Corner Ceiling Tile Diffuser



- White as standard
- High quality 2-way aluminium diffuser with removable core for ease of cleaning
- Diffuser necks are undersized to fit into ductwork
- 30mm border for surface mounting or tile replacement

Part No	Description	Neck Size	Face Size
GMVMD108	2-Way Corner Diffuser	450x450mm	595x595mm

4-Way Ceiling Diffuser



- White as standard
- High quality 4-way aluminium diffuser with removable core for ease of cleaning
- Diffuser necks are undersized to fit into ductwork
- 30mm border for surface mounting

Part No	Description	Neck Size	Face Size
GMVMD100	4-Way Diffuser	150x150mm	295x295mm
GMVMD101	4-Way Diffuser	225x225mm	370x370mm
GMVMD102	4-Way Diffuser	300x300mm	445x445mm
GMVMD103A	4-Way Diffuser	375x375mm	520x520mm

4-Way Ceiling Diffuser c/w OBD



- White as standard
- High quality 4-way aluminium diffuser with removable core for ease of cleaning
- Diffuser necks are undersized to fit into ductwork
- 30mm border for surface mounting
- C/W OBD (Opposed Blade Damper)

Part No	Description	Neck Size	Face Size
GMVMD100D	4-Way Diffuser c/w OBD	150x150mm	295x295mm
GMVMD101D	4-Way Diffuser c/w OBD	225x225mm	370x370mm
GMVMD102D	4-Way Diffuser c/w OBD	300x300mm	445x445mm



Swirl Diffuser



- White as standard
- Swirl diffuser creates a strong horizontal swirl ensuring a good mix of ambient air
- For supply air
- Recommended plenum is VPR107MS

Part No	Description	Neck Size	Face Size
GMVMD107	Swirl Diffuser	530mm Dia	595x595mm



NOTE:
Plastic plenum to suit - VPR107MS

Metal Eggcrate Grilles



- White as standard
- Lattice core with a 13mm pitch suitable for all exhaust applications

Part No	Description	Neck Size	Plenum
GMVE150M	Eggcrate Grille	150x150mm	VP1515MS
GMVE250M	Eggcrate Grille	250x250mm	VP2525MS
GMVE300M	Eggcrate Grille	300x300mm	VP3030MS



Ceiling Tile Metal Eggcrate Grille

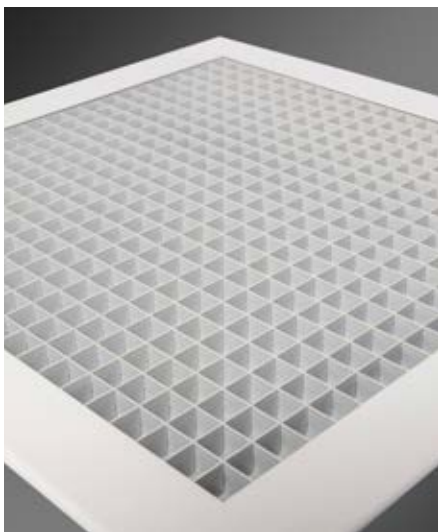

- White as standard
- Lattice core with a 13mm pitch suitable for all exhaust applications

Part No	Description	Neck Size	Face Size	Plenum
GMVE600	Ceiling Tile Metal Eggcrate Grille	550x550mm	595x595mm	VP5555MS

Ceiling Tile Metal Eggcrate Grille c/w Removable Filter

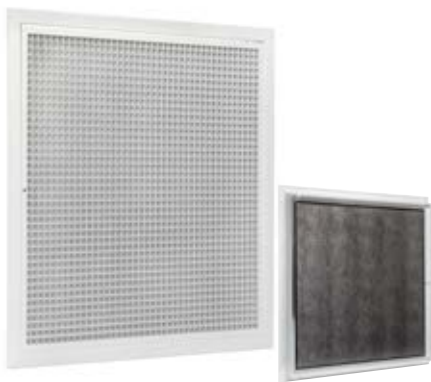

- White as standard
- Lattice core with a 13mm pitch suitable for all exhaust applications
- Filter is easily removed for maintenance or replacement
- Ideally suited to environments where regular maintenance of the filter media is a concern
- Often used as access hatches

Part No	Description	Neck Size	Face Size	Plenum
GMVE601	Ceiling Tile Metal Eggcrate Grille c/w Filter	550x550mm	595x595mm	VP5555MS
GMVE602	Replacement Filter		595x595mm	

Round Plastic Plenum Box



- Designed to be used with swirl diffuser GMVMD107
- Perfectly fits round the round neck of the swirl diffuser maintaining a constant airflow

Part No	Description	Neck Size	Spigot Size
VPR107MS	Round Plenum	530mm	150,200,250mm

Top Entry Plastic Plenum Box



Part No	Description	Size	Spigot Dia
VP454515	Plenum Box	450x450mm	150mm
VP454520	Plenum Box	450x450mm	200mm
VP454525	Plenum Box	450x450mm	250mm
VP555520	Plenum Box	550x550mm	200mm

- A range of lightweight plastic plenums for most popular diffuser combinations
- Plenum depth 100mm

Top Entry Plastic Multi-Spigot Plenum Box

- A range of lightweight plastic plenums for most popular diffuser combinations
- Multi-spigot option can be cut down to suit several spigot sizes
- Plenum depth 100mm

Part No	Description	Size	Spigot Dia
VP1515MS	Plenum Box	150x150mm	100,150mm
VP2020MS	Plenum Box	200x200mm	100,150,200mm
VP2222MS	Plenum Box	225x225mm	100,150,200mm
VP2525MS	Plenum Box	250x250mm	100,150,200mm
VP3030MS	Plenum Box	300x300mm	100,150,200mm
VP4545MS	Plenum Box	450x450mm	100,150,200mm
VP5555MS	Plenum Box	550x550mm	150,200,250mm



150mm Top Entry Steel Plenum Box

- Zinc plated steel with spot welded & primed seam joints

Part No	Description	Plenum Box Size	Spigot Diameter
VM151510T	Top Entry Steel Plenum Box	150mm x 150mm	100mm



450mm Side Entry Steel Plenum Box

- Zinc plated steel with spot welded & primed seam joints

Part No	Description	Plenum Box Size	Spigot Diameter
VM454515	Side Entry Steel Plenum Box	450mm x 450mm	150mm



200mm Top Entry Steel Plenum Box

- Zinc plated steel with spot welded & primed seam joints

Part No	Description	Plenum Box Size	Spigot Diameter
VM202015T	Top Entry Steel Plenum Box	200mm x 200mm	150mm



450mm Side Entry Steel Plenum Box

- Zinc plated steel with spot welded & primed seam joints

Part No	Description	Plenum Box Size	Spigot Diameter
VM454520	Side Entry Steel Plenum Box	450mm x 450mm	200mm



300mm Top Entry Steel Plenum Box

- Zinc plated steel with spot welded & primed seam joints

Part No	Description	Plenum Box Size	Spigot Diameter
VM303020T	Top Entry Steel Plenum Box	300mm x 300mm	200mm



450mm Side Entry Steel Plenum Box

- Zinc plated steel with spot welded & primed seam joints

Part No	Description	Plenum Box Size	Spigot Diameter
VM454525	Side Entry Steel Plenum Box	450mm x 450mm	250mm



450mm Top Entry Steel Plenum Box

- Zinc plated steel with spot welded & primed seam joints

Part No	Description	Plenum Box Size	Spigot Diameter
VM454520T	Top Entry Steel Plenum Box	450mm x 450mm	200mm



560mm Side Entry Steel Plenum Box

- Zinc plated steel with spot welded & primed seam joints

Part No	Description	Plenum Box Size	Spigot Diameter
VM565615	Side Entry Steel Plenum Box	560mm x 560mm	150mm



450mm Top Entry Steel Plenum Box

- Zinc plated steel with spot welded & primed seam joints

Part No	Description	Plenum Box Size	Spigot Diameter
VM454525T	Top Entry Steel Plenum Box	450mm x 450mm	250mm



560mm Side Entry Steel Plenum Box

- Zinc plated steel with spot welded & primed seam joints

Part No	Description	Plenum Box Size	Spigot Diameter
VM565620	Side Entry Steel Plenum Box	560mm x 560mm	200mm



Metal Supply Air Valve

- White as standard
- Middle is adjustable to control air flow
- Supplied c/w mounting ring

Part No	Description	Size
GMVA50	Metal Supply Air Valve	100mm
GMVA51	Metal Supply Air Valve	125mm
GMVA52	Metal Supply Air Valve	150mm
GMVA54	Metal Supply Air Valve	200mm



Metal Exhaust Air Valve

- White as standard
- Middle is adjustable to control air flow
- Supplied c/w mounting ring

Part No	Description	Size
GMVA58	Metal Exhaust Air Valve	100mm
GMVA59	Metal Exhaust Air Valve	125mm
GMVA60	Metal Exhaust Air Valve	150mm
GMVA62	Metal Exhaust Air Valve	200mm



Plastic Air Valve

- White plastic
- Middle is adjustable to control air flow
- Suitable for supply & exhaust applications

Part No	Description	Size
GMVA58P	Plastic Air Valve	100mm
GMVA59P	Plastic Air Valve	125mm
GMVA60P	Plastic Air Valve	150mm
GMVA62P	Plastic Air Valve	200mm



Fire Rated Metal Supply Air Valve

- Meets the requirements of Building Regulations
- Maintains integrity of Fire Rated ceilings for up to 60 minutes
- Fits in the same way as a normal air valve
- Air flow is unaffected
- Easy to retro fit in place of existing valves

Part No	Description	Size
GMVA70	Fire Rated Metal Supply Air Valve	100mm
GMVA71	Fire Rated Metal Supply Air Valve	125mm
GMVA72	Fire Rated Metal Supply Air Valve	150mm
GMVA73	Fire Rated Metal Supply Air Valve	200mm



Fire Rated Metal Exhaust Air Valve

- Meets the requirements of Building Regulations
- Maintains integrity of Fire Rated ceilings for up to 60 minutes
- Fits in the same way as a normal air valve
- Air flow is unaffected
- Easy to retro fit in place of existing valves

Part No	Description	Size
GMVA74	Fire Rated Metal Extract Air Valve	100mm
GMVA75	Fire Rated Metal Extract Air Valve	125mm
GMVA76	Fire Rated Metal Extract Air Valve	150mm
GMVA77	Fire Rated Metal Extract Air Valve	200mm



Ring Leader Air Valve Fixing Ring



- Suitable for solid ceilings and ceiling tiles

Part No	Description	Size
GMRL100	Ring Leader Air Valve Fixing Ring	100mm
GMRL125	Ring Leader Air Valve Fixing Ring	125mm
GMRL150	Ring Leader Air Valve Fixing Ring	150mm
GMRL200	Ring Leader Air Valve Fixing Ring	200mm

The innovative RING LEADER® air valve fixing ring solves an ancient installation aggravation experienced by all HVAC engineers – Fitting Ventilation Air Valves!



Metal Circular Diffuser



- White as standard
- Can operate with constant and changeable air flow
- Light and easily assembled



Part No	Description	Neck Size	Face Size
GMVMD199	Circular Diffuser	150mm Dia	238mm Dia
GMVMD200	Circular Diffuser	200mm Dia	307mm Dia
GMVMD201	Circular Diffuser	250mm Dia	357mm Dia
GMVMD202	Circular Diffuser	300mm Dia	407mm Dia

Neck Adapters

- Made from galvanised steel sheet
- c/w 2 screws which fix to the diffuser



Part No	Description	Neck Size
GMVMD150N	Neck Adapter	150mm Dia
GMVMD200N	Neck Adapter	200mm Dia
GMVMD250N	Neck Adapter	250mm Dia
GMVMD300N	Neck Adapter	300mm Dia



External Weather Louvre



- Extruded aluminium
- Bird mesh fitted as standard

Part No	Description	Neck Size
GMVWL200	External Weather Louvre	200x200mm
GMVWL250	External Weather Louvre	250x250mm
GMVWL300	External Weather Louvre	300x300mm
GMVWL450	External Weather Louvre	450x450mm



Cast Circular Weather Louvre



- Cast aluminium
- c/w mesh

Part No	Description	Neck Size
GMVWL100C	Cast Circular Weather Louvre	100mm
GMVWL125C	Cast Circular Weather Louvre	125mm
GMVWL150C	Cast Circular Weather Louvre	150mm
GMVWL200C	Cast Circular Weather Louvre	200mm
GMVWL250C	Cast Circular Weather Louvre	250mm
GMVWL315C	Cast Circular Weather Louvre	315mm



Uninsulated Flexi Ducting

Part No	Description	Size	Qty
GMVF1	Uninsulated Flexi Duct	100mm (4")	10mt
GMVF2	Uninsulated Flexi Duct	125mm (5")	10mt
GMVF3	Uninsulated Flexi Duct	150mm (6")	10mt
GMVF4	Uninsulated Flexi Duct	160mm	10mt
GMVF5	Uninsulated Flexi Duct	200mm (8")	10mt
GMVF6	Uninsulated Flexi Duct	250mm (10")	10mt
GMVF14	Uninsulated Flexi Duct	305mm (12")	10mt



- Uninsulated flexible ducting made from multi-ply aluminium and polyester laminate
- Fire resistant - tested to and complies with BS476 parts 6,7 & 20

Combi Flexi Ducting

- PVC coated flexible duct
- Temperature range from -5°C to 90°C

Part No	Description	Size	Qty
GMVF16P	Combi Flexi Duct	100mm (4")	6mt
GMVF17P	Combi Flexi Duct	125mm (5")	6mt
GMVF18P	Combi Flexi Duct	150mm (6")	6mt
GMVF20P	Combi Flexi Duct	200mm (8")	6mt
GMVF21P	Combi Flexi Duct	250mm (10")	6mt



Hose Banding & Locks



- 9mm continuously threaded stainless steel band with one piece locks

Part No	Description	Size
GMVA1	Hose Banding	30mt reel
GMVA2	Hose Banding Locks	pk50



Insulated Flexi Ducting

Part No	Description	Size	Qty
GMVF16	Insulated Flexi Duct	100mm (4")	10mt
GMVF17	Insulated Flexi Duct	125mm (5")	10mt
GMVF18	Insulated Flexi Duct	150mm (6")	10mt
GMVF19	Insulated Flexi Duct	160mm	10mt
GMVF20	Insulated Flexi Duct	200mm (8")	10mt
GMVF21	Insulated Flexi Duct	250mm (10")	10mt
GMVF27	Insulated Flexi Duct	305mm (12")	10mt
GMVF22	Insulated Flexi Duct	315mm	10mt
GMVF23	Insulated Flexi Duct	355mm (14")	10mt



- Insulated flexible ducting made from multi-ply aluminium and polyester laminate
- A transparent interliner between the inner duct and the fibreglass prevents migration into the air system

Quick Release Hose Clips



- Quick release for rapid application and removal

Part No	Description	Size
GMVA3	Quick Release Hose Clips	60mm - 180mm
GMVA4	Quick Release Hose Clips	60mm - 325mm



Heat Recovery & Plastic Ducting

Contents

How Does STÖRNCH InDuct Work?	277
STÖRNCH InDuct Pipe & Fittings	278
STÖRNCH InDuct Fittings	279
STÖRNCH InDuct Fixing & Support	280
On Site Project Support	281
Flat Plastic Ducting & Fittings	282 - 284
Round Plastic Ducting & Fittings	285 - 287

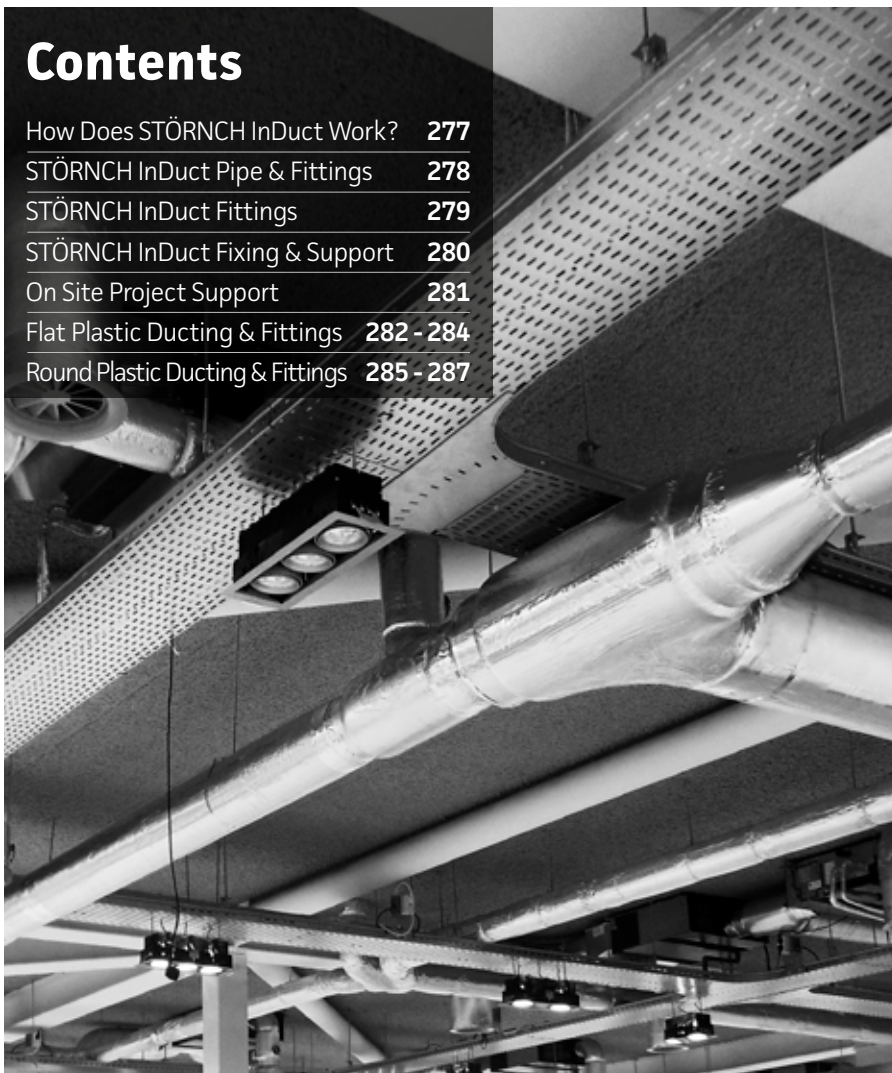

How does STÖRNCH InDuct work?

STÖRNCH InDuct is a pre-insulated system of ducting and fittings, suited to air-conditioning (HVAC), ventilation, chiller and heating installations. Consisting mainly of glass, sand and soda, the InDuct ducting and fittings come with a patented aluminium foil on both the inner and outer surfaces, which provides an effective barrier against condensation.

This innovative new system boasts a host of unique features, benefiting specifiers, installers and end-users alike.

Cut easily using a standard kitchen/bread knife (see image below), InDuct does not require the use of any power tools. This effectively removes the associated fire risks, as well as simply providing a much easier system to work with.

Joining of ducting and fittings, and connecting onto existing spiral ducting is quick and secure, using the hex-round rubber sleeve pictured below. No adhesive of any description is required, due to the inherent security of the connection.

Get in contact with a member of the team today for more information on this revolutionary new system!



PERFECT FIT FOR YOUR VAN



TIME SAVING... NO MORE LAGGING



PERFECT FIT FOR YOUR SITE STORAGE



STÖRNCH InDuct Pipes

Part No	Description	Size	Qty/Pk
GMID125	STÖRNCH InDuct	125 x 2350mm	Pk 4
GMID160	STÖRNCH InDuct	160 x 2350mm	Pk 3
GMID200	STÖRNCH InDuct	200 x 2350mm	Pk 3
GMID250	STÖRNCH InDuct	250 x 2350mm	Pk 2
GMID315	STÖRNCH InDuct	315 x 2350mm	Pk 2

- Round duct, hexagonal interior
- Constructed from glass wall insulation
- Covered inside and outside in vapour tight aluminium foil
- Water vapour resistance > 140m 2h Pa/mg
- ≈ 30mm insulation thickness

STÖRNCH InDuct 90° Elbows

- Constructed from compressed glass wall insulation
- Covered inside and outside in vapour tight aluminium foil
- Water vapour resistance > 140m 2h Pa/mg
- ≈ 30mm insulation thickness

Part No	Description	Size	Qty/Pk
GMID90125	STÖRNCH InDuct 90° Elbow	125mm	each
GMID90160	STÖRNCH InDuct 90° Elbow	160mm	each
GMID90200	STÖRNCH InDuct 90° Elbow	200mm	each
GMID90250	STÖRNCH InDuct 90° Elbow	250mm	each
GMID90315	STÖRNCH InDuct 90° Elbow	315mm	each

STÖRNCH InDuct 45° Elbows

- Constructed from compressed glass wall insulation
- Covered inside and outside in vapour tight aluminium foil
- Water vapour resistance > 140m 2h Pa/mg
- ≈ 30mm insulation thickness

Part No	Description	Size	Qty/Pk
GMID45125	STÖRNCH InDuct 45° Elbow	125mm	each
GMID45160	STÖRNCH InDuct 45° Elbow	160mm	each
GMID45200	STÖRNCH InDuct 45° Elbow	200mm	each
GMID45250	STÖRNCH InDuct 45° Elbow	250mm	each
GMID45315	STÖRNCH InDuct 45° Elbow	315mm	each

STÖRNCH InDuct Tee Pieces

- Equal branch tee constructed from compressed glass wall insulation
- Covered inside and outside in vapour tight aluminium foil
- Water vapour resistance > 140m 2h Pa/mg
- ≈ 30mm insulation thickness

Part No	Description	Size	Qty/Pk
GMIDT125	STÖRNCH InDuct Tee Piece	125mm	each
GMIDT160	STÖRNCH InDuct Tee Piece	160mm	each
GMIDT200	STÖRNCH InDuct Tee Piece	200mm	each
GMIDT250	STÖRNCH InDuct Tee Piece	250mm	each
GMIDT315	STÖRNCH InDuct Tee Piece	315mm	each

STÖRNCH InDuct Connectors

- Connector for joining InDuct pipe
- Constructed from galvanised sheet steel

Part No	Description	Size	Qty/Pk
GMIDC125	STÖRNCH InDuct Connector	125mm	each
GMIDC160	STÖRNCH InDuct Connector	160mm	each
GMIDC200	STÖRNCH InDuct Connector	200mm	each
GMIDC250	STÖRNCH InDuct Connector	250mm	each
GMIDC315	STÖRNCH InDuct Connector	315mm	each

STÖRNCH InDuct Sleeves

- Hex to round rubber sleeve
- Attach to InDuct pipe using InDuct tape
- Flame retardant PU

Part No	Description	Size	Qty/Pk
GMIDS125	STÖRNCH InDuct Sleeve	125mm	each
GMIDS160	STÖRNCH InDuct Sleeve	160mm	each
GMIDS200	STÖRNCH InDuct Sleeve	200mm	each
GMIDS250	STÖRNCH InDuct Sleeve	250mm	each
GMIDS315	STÖRNCH InDuct Sleeve	315mm	each

STÖRNCH InDuct Circular Adapters

- Connector for joining InDuct pipe to the respective sized standard spiral ducting
- Constructed from galvanised sheet steel

Part No	Description	Size	Qty/Pk
GMIDA125	STÖRNCH InDuct Circ Adapter	125mm	each
GMIDA160	STÖRNCH InDuct Circ Adapter	160mm	each
GMIDA200	STÖRNCH InDuct Circ Adapter	200mm	each
GMIDA250	STÖRNCH InDuct Circ Adapter	250mm	each
GMIDA315	STÖRNCH InDuct Circ Adapter	315mm	each

InDuct Hanger Straps



- Mounting band with click function
- Fits using InDuct Mounting Nut

Part No	Description	Size	Qty/Pk
GMIDST125	STÖRNCH InDuct Hanger Strap	125mm	each
GMIDST160	STÖRNCH InDuct Hanger Strap	160mm	each
GMIDST200	STÖRNCH InDuct Hanger Strap	200mm	each
GMIDST250	STÖRNCH InDuct Hanger Strap	250mm	each
GMIDST315	STÖRNCH InDuct Hanger Strap	315mm	each

InDuct Wire Clamps



- Stainless steel clamp for securing InDuct pipe to metal fittings
- Tighten with 6mm hex key (NOTE: Not for suspending InDuct)

Part No	Description	Size	Qty/Pk
GMIDCL125	STÖRNCH InDuct Wire Clamp	125mm	each
GMIDCL160	STÖRNCH InDuct Wire Clamp	160mm	each
GMIDCL200	STÖRNCH InDuct Wire Clamp	200mm	each
GMIDCL250	STÖRNCH InDuct Wire Clamp	250mm	each
GMIDCL315	STÖRNCH InDuct Wire Clamp	315mm	each

InDuct Accessories



- Soap applicator is essential for lubricating/joining InDuct fittings
- Age restriction on knife purchases (18+)
- Knife for cutting InDuct pipe

Part No	Description	Qty/Pk
GMIDSA	STÖRNCH InDuct Soap Applicator	each
GMIDK	STÖRNCH InDuct Knife	each
GMIDS	STÖRNCH InDuct Soap	each

InDuct Mounting Nut for Strap



Time Saver

- Mounting nut used in conjunction with hanger strap
- For suspending InDuct with M8 Studding
- Standard option winds onto M8 studding
- Quick click *time saving* option simply pushes onto M8 studding

Part No	Description	Qty/Pk
GMIDQMN	STÖRNCH InDuct Quick Click Mounting Nut	each
GMIDSMN	STÖRNCH InDuct Standard Mounting Nut	each

InDuct Transformers



- Frame to create and maintain rectangular form of InDuct
- For a single point transformation to avoid obstacles such as structural features

Part No	Description	Size	Qty/Pk
GMIDTR125	STÖRNCH InDuct Transformer	125mm	each
GMIDTR160	STÖRNCH InDuct Transformer	160mm	each
GMIDTR200	STÖRNCH InDuct Transformer	200mm	each
GMIDTR250	STÖRNCH InDuct Transformer	250mm	each
GMIDTR315	STÖRNCH InDuct Transformer	315mm	each

InDuct Tape

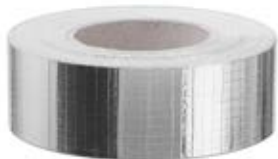

- Reinforced adhesive tape for InDuct
- 45m Roll

Part No	Description	Size	Qty/Pk
GMIDT50	STÖRNCH InDuct Tape	50mm	45m Roll
GMIDT100	STÖRNCH InDuct Tape	100mm	45m Roll



On-Site Project Support

Get in contact with a member of the team today to arrange your FREE on-site support visit!

We realise this is still a relatively new concept in the market place, and are more than happy to visit your first job to ensure everything goes smoothly, and the benefits of the system are realised and leveraged from the outset.

THE PERFECT FIT FOR YOUR VAN...

THE PERFECT RETRO-FIT...
Fast connection to standard spiral!

THE PERFECT FIT FOR YOUR SITE...

EASY ON THE STAIRS... EASY ON THE LIFT!

Download our STÖRNCH InDuct Supplement to find out more: www.greenmillac.com/stornch-induct

Flat Plastic Ducting

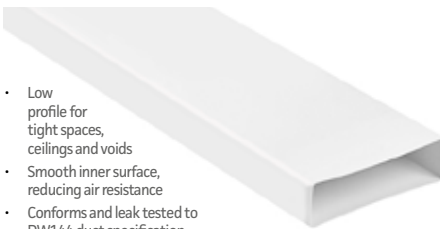

- Low profile for tight spaces, ceilings and voids
- Smooth inner surface, reducing air resistance
- Conforms and leak tested to DW144 duct specification
- UV protected white PVC

Part No	Description	Size	Length
GMVDF1	Flat Plastic Ducting	110mm x 54mm	1.5 mt
GMVDF2	Flat Plastic Ducting	204mm x 60mm	1.5 mt
GMVDF3A	Flat Plastic Ducting	220mm x 90mm	1.5 mt

Flat Connectors



- For joining a straight run of ducting

Part No	Description	Size
GMVDF4	Flat Connector	110mm x 54mm
GMVDF5	Flat Connector	204mm x 60mm
GMVDF6	Flat Connector	220mm x 90mm

Horizontal 90° Bends



- For joining two horizontal lengths of ducting at 90° to each other

Part No	Description	Size
GMVDF13	Horizontal 90° Bend	110mm x 54mm
GMVDF14	Horizontal 90° Bend	204mm x 60mm
GMVDF15	Horizontal 90° Bend	220mm x 90mm

Horizontal 45° Bends



- For joining two horizontal lengths of ducting at 45° to each other

Part No	Description	Size
GMVDF16A	Horizontal 45° Bend	110mm x 54mm
GMVDF17A	Horizontal 45° Bend	204mm x 60mm
GMVDF18A	Horizontal 45° Bend	220mm x 90mm

Vertical 90° Bends

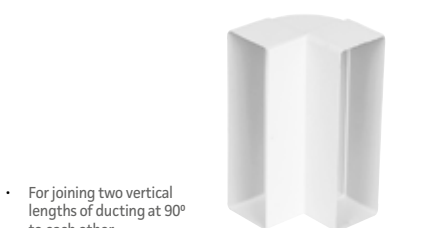

- For joining two vertical lengths of ducting at 90° to each other

Part No	Description	Size
GMVDF22	Vertical 90° Bend	110mm x 54mm
GMVDF23	Vertical 90° Bend	204mm x 60mm
GMVDF24	Vertical 90° Bend	220mm x 90mm

Vertical 45° Bends

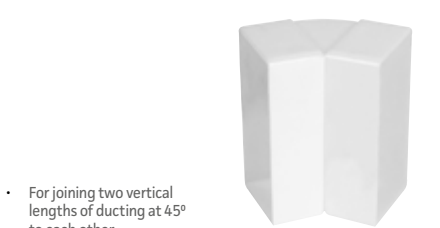

- For joining two vertical lengths of ducting at 45° to each other

Part No	Description	Size
GMVDF19	Vertical 45° Bend	110mm x 54mm
GMVDF20	Vertical 45° Bend	204mm x 60mm
GMVDF21	Vertical 45° Bend	220mm x 90mm

Horizontal Tees

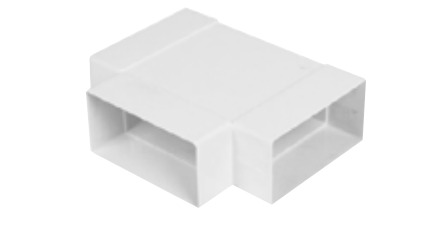

- For joining three horizontal lengths of ducting of the same size

Part No	Description	Size
GMVDF35	Horizontal Tee	110mm x 54mm
GMVDF36	Horizontal Tee	204mm x 60mm
GMVDF37	Horizontal Tee	220mm x 90mm

Round to 90° Flat Bends

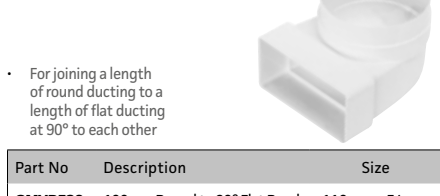

- For joining a length of round ducting to a length of flat ducting at 90° to each other

Part No	Description	Size
GMVDF29	100mm Round to 90° Flat Bend	110mm x 54mm
GMVDF30	100mm Round to 90° Flat Bend	204mm x 60mm
GMVDF27	125mm Round to 90° Flat Bend	204mm x 60mm
GMVDF38	125mm Round to 90° Flat Bend	220mm x 90mm
GMVDF28	150mm Round to 90° Flat Bend	204mm x 60mm
GMVDF31	150mm Round to 90° Flat Bend	220mm x 90mm

Flat Duct Clips



GMVDF10 / GMVDF11

GMVDF12

- To provide support for flat ducting (horizontal or vertical)
- With 2 screw holes for securing to a surface

Part No	Description	Size
GMVDF10	Flat Duct Clip	110mm x 54mm
GMVDF11	Flat Duct Clip	204mm x 60mm
GMVDF12	Flat Duct Clip	220mm x 90mm

Flat Reducers



- For joining different sizes of flat ducting on a straight run

Part No	Description	Size
GMVDF40	Flat Reducer	204mm x 60mm - 110mm x 54mm
GMVDF2220R	Fitting Reducer	220mm x 90mm - 204mm x 60mm

Round to Flat Adapters



- For joining a length of round ducting to flat ducting
- Use horizontally or vertically

Part No	Description	Size
GMVDF32	100mm Round to Flat Adapter	110mm x 54mm
GMVDF33	100mm Round to Flat Adapter	204mm x 60mm
GMVDF39	125mm Round to Flat Adapter	204mm x 60mm
GMVDF34	150mm Round to Flat Adapter	220mm x 90mm

Trunking Accessories

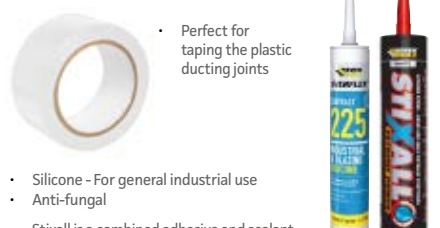

- Perfect for taping the plastic ducting joints

- Silicone - For general industrial use
- Anti-fungal
- Stixall is a combined adhesive and sealant

Part No	Description	Colour	Size
GMT2WH	PVC Insulation Tape	White	50mm x 33mt
GMF3W	Silicone	White	310ml
GMSTIX	Stixall Grab Adhesive	White	290ml

Air Brick



- Suitable for use with 204 x 60mm ducting system accessories and bends.
- Compliant with Part F of the Building Regulations.
- Suitable for commercial and domestic use.

Part No	Description	Size
GMVDF26	Air Brick	204mm x 60mm

Rectangular Single Blade Dampers for Plastic Ducting

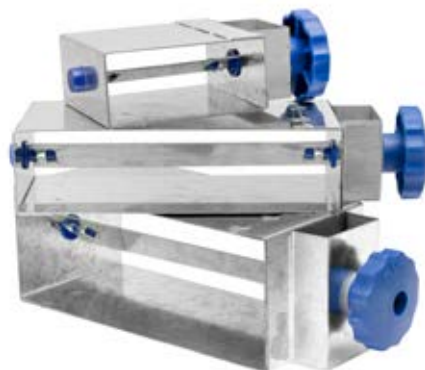

- Rectangular single blade dampers are designed to control airflow through plastic ductwork
- The damper is designed to be a male fit to plastic ductwork, and is adjusted using an ergonomic blue plastic handle, which is lockable with a screw in the centre of the handle
- Manufactured from galvanised steel

Part No	Description	Size
GMVDF41	Rectangular Single Blade Damper	110mm x 54mm
GMVDF42	Rectangular Single Blade Damper	204mm x 60mm
GMVDF43	Rectangular Single Blade Damper	220mm x 90mm

Fire Collar for Plastic Ducting



- The Fire Collars consist of a continuous pressed stainless steel flexible shell containing high performance graphite based intumescent material which reacts under the influence of heat to exert pressure on the ventilation duct as it softens to form a carbonaceous char which provides an effective insulation plug thus preventing smoke and fire passing through to the adjoining compartment
- The Fire Collar has built in fixing lugs which are used to secure it to the structure

Part No	Description	Size
GMFC110	Fire Collar for Plastic Ducting	110mm x 54mm
GMFC204	Fire Collar for Plastic Ducting	204mm x 60mm

Round Plastic Ducting



- Smooth inner surface, reducing air resistance and increasing efficiency for the system
- Conforms and leak tested to DW144 duct specification
- UV protected white PVC

Part No	Description	Size	Length
GMVDR2	Round Plastic Ducting	100mm	1.5 mt
GMVDR1215	Round Plastic Ducting	125mm	1.5 mt
GMVDR1515	Round Plastic Ducting	150mm	1.5 mt

Round 90° Bends



- For joining two lengths of round ducting at 90° to each other

Part No	Description	Size
GMVDR6	Round 90° Bend	100mm
GMVDR1290	Round 90° Bend	125mm
GMVDR1590	Round 90° Bend	150mm

Round Connectors



- Male fitting to fit inside & join two lengths of round ducting

Part No	Description	Size
GMVDR4	Round Connector	100mm
GMVDR12RC	Round Connector	125mm
GMVDR15RC	Round Connector	150mm

Round PVC Flexible Ducting



- Maximum flexibility for ducting runs
- Manufactured to EN13180 & BS476

Part No	Description	Size	Length
GMVF30A	Round PVC Flexible Ducting	100mm	3.0 mt
GMVF31A	Round PVC Flexible Ducting	100mm	45 mt

Round 45° Bends



- For joining two lengths of round ducting at 45° to each other

Part No	Description	Size
GMVDR7	Round 45° Bend	100mm
GMVDR1245	Round 45° Bend	125mm
GMVDR1545	Round 45° Bend	150mm

Round Hose Connector



- For joining round PVC flexi-ducting to rigid round plastic ducting

Part No	Description	Size
GMVDR5	Threaded Hose Connector c/w Socket	100mm

Round Equal Tees



- For joining three lengths of round ducting to each other

Part No	Description	Size
GMVDR8	Round Equal Tee	100mm
GMVDR12T	Round Equal Tee	125mm
GMVDR15T	Round Equal Tee	150mm

Back-Draught Shutters



- Prevents air from travelling back down the ducting
- Gravity operated

Part No	Description	Size
GMVDR10	Back-Draught Shutter	100mm
GMVDR12BDS	Back-Draught Shutter	125mm
GMVDR15BDS	Back-Draught Shutter	150mm

Plastic Grille - White



- Gravity operated back draught shutter for round ducting
- Removable blades for easy installation and cleaning
- Rain and weatherproof for external use
- Prevents air travelling back through the duct

Part No	Description	Size	Colour
GMVD1	Wall Outlet Gravity Flap	100m Dia. Spigot	White

Plastic Grille - Brown



- Gravity operated back draught shutter for round ducting
- Removable blades for easy installation and cleaning
- Rain and weatherproof for external use
- Prevents air travelling back through the duct

Part No	Description	Size	Colour
GMVD2	Wall Outlet Gravity Flap	100m Dia. Spigot	Brown

Round Reducers



- For joining round ducting of different diameters

Part No	Description	Size
GMVDR1210R	Round Ducting Reducer	125mm - 100mm
GMVDR1510R	Round Ducting Reducer	150mm - 100mm
GMVDR1512R	Round Ducting Reducer	150mm - 125mm

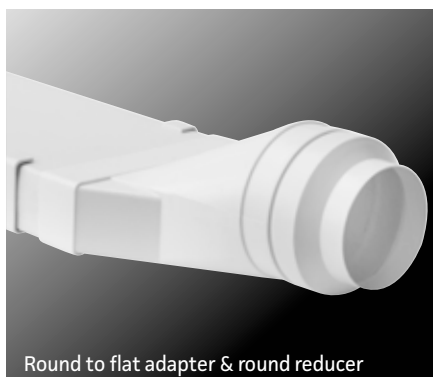

Round to flat adapter & round reducer

Plastic Cowl - White



- Gravity shutter combined with a cowled hooded wall vent baffle
- The best solution for preventing draughts, wind and rain from entering through the ducting system
- Removable hood for easy installation and cleaning

Part No	Description	Size	Colour
GMVD5	Cowled Wall Outlet c/w Damper	100m Dia. Spigot	White

Plastic Cowl - Brown



- Gravity shutter combined with a cowled hooded wall vent baffle
- The best solution for preventing draughts, wind and rain from entering through the ducting system
- Removable hood for easy installation and cleaning

Part No	Description	Size	Colour
GMVD6	Cowled Wall Outlet c/w Damper	100m Dia. Spigot	Brown

Round Duct Clips



- Single piece, easy to use mounting clip
- Locks together to form a tight bracket

Part No	Description	Size
GMVDR12	Round Duct Clip	100mm
GMVDR12C	Round Duct Clip	125mm

Round Plastic Wall Plate



- For use with circular ducts when mounting through walls
- Can also be used over a fan spigot
- For a neat and tidy end result where ducting goes through a wall

Part No	Description	Size
GMVDR9	Round Equal Tee	100mm



Heat Pump Materials

Contents

Heat Pump - Flexible Hoses	289 - 290
Heat Pump - Flexible Hose Installation Guide	291
Heat Pump - Weatherproof Insulation	292



ASHP Flexible Hose - Female Elbow



GMFH30FEL, GMFH50FEL & GMFH30114FEL

- Stainless steel braided hose
- Pre-insulated with 19mm thick PVC coating
- 28mm compression fitting

GMFH75FEL

- Stainless steel braided hose
- Pre-insulated with 19mm thick PVC coating
- 28mm compression fitting
- Additional 80mm of insulation to cover the connectors

Part No	Description	Size	Qty/Pk
GMFH30FEL	1" Female Elbow	300mm	Pair
GMFH50FEL	1" Female Elbow	500mm	Pair
GMFH75FEL	1" Female Elbow	750mm	Pair

Part No	Description	Size	Qty/Pk
GMFH30114FEL	1-1/4" Female Elbow	300mm	Pair

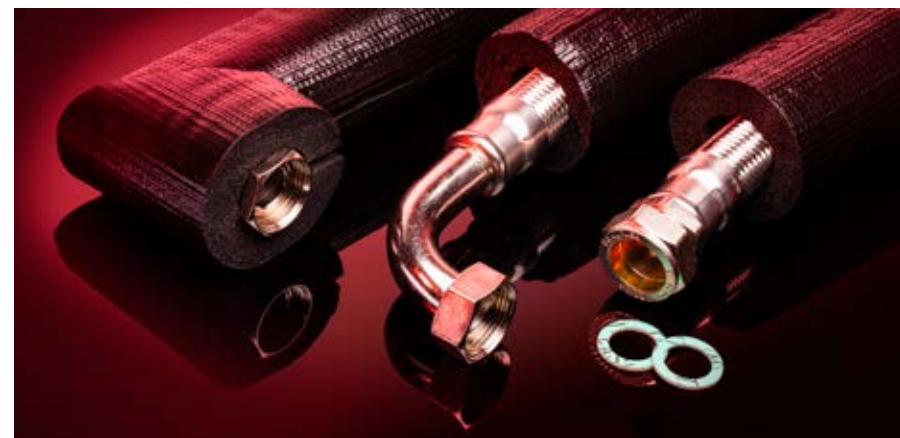

ASHP Flexible Hoses - Female



Part No	Description	Size
GMFH50F	1" Female Flexible Hose	500mm
GMFH75F	1" Female Flexible Hose	750mm
GMFH100F	1" Female Flexible Hose	1000mm
GMFH75114F	1-1/4" Female Flexible Hose	750mm

- Stainless steel braided hose
- Pre-insulated with 19mm thick PVC coating
- 28mm compression fitting
- Additional 80mm of insulation to cover the connectors
- Sold in pairs

ASHP Flexible Hose - Male



Part No	Description	Size
GMFH75M	1" Male Flexible Hose	750mm

- Stainless steel braided hose
- Pre-insulated with 19mm thick PVC coating
- 28mm compression fitting
- Additional 80mm of insulation to cover the connectors
- Sold in pairs



Preferred Geometry & Minimum Bend Radius

GOOD AND BAD INSTALLATION GEOMETRY:

Slack is present on straight lengths, ends are aligned

Correct



Incorrect



Avoid the bending radius becoming too small by using elbow fittings

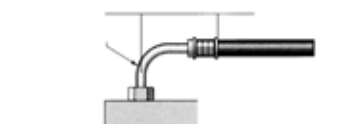
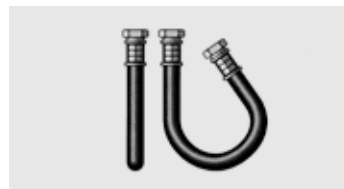

Hose is long enough to allow smooth curve



Don't bend hose too close to crimped end



Observe minimum bend radii

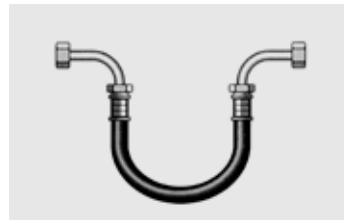

AVOIDANCE OF TWIST AND STRETCH:

Make sure hose is under no strain
Don't twist hose as this will shorten its life

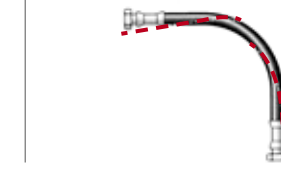
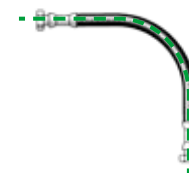

PVC Coated Weatherproof Insulation



- PVC Coated External Grade Insulation
- External pipework needs to be insulated in a tough PVC coated weather protected covering to avoid UV degradation and animal damage.

Part No	Description	Pipe Size	Wall Size
GMVI21	2mt PVC Coated Straights	¾"(15mm)	¾"
GMVI74	2mt PVC Coated Straights	¾"(22mm)	¾"
GMVI75	2mt PVC Coated Straights	1-½"(28mm)	¾"
GMVI76	2mt PVC Coated Straights	1-¾"(35mm)	¾"

PVC Coated Weatherproof Tape

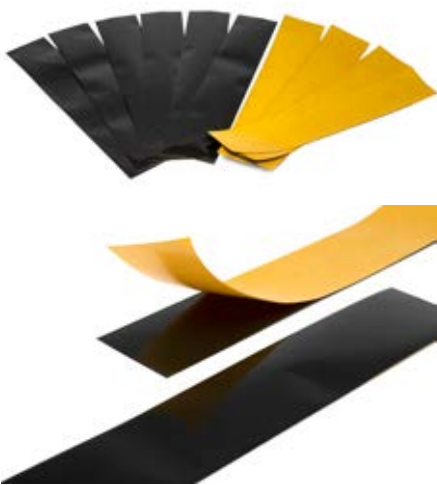

- For jointing weatherproof insulation

Part No	Description	Size	Qty
GMTAPE	PVC Coated Adhesive Tape	50mm x 250mm	pk10

Pre-Slit Weatherproof Insulation



- Provides protection against freezing
- This design offers a quick and secure 'tape free' installation, with its peel and seal join and its self-adhesive wrap over flap
- Weatherproof and UV stable
- Avoid heat loss and improve efficiency of the air source heat pump

Part No	Description	Pipe Size	Wall Size
GMPSI22	2mt Pre-Slit Insulation	22mm	19mm
GMPSI28	2mt Pre-Slit Insulation	28mm	19mm
GMPSI35	2mt Pre-Slit Insulation	35mm	19mm

PVC Through Wall Insulation Kit



- Running pipe work from an externally mounted air source heat pump into a property requires the pipe work to be run through the exterior wall
- Our through wall insulation kit provides thermal insulation within the wall and comes complete with an elbow section to cover the external copper pipe connection
- Suitable for both 22mm and 28mm pipe work

Part No	Description	Pipe Size	Wall Size
GMTWKIT	Through Wall Insulation Kit	22/28mm	19mm

A

Abrasive metal cutting discs.....234

AC sanitiser spray.....192

Access doors.....254

Activ concentrated cleaner.....187

Adhesives80, 82, 238

Advanced chemicals177-179, 181-185, 187-197

Adjustable duct support.....10

Aerosol cleaners178, 182, 185, 188, 190, 192, 193

Air admittance valves.....124

Air brick284

Air filter boxes & filters.....250

Air valves.....270-271

Air valve fixing rings.....271

All round patent banding52

Alphawedge fixings.....50

Aluminium channel.....57

Aluminium foil tapes.....257

Aluminium plasterboard fixings.....54

Anemometers229

Angle brackets.....27

Angle grinder metal cutting discs.....234

Anti-bacterial sanitising wipes199

Anti-vibration19-20

Ankernuts.....53

Arbors.....233

Armacell.....78-83

Armafinish paint.....82

Armaflex78-83

Armaflex adhesive.....82

Armaflex sheet insulation.....83

Armaflex slitting knife.....235

Armaflex tape.....82

Armaflex Ultima81

ASHP flexible hoses289 - 290

Aspen flexible rubber tube160

Aspen fuse & holder.....160, 172

Aspen peristaltic pumps.....150

Aspen pumps.....147-159

Aspen replacement peristaltic tube.....160

Aspen tank pumps.....147-149

Attenuators.....250

AV (Anti Vibration) Mounts20, 257

B

Back draught shutter250, 286

Back panels14-17

Back-to-Back cantilever arms.....25

Back-to-Back channel.....23

Bagged coils - lagging.....79

Ball valves76, 114, 118, 123, 125, 142, 144

Ball valve - refrigeration copper.....76, 114

Banding52, 275

Barafoam.....258

Barrier pipe116

Barrier pipe cutter119, 209

Barrier pipe bending tool120, 211

Barrier pipe bending springs.....120, 213

Barrier pipe bevelling tools119, 216

Barrier pipe lagging.....78, 80

Barrier pipe press jaws.....105, 205

Barrier pipe press fittings.....117-118

Barrier pipe push fittings.....121

Base plates.....28

Base frame & extender.....8

Basket tray & fittings.....43-44

Batteries231

Beam clips & clamps49

Benders.....120, 210-213

Bending springs.....120, 212-213

Bevelling tool.....119, 216

Big Boss adapters.....134

Big Foot base frame & extender.....8

Big Foot H-frame sets.....9

Big Imp tube cutter.....207

Big wipes.....198

Bird beaks.....248

Black braided hose & fittings.....136-137

Black cages/guards.....14

Black cloth tape.....257

Black flex cable.....165

Black grip fit clamps.....65

Black hook & loop tape.....52, 60

Black paint - Armaflex82

Black patent banding52

Black trunking89-90, 94-95

Black twist tie bases.....60

Blades.....234-235

Blanking plate.....167

Blue Diamond pumps.....152, 154, 157-158

Blue centre-feed roll198

Bolts29, 42, 51, 53, 55

Bolt screws55

Bosch recovery units.....220

Bottle adapters.....86, 227

Bottom panels.....14-17

Box coils - lagging.....80

Braided hose & fittings.....136-137

Braided hose to overflow connector.....137

Braided sheath cable162

Brass back plates.....67, 145

Brass compression fittings.....124-125, 143-144

Brass flare nuts74

Brass flare unions74

Brass olives.....144

Brass pipe rings67, 145

Brazing gas.....85

Brazing materials.....	84-85	Clutchers.....	51, 256
Brazing mat.....	217	Coach screws.....	54
Brazing nozzles.....	218	Coil cleaners.....	177-178, 181-188
Brazing rods.....	84	Combi flexi ducting.....	275
Brazing tools.....	217-218	Compression fittings.....	124-125, 143-144
Brazing torches.....	217	Concentric reducers.....	247
Brown plugs.....	54	Concrete screws.....	46, 53
C			
Cabinet/dairy pumps.....	159	Concrete screw stud hanger.....	46
Cable.....	162-166	Condensate cleaner.....	177, 187
Cable cutters.....	173, 235	Condensate hose & fittings.....	136-137
Cable stripper.....	163	Condensate pipe & fittings.....	138-146
Cable tie anchors.....	83, 174	Condensate pumps.....	147-159
Cable tie bases.....	83, 174	Condensate tray bacterial control.....	194-195
Cable ties.....	83, 173	Condenser cleaners.....	184-185
Cable tray & fittings.....	30-42	Condenser wall brackets.....	12-13
Cable tray bolts.....	42	Condensing unit blocks.....	11
Cable tray channel clips.....	35, 37	Condensing unit guards.....	14-17
Cable tray couplers.....	31, 33, 37	Condensing unit trays.....	18
Cable tray hangers.....	39-40	Conex Maxipro Press tool & fittings...109-113, 202-203	
Cable tray stand-off brackets.....	38	Connector blocks.....	172
Cages/covers.....	14-17	Consolve drain adapter.....	160
Cantilever arms.....	13, 25	Contractors pack.....	170
Carpet protection.....	240	Control cable.....	164
Case cleaner.....	193	Copper coils.....	70-71
Cast eye bolts.....	51	Copper fittings - plumbing.....	138-144
Ceiling diffusers.....	263-266, 272	Copper fittings - refrigeration.....	72-77, 107-114
Centrifugal in-line fans.....	259	Copper P traps.....	75, 114
Channel.....	22-23	Copper press fittings.....	122-123, 141-142
Channel bracketry.....	25-28	Copper press jaws.....	105, 141
Channel clips.....	35, 37, 59	Copper tube.....	69
Channel end caps.....	24	Copper tube - plumbing.....	138
Channel joiners.....	28	Copper straight tube - refrigeration.....	69
Channel nuts.....	26	Core drills.....	233
Channel plate washers.....	26	Countersunk pozi woodscrews.....	55
Channel sockets.....	23, 236	Couplers - cable tray.....	31, 33, 37
Channel tie base.....	60	Coveralls.....	200
Charging hoses.....	226	Cowls.....	249, 253, 287
Charging scales.....	219	Crimp connectors.....	172
Charging stubs.....	74	Cut resistant gloves.....	201
Chemical resin.....	47, 238	Curved boots.....	246
Chrome isolation valve.....	144	Curvo electric pipe bender.....	210
Circular diffusers.....	272	Cushion clamps.....	57
Circular weather louvres.....	273	Cutting discs.....	234
Clamp meter.....	230	CY cable.....	164
Clamp thermometer.....	229	Cylinder heating belt.....	87, 219
Class 'O' lagging.....	78-80, 83	Cylinders - disposable.....	85
Cleaners.....	176-199	Cylinders.....	85-87
Cleaning cloths & wipes.....	198-199	D	
Clear braided hose.....	136	D-Tek 3 leak detector.....	228
Clip selection guide.....	63	Dairy pumps.....	159
Clog-free marker pen set.....	237	Dampers.....	250, 253-254, 284
Cloth tapes.....	257	Deburring tools.....	119, 106, 216
		Deep channel sockets.....	23, 236

Delta pump.....	151, 153	Electrical ring crimps.....	172
Diamond core bits.....	233	Electrical switches.....	167-168, 170
Diaphragm pumps - rotary.....	152, 157, 158	Electronic leak detectors.....	228
Diffusers.....	263-266, 272	Electronic run-on timer.....	261
Digital manifold kits.....	225	Electronic speed controller.....	261
Digital multimeter.....	230	Enclosures.....	169
Digital vacuum torr gauge.....	225	End feed copper fittings.....	138-139
Disinfectant cleaners.....	177-179	Envirocoil cleaner.....	181
Disposable overall.....	200	Envirostuff cable.....	163
Diversi-Flush flushing kit.....	197	Envirostuff cable stripper.....	163
Diversitech chemicals.....	181, 191, 196-197	Evaporator cleaners.....	187-188
Double barrel turbo torch.....	217	Expander heads.....	215
Double fix base plates.....	28	Expander sets.....	214
Double pole isolator.....	167	Expanding foam.....	239
Drain adapters.....	160	Expansion tanks.....	126
Drain glue.....	130	Extender frame.....	8
Drain maintenance chemicals.....	194-195	External weather louvres.....	273
Drain off cock.....	124	Eye bolts.....	51
Drain pipe & fittings.....	129-137	F	
Drain pipe - flexible.....	137	Face masks.....	200
Drain pipe cutters.....	209	Fan motors.....	231
DrainKleen cleaner.....	195	Fan switch.....	167
Drill bits.....	48, 232-233, 237	Fans.....	259-260
Drip trays.....	18	Fast clamps.....	256
Driver bits.....	55, 236	Feet.....	10-11
Drop-in anchors.....	48	Female brass backplates.....	67, 145
Dry lining pattress box.....	168	Fieldpiece digital recovery unit.....	221
Duct cover bags.....	258	Fieldpiece Joblink wireless system.....	230
Duct sealant.....	238, 257	Fieldpiece vacuum pump.....	223
Duct wrap.....	258	Filler foam.....	239
Ductwork flange clamps.....	257	Filter boxes & filters.....	250
Dust masks.....	200	Fin comb.....	231
Dust sheets.....	240	Fire collars.....	284
E			
Earthing strap for cable tray.....	42	Fire dampers.....	254
Easybend line set bender kit.....	213	Fire extinguisher.....	217
EasyCare cleaner.....	178, 188	Fire foam.....	239
EasyClean cleaner.....	182	Fire rated air valves.....	271
EasyFinish cleaner.....	193	Fire rated cables.....	162-166
EasyFoam cleaner.....	185	Fix & Fill expanding foam.....	239
EasyFresh odour neutraliser.....	190	Flange clamps.....	50, 257
EcoTemp alarm probe thermometer.....	228	Flange nuts.....	29, 42
Eggcrate grilles.....	265-266	Flare nut oil.....	74
Elbow pumps.....	151-153	Flare nuts & unions.....	74
Electrical accessories.....	170-172	Flaring tools.....	215
Electrical cable.....	162-166	Flashing kits.....	258
Electrical cable cutters.....	173, 235	Flat boots.....	246
Electrical cable stripper.....	163	Flat plastic ducting & fittings.....	282-284
Electrical connector blocks.....	172	Flat plates.....	26-28
Electrical contractors pack.....	170	Flex cable.....	165
Electrical crimp connectors.....	172	Flexi conduit contractors pack.....	170
Electrical insulation tape.....	174	Flexi ducting.....	274-275, 285
Electrical isolators.....	167-168, 170	Flexible adapters.....	227
		Flexible drain pipe.....	137

Flexible hoses.....	289-290	Heavy duty cable tray channel clips.....	37
Flexishield cable.....	166	Heavy duty cable tray couplers.....	37
Floor protection.....	240	Heavy duty cable tray & fittings.....	36-38
Flushing fluid.....	197	Heavy duty condenser cleaners.....	184-185
Flux.....	84, 139	Heavy duty tank pumps.....	149
Flux brush.....	139	HepV0 waste valves.....	132
Foam tapes.....	257	Hex bolts.....	29
Foams & sprays.....	239	Hex coach screws.....	54
Foil backed duct wrap.....	258	Hex head self-drill screws.....	55
Foil tape.....	257	Hex magnetic driver bit.....	236
Folded eye bolts.....	51	Hex nuts.....	29
Form G washers.....	29	High pressure manifold.....	224
Frionett cleaner.....	178, 187	Hi-lift pump.....	148
Fuse & holder.....	160, 172	Hilmor A frame tube bender.....	212
Fuse spur isolators.....	167, 170	Hi-vis waistcoats.....	200
G			
G washers.....	29	HO7RN-F cable.....	166
Galaxy smart pump.....	155	Holesaws & arbors.....	233
Gallo gun & cartridges.....	195	Hook & loop tape.....	52, 60
Galvamate duct sealant.....	238, 257	Hose - braided.....	136
Galvanising spray.....	239	Hose banding & locks.....	52, 275
Gas.....	85-87	Hose clamps.....	137
Gauges.....	224-225	Hose clips.....	52, 275
Gauntlets.....	201	Hose fittings.....	136-137
G-clamps.....	50	Hose sets.....	226
Gear bender.....	212	Hose sets - Safe Seal.....	226
Glands.....	171	Hot dip galv cable tray.....	30-31
Glasses.....	200	Hot dip galv cable tray couplers.....	31
Gloves.....	201	Hot water tank pump.....	149
Gotec leak detector spray.....	196	HSS drill bits.....	232
Grilles.....	265-266, 273, 287	Humidity measuring instrument.....	229
Grip Fit clamps.....	65	Hybrid barrier pipe.....	116
Grip locks.....	65	Hybrid barrier pipe bending springs.....	120, 213
Gripple.....	52, 256	Hybrid barrier pipe bending tool.....	120, 211
Grommets.....	171	Hybrid barrier pipe bevelling tool.....	119, 216
Guards.....	14-17	Hybrid barrier pipe cutter.....	119, 209
Gutter bolts.....	42	Hybrid barrier pipe lagging.....	78, 80
H			
H Frame sets.....	9	Hybrid barrier press fittings.....	117-118
H T bolts.....	29	Hybrid barrier push fittings.....	121
Hacksaw blades.....	234	Hybrid compression fittings.....	124-125
Half hard copper.....	69	Hybrid copper press fittings.....	122-123
Hammer-in plasterboard fixings.....	54	Hybrid water supply.....	126-127
Hammer-in stud hangers.....	46	Hydraulic tube bender.....	212
Hand wipes.....	198-199	Hydraulic tube expander.....	214
Heat deflector guard.....	217	Hydrofoam cleaner.....	184
Heat pump flexible hoses.....	289-292	Hydron dairy pump.....	159
Heat pump lagging.....	292	I	
Heat shield compound.....	218	Ice 'n' Clean cleaner.....	197
Heat recovery insulated ducting.....	278-280	Identification labels.....	70
Heat recovery plastic ducting.....	282-287	Imperial triple bender.....	212
Heater batteries.....	259	Inaba Denko black trunking.....	94-95
		Indoor isolators.....	167, 170
		InDuct pipe & fittings.....	277-280
		In-Line fans.....	259-260

Inspection mirror.....	231	LIYCY cable.....	164
Insulated flexi.....	274	Loctite 55 sealing cord.....	125, 139
Insulation adhesive.....	82	Looped Gripple.....	52, 256
Insulation paint.....	82	Loose bolt shield anchors.....	53
Insulation - pipe.....	78-81	LSF200 fire cable.....	166
Insulation slitting knife.....	82, 235	LSF Cable /LSOH Cable.....	162-166
Insulation tape - class '0'.....	82	Lubricant.....	239
Insulation tape - electrical.....	174	M	
Insulclamps.....	57	M Press jaws.....	105, 141, 205
IP55, IP65 & IP66 moulded enclosures.....	169	Magnetic driver bits.....	55, 236
IP65 & IP66 outdoor rotary isolators.....	168	Maintenance cleaners.....	177-197
Isolation valves.....	144	Makita battery & charger.....	104, 204
Isolators.....	167-168, 170	Male brass backplate.....	67, 145
J			
Jally strips.....	179	Manifolds.....	224-225
Javac Absolute torr gauge.....	225	Map gas / MAPP gas cylinder.....	85
Javac Edge Safe Seal hoses.....	226	Marco basket tray & fittings.....	43-44
Javac Edge tube benders.....	210	Marker pens.....	106, 206, 237
Javac Edge tube cutter.....	207	Masks - disposable.....	200
Javac Edge tube expander sets.....	214	Mastercool Accu-Charge scales.....	219
Javac Edge XTR recovery unit.....	221	Mastercool electronic leak detector.....	228
Javac leak detectors.....	228	Mastercool flaring & swaging tool.....	215
Javac manifold.....	224	Mastercool manifolds.....	224
Jigsaw blades.....	234	Mastercool pencil deburrer.....	216
Jubilee clips.....	137	Mastic & gun.....	238, 257, 283
Junction boxes - plastic.....	169	Max Hi-flow pump.....	147
K			
Knives.....	235	Maxi Blue pumps.....	157-158
Knock-in anchors.....	48, 51, 256	Maxi Lime pumps.....	151, 153
Knuckle saver T-bar wrench.....	236	Maxi Orange pump.....	156
L			
La-Co flux.....	139	Maxipro Press tool & fittings.....	109-113, 202-203
Lacing Wire.....	258	Maxi trunking & fittings.....	102
Lagging.....	71, 78-81, 122	Maxy gas cylinder.....	85
Lagging adhesive.....	82	Medium duty cable tray channel clips.....	35
Lagging paint.....	82	Medium duty cable tray couplers.....	33
Lagging - PVC coated.....	80, 292	Medium duty cable tray & fittings.....	30-42
Lagging slitting knife.....	82, 235	Mega Blue pumps.....	158
Lagging tape.....	81-82	Metal clad isolators.....	170
Lagging - weatherproof.....	80, 292	Metal cutting blades.....	234
Lead free solder.....	139	Metal cutting discs.....	234
Leak detection.....	196, 228	Metal fixing stud hangers.....	46
Leak detector spray.....	196	Metal suspender clips.....	64
LED work light.....	231	Mezz clamp.....	257
Light duty cable tray.....	32	Mezz tapes.....	257
Light duty channel end caps.....	24	Micro Blue pumps.....	152, 154, 157
Lindapter fasteners.....	50	Microfibre cleaning cloth.....	198
Line tap valves.....	74	Micro pumps.....	154
Liquid line filter driers.....	77, 114	Micro-V pump.....	154
Liquid line sight glass.....	76-77	Milwaukee battery & charger.....	208
Little Giant pump.....	149	Milwaukee cordless pipe cutter.....	208
		Mini Aqua pump.....	155
		Mini Blanc pump.....	154
		Mini Blue pumps.....	157
		Minifoot - all sizes.....	10
		Mini Lime pumps.....	151, 153

Mini Orange pumps.....	156	Peristaltic pumps.....	150
Mini pumps.....	154-156	Peristaltic tube.....	160
Mini tank pump.....	148, 155	Permanent marker pen.....	106, 206, 237
Mini trunking.....	102	Pipe benders.....	120, 210-213
Mini wedge nuts.....	49	Pipe clip selection guide.....	63
Minimax recovery units.....	220	Pipe clips - 3-pipe stud clip.....	66
Mirror.....	231	Pipe clips.....	57-67, 145-146
Mixed flow in-line fans.....	260	Pipe cutter - copper.....	207-208
Moulded enclosures.....	169	Pipe cutter - plastic.....	119, 209
Mounting bracket.....	257	Pipe rings.....	67, 145
Mounting feet.....	10-11, 20	Pipe straighteners.....	70, 211
Multi-fit fan motors.....	231	Pipework identification labels.....	70
Multi-purpose Big wipes.....	198	Plarock blocks.....	11
Multi purpose de-odouriser spray.....	192	Plasterboard fixings.....	54
Multi purpose mounts.....	20	Plastic drain pipe & fittings.....	129-135
Multi-spigot plastic plenum boxes.....	267	Plastic pipe cutters.....	119, 209
Multimeter.....	230	Plastic plenum boxes.....	267
Multiwedge fixings.....	50	Plastic plugs.....	54
Munson bases.....	45, 67, 146	Plastic reducers.....	133
MVHR plastic ducting.....	282-287	Plastic suspender clips.....	64
N			
Neck adapters.....	272	Plastic trunking.....	89-102
Nitrogen cylinders.....	87	Plate washers.....	26
Nitrogen regulator.....	225	Platform overhead cable tray hangers.....	39
Nitrogen trolley.....	87, 219	Plenum boxes.....	267-269
Non-return valves.....	137	Plugs - electrical.....	171
Nut bolt clamp assembly.....	44	Plumbing copper.....	138
Nuts.....	29	Plumbing copper press fittings.....	122-123, 141-142
Nylon plugs.....	54	Plumbing copper solder ring fittings.....	140
O			
Odour cleaners.....	190-193	Polythene rolls.....	240
OdourGuard cleaner.....	190	Portable air conditioning unit.....	241
OFN.....	87	Portapak brazing kit & nozzles.....	218
Oil - Vacuum pump.....	222	Powder flux.....	84, 139
Open stud clips.....	61	PPE.....	200-201
Outdoor rotary isolators.....	168	Pre-galv cable tray.....	32-38
Overalls - disposable.....	200	Pre-insulated barrier pipe.....	116
Overflow drain pipe & fittings.....	129-135	Pre-lagged copper pair coils.....	71
Overhead cable tray hangers.....	39-40	Pressed pipe clips.....	67, 145
Ox plastic pipe cutters.....	209	Pressed saddles.....	247
Oxygen gas cylinder.....	85	Pressfit ancillaries.....	114
P			
P Traps.....	75, 114	Pressfit fittings.....	107-108, 111-114, 117-118, 141-142
Paint brush.....	231	Pressfit jaws.....	105, 109-110, 141, 202-203, 205
Pair coils.....	71	Pressfit tool accessories.....	104, 106, 109-110, 202-206
Paper towel.....	198	Pressfit tool kit.....	104, 109-110, 202-204
Patent banding.....	52	Pressure valve & gauges.....	127
Pattress boxes.....	168	Pressure vessels.....	126
Paving slabs.....	19	Pro-Bubble leak detector spray.....	196
Pencil deburrer.....	216	Pro-Charge weighing scales.....	219
Penny washers.....	29	Pro-Flush (Diversi-Flush).....	197
		Pro-Universal cleaner.....	181
		Projection shield anchors.....	53
		Promax & Minimax recovery units.....	220
		Propane gas cylinder.....	85
		ProTite thread sealant.....	197
		PTFE tape.....	125, 139

PU gloves.....	201	Rothenberger copper tube cutter.....	207
Pumps.....	147-159	Rothenberger cordless vacuum pumps.....	223
Pump connectors.....	160	Rothenberger Double Barrel brazing torch.....	217
Pumphouse portable air conditioning unit.....	241	Rothenberger MAPP gas cylinder.....	85
Purlin clip.....	49	Rothenberger pipe benders.....	120, 211
Pushfit fittings.....	121	Rothenberger plastic pipe cutters.....	119, 209
PVC gauntlets.....	201	Rothenberger propane gas cylinder.....	85
PVC flexi-ducting.....	285	Rothenberger Romax press tool kit... 109-110, 202-203	
PVC coated weatherproof lagging.....	292	Rothenberger S2 brazing rods.....	84
Q			
QPC clips.....	58	Rothenberger Super Fire 2 brazing torch.....	217
Quick couplers.....	227	Rothenberger tube cutter.....	207
Quick release hose clips.....	52, 275	Rothenberger tube expander set.....	214
Quik-Click basket tray & fittings.....	43-44	Round plastic ducting.....	285-287
R			
R32 bottle adapter.....	86, 227	Round plastic plenums.....	267
R32 recovery cylinder.....	87	RPC clips.....	61-62
R32 refrigerant.....	86	RTU Cleaners (Ready to Use).....	177, 184, 187-188
R134a refrigerant.....	86	Rubber AV mounts.....	20
R407C refrigerant.....	86	Rubber ankers.....	53
R410a adapters.....	227	Rubber grommets.....	171
R410a refrigerant.....	86	Rubber lined pipe clamps.....	66, 146
Raptor electronic leak detector.....	228	Rubber reducers.....	133
Rawlbolts.....	53	Rubber support feet.....	11
Ready-to-go bracket sets.....	13, 25	Rubber tank pump connectors.....	160
Ready to use cleaners.....	177, 184, 187-188	Rubber tile.....	19
Reclaim/recovery cylinders.....	87	Rubber tube.....	160
Recovery units.....	220-221	Rubber unit adapters.....	160
Red head wedge anchors.....	48	Rubble sacks.....	240
Red plugs.....	54	Run-on timer.....	261
Refco Clim manifolds.....	224	S	
Refrigerant cylinders.....	86	Saddles.....	247
Refrigeration cabinet/dairy pumps.....	159	Saddle clamps.....	255
Refrigeration copper.....	69-71	Safe Seal hose sets.....	226
Refrigeration copper fittings.....	72-77	Safety glasses.....	200
Releasable cable ties.....	83, 173	Safety gloves.....	201
REMS Curvo electric pipe & tube bender.....	210	Salzer rotary isolators.....	168
RG4.0 Bosch recovery unit.....	220	Sanitiser spray.....	192
Ring Leader fixing rings.....	271	Sanitising wipes.....	199
RLS pressfit deburring tool.....	106, 216	Sauermann delta pack.....	151
RLS pressfit fittings.....	107-108	Sauermann pumps.....	148, 151, 153
RLS pressfit jaws.....	105, 205	Sauermann Si10.....	153
RLS pressfit tool accessories.....	104, 106, 204, 206	Sauermann Si83 tank pump.....	148
RLS pressfit tool kit.....	104, 204	Saw blades.....	234
Robinair vacuum pumps.....	222	Scales.....	219
Romax tool sets.....	109-110, 202-203	Schrader valves.....	74
Roof supports.....	8-9	Screened cable.....	164
Roofing bolts.....	42	Screwdriver bits.....	55, 236
Rotary isolators.....	168	Screw mount tie bases.....	83, 174
Rothenberger barrier pipe bender.....	120, 211	Screws.....	55
Rothenberger barrier pipe cutter.....	119, 209	Screw stud hangers.....	46-47
Rothenberger compact battery.....	110, 203	SDS adapter pack.....	233
		SDS drill bits.....	232
		SDS drill bits c/w stop.....	48, 232, 237
		Sealants.....	238, 257, 283

Self-adhesive cable tie bases.....	83, 174	STÖRNCH end caps.....	24, 45
Self-adhesive mini trunking.....	102	STÖRNCH InDuct pipe & fittings.....	277-280
Self-drill screws.....	55	STÖRNCH rubber support feet.....	11
Self-sealing fittings.....	137	STÖRNCH tank pump.....	147
Self-tapper screws.....	55	Straight cable tray couplers.....	33
Serrated flange nuts & bolts.....	42	Strap bosses.....	134
Service spray bottles.....	198	Strut.....	22-23
Sheet insulation.....	83	Strut end caps.....	24
Shield Anchors.....	53	Strutfoot base frame & extender.....	8
Side entry plenum boxes.....	269	StudBite basket tray clamp.....	40
Sight glasses.....	76-77	StudBite retro-fit clamp.....	40
Silicone sealants & silicone gun.....	238, 257, 283	StudBite single stud hangers.....	40
Silver flux coated brazing rods.....	84	StudBite trapeze support system.....	41
Silver tapes.....	257	Stud clips.....	61-63
Single blade dampers.....	250, 253, 284	Stud hangers.....	39-40, 45-47
Site supplies.....	240	Stud hanger setting tool.....	47, 236
Slide nuts.....	26	Studding & fittings.....	45-47
Slitting knife.....	82, 235	Studding connectors.....	45
Slotted Channel.....	22-23	Studding cutter.....	234
Smell & odour cleaners.....	190-193	Studding end caps.....	45
Smell-Buster cleaners.....	191	Studding tie base.....	60
Smelly Jelly.....	192	Stuffing glands.....	171
Sockets - deep channel.....	23, 236	SuperClean cleaner.....	184
Soft copper coils.....	70-71	Suspender clips.....	64
Solder.....	139	Suspension banding.....	52, 275
Solder ring fittings.....	140	Suspension hanger.....	44
Solvent cement.....	130	Suspension rings.....	255
Solvent weld pipe & fittings.....	129-135	SWA gland kits.....	171
Spare knife blades.....	235	Swaging kits.....	215
Speed controllers.....	261	Swirl diffuser.....	265
SpeediDuct trunking & fittings.....	96-101	Switches.....	167-168, 170
Spiral suspension rings.....	255	Swoosh drain gun & cartridges.....	195
Spiral tube and fittings.....	243-261	SY Cable.....	162
SpiraSafe fittings.....	243-250		
Split rings.....	255	T	
Spray bottles.....	198	T-bar wrench.....	236
Spring toggles.....	54	Talon pipe clips.....	67, 146
Springs - bending.....	120, 212-213	Tank connectors.....	160
Square diffusers.....	263-266	Tank pump connectors.....	160
Square driver bit.....	236	Tank pumps.....	147-149, 155
Square drive screws.....	55	Tape measure.....	240
Square plate washers.....	26	Tapes.....	81-82, 116, 174, 257, 280, 283, 292
Squeezy fit clips.....	64	Tec screws.....	55
Stainless steel cable ties.....	83, 173	Tecno trunking.....	89-93
Stand-off brackets.....	38	Tek Mate leak detector.....	228
Stanley knife & blades.....	235	Testo digital manifolds.....	225
StayClean strips & tablets.....	179, 194-195	Testo digital multimeters.....	230
Steel centrifugal in-line fans.....	259	Testo digital vacuum torr gauge.....	225
Steel channel.....	22-23	Testo measuring instruments.....	225, 228-230
Steel plenum boxes.....	268-269	Testo smart vacuum kit.....	225
Steel wool.....	139	Thermometers.....	228-229
Stixall grab adhesive.....	238, 283	Thread sealant.....	197
STÖRNCH 3-in-1 knife.....	235	Threadbite screws.....	33
STÖRNCH brazing rods.....	84	Threaded rod.....	45

Threaded rod cutter.....	234	Valve core remover/installer.....	74, 227
Threaded rod hanger.....	49	Velcro.....	52,60
Three pipe stud clips.....	66	Vertex cleaner.....	181
Through wall insulation kit.....	292	Vertical beam clip.....	49
Tico pad.....	19	Vessel hose kit.....	126
Tie base clips.....	60, 83, 174	Vibration control.....	19-20
Tie wraps.....	83, 173	Vibromats.....	19
Top entry plenum boxes.....	268	Vibrostrip.....	19
Top panels.....	14-17	Voltage tester.....	230
Torch/LED work light.....	231	VT mounting feet.....	20
Torr gauges.....	225		
TR60 Lindapters.....	50	W	
Traffigloves.....	201	Wafer head self-drill screws.....	55
Transformer speed controller.....	261	Wago terminals.....	172
Trapeze support system.....	41	Wall brackets.....	12-13
Tray & fittings.....	30-44	Wall plugs.....	54
Tray bolts.....	42	Washers.....	26, 29
Tray couplers.....	31, 33, 37	Waste drain pipe & fittings.....	131-135
Traybite couplers & Threadbite screws.....	33	Waste valves.....	130, 132
Trimming knife.....	235	WD40.....	239
Trolley.....	87, 219	Weather louvres.....	273
Trunking & fittings.....	89-102	Weatherproof insulation.....	292
Trunking - Inaba Denko.....	94-95	Wedge anchor punches.....	48, 237
Trunking - Mini & Maxi.....	102	Wedge anchors.....	48
Trunking - Speediduct.....	96-101	Wedge nuts.....	49
Trunking - Tecno.....	89-93	Weighing scales.....	219
Tube benders.....	120, 210-213	Wey-Tek weighing scales.....	219
Tube cutters - copper.....	207-208	Whispa-Q-Trunk pump.....	152
Tube cutters - plastic.....	119, 209	White flex cable.....	165
Tube expanders.....	214-215	Window bracket.....	28
Turbo set brazing kit.....	85, 218	Wipes.....	198-199
Turbo set gas.....	85	Wire hanger.....	51
Turbo torch.....	217	Wire rope & clutches.....	51, 256
		Wire rope cutter.....	51, 235, 256
		Wire suspension.....	51-52, 256
		Wire wool.....	139
U		Wood fixing stud hangers.....	47
U Press jaws.....	105, 205	Woodscrews.....	55
Ultima lagging & tape.....	81	Wrapover cable tray couplers.....	31, 33, 37
Ultra Grime wipes.....	199		
Ultralite paving slabs.....	19	Y	
Uninsulated flexi ducting.....	274-275	Y branches - Spirasafe.....	245
Unistrut cable tray & fittings.....	30-38	Y joints.....	75, 114
Unistrut earth strap.....	42	YY cable.....	166
Unit drain adapters.....	160		
Unit guards/covers.....	14-17	Z	
Unitrunk cable tray hangers.....	39	Zebs.....	26
Universal cleaners.....	180-182	Zinc spray.....	239
Universal multi-fit fan motors.....	231	Zip-Clip knock-in anchors.....	51, 256
Universal pump.....	150	Zip-Clip wire rope & clutches.....	51, 256
Uniwipe clinical sanitising wipes.....	199	ZoomLock (now RLS).....	104-108, 204-205
V			
Vacuum torr gauges.....	225		
Vacuum pumps.....	222-223		
Vacuum pump oil.....	222		

1. INTERPRETATION

- a) The definitions and rules of interpretation in this condition apply in these conditions.
- i) Buyer means the company, firm or person who places an order with the Company or otherwise agrees to buy from the Company any of the Goods.
- ii) Company shall mean Greenmill Supply Company Limited.
- iii) Contract: any contract between the Company and the Buyer for the sale and purchase of the Goods, incorporating these conditions.
- iv) Goods shall mean any goods agreed in the Contract to be supplied to the Buyer by the Company (including any part or parts of them) and shall include materials, equipment, spare parts and any other items supplied, serviced, repaired, loaned or hired by the Company.
- v) Director shall mean a director of the Company.
- b) A reference to a particular law is a reference to it as it is in force for the time being taking account of any amendment, extension, application or re-enactment and includes any subordinate legislation for the time being in force made under it.
- c) Words in the singular include the plural and in the plural include the singular.
- d) A reference to one gender includes a reference to the other genders.
- e) Condition headings do not affect the interpretation of these conditions.

2. APPLICATION OF TERMS

- a) Subject to any variation under condition 2.b) the Contract shall be on these conditions to the exclusion of all other terms and conditions (including any terms or conditions which the Buyer purports to apply under any purchase order, confirmation of order, specification or other document).
- b) These conditions apply to all the Company's sales and any variation to these conditions and any representations about the Goods shall have no effect unless expressly agreed in writing and signed by a Director of the Company. The Buyer acknowledges that it has not relied on any statement, promise or representation made or given by or on behalf of the company which is not set out in the Contract. Nothing in this condition shall exclude or limit the Company's liability for fraudulent misrepresentation.
- c) Each order or acceptance of a quotation for Goods by the Buyer from the Company shall be deemed to be an offer by the Buyer to buy Goods subject to these conditions.
- d) No order placed by the Buyer shall be deemed to be accepted by the Company until a written acknowledgment of order is issued by the Company or (if earlier) the Company delivers the Goods to the Buyer.
- e) The Buyer shall ensure that the terms of its order and any applicable specification are complete and accurate.
- f) Any quotation provided by the Company for the Buyer, unless otherwise stated in writing, shall expire after 30 days.
- g) Any quotation is given on the basis that no Contract shall come into existence until the Company dispatches an acknowledgment of order to the Buyer.
- h) The Company reserves the right to vary these Terms and Conditions and will give the Buyer 30 days' written notice of any material changes.

3. PRICES

- a) The price shall be that ruling according to the Company's price list for the Goods, in force at the date of dispatch or that agreed by the Company and the Buyer in writing.
- b) The Buyer shall be liable for any increase in price or expenses incurred by the Company arising out of any delay caused by the Buyer.
- c) The Company reserves the right to alter prices without prior notice to reflect variations in the Company's own costs of materials, fuel and labour.

4. TERMS OF PAYMENT

- a) Charges for Goods and services supplied by the Company shall be paid in full on or before delivery or completion unless the Buyer has an account with the Company.
- b) Where the Buyer has an account, payment shall be made on or before the last day of the month following date of invoice.
- c) If credit facilities are agreed between the parties, and the Buyer exceeds the agreed level of credit, the excess shall be payable immediately.
- d) If payment by the Buyer is delayed, the Company may:
- i) suspend the delivery or supply of Goods or services due to the Buyer.
- ii) pass on to the Buyer all debt recovery expenses including but not limited to debt collection costs incurred by the Company from a debt collection agency, tracing costs in relation to finding a Buyer that has absconded from

the address given in the Credit Application and legal costs on an indemnity basis.

- iii) charge late payment interest and compensation consistent with the Late Payment of Commercial Debts Regulations 2002.
- e) The Company may at its absolute discretion set or alter the Buyers credit limit. The Company reserves the right to withdraw credit at its discretion at any time. If the Company does this, all amounts outstanding shall become due immediately.
- f) No payment shall be deemed received until the Company has received cleared funds.
- g) All payments payable to the Company under the Contract shall become due immediately on its termination despite any other provision.
- h) The Buyer shall make all payments due under the Contract in full, without any deduction, whether by way of set-off, counter-claim, 'accord and satisfaction', discount, abatement, or otherwise, unless the Buyer has a valid court order requiring an amount equal to such deduction to be paid by the Company to the Buyer.

5. LEGAL OWNERSHIP

- a) The property in and title to Goods supplied by the company shall remain with the Company until:
- i) the Buyer shall have paid the price plus VAT in full and
- ii) no other sums whatever shall be due from the Buyer to the Company.
- b) The Buyer grants the Company, its agents and employees an irrevocable licence at any time to enter any premises where the Goods are or may be stored in order to inspect them, or, where the Buyer's right to possession has terminated to recover them.
- c) It will be assumed that where the Buyer purchases similar Goods from the Company on a regular basis that a stock rotation system has operated and Goods still held relate to invoices still outstanding for which full payment and VAT hasn't been made.

6. RISK

- a) Where a third party carrier is used to deliver the Goods the Risk in the Goods shall pass to the Buyer at the moment when the Goods leave the Company's premises and the risk shall remain the Buyer's regardless of whether the Goods have been received by the Buyer.
- b) Until ownership of the Goods has passed to the Buyer (and provided that the Goods are in existence and have not been resold) the Buyer must:
- i) hold the Goods on a fiduciary basis as the Company's bailee;
- ii) keep the Goods separate from those of the Buyer and third parties; and retain them in the condition (including packaging) that they were received from the Company;
- iii) keep the Goods properly stored, protected, insured (noting the Company's interest) and identified as those of the Company; and
- iv) hold the proceeds of any insurance claim relating to the Goods on trust for the Company and not mix the funds received with any other money, or pay the proceeds into an overdrawn bank account but the Buyer may resell or use the Goods in the ordinary course of its business.
- c) The Buyer may resell the Goods before ownership has passed to it solely on the following conditions:
- i) any sale be effected in the ordinary course of the Buyer's business at full market value; and
- ii) any such sale shall be a sale of the Company's property on the Buyer's own behalf and the Buyer shall deal as principal when making such a sale.
- d) The Buyer's right to possession of the Goods shall terminate immediately if the Buyer does any act or omission whereby the Buyer;
- i) being an individual has a bankruptcy order made against him; or
- ii) in the case of a corporate Buyer is wound-up, or enters into a compromise or arrangement with its creditors under the Insolvency Act 1986 or suffers the appointment of an administrator or receiver.
- iii) encumbers or in any way charges any of the Goods.

7. SPECIFICATION

- a) The Company shall not be under any liability in respect of description or specification or other matters in relation to the Goods contained in any material such as price lists, catalogues, trade publications and advertising matter other than where the description or specification is contained within the contract itself.
- b) The Company reserves the right without notice and without affecting the validity of the contract to make such changes in materials, dimensions and design as in the Company's sole opinion are reasonably necessary.

8. INSTALLATION

- a) Where assembly of Goods supplied by the Company is not undertaken by the Company, the Buyer shall be responsible for assembly in accordance with the Company's instructions and shall ensure that such instructions have been obtained from the Company. Failure to assemble the Goods in the manner prescribed in the instructions supplied with the Goods will invalidate the Company's responsibility for damage caused to or by the Goods.
- b) If any Goods are not of satisfactory quality within the meaning of the Sale of Goods Act 1979 the Company shall at its option repair or replace such Goods (or the defective part) or refund the price of such Goods at the pro rata contract rate provided that, if the Company so requests, the Buyer shall, at the Company's expense, return the Goods or the part of such Goods which is defective to the Company.
- c) If the Company complies with 8.b) it shall have no further liability for a breach of warranty in respect of such Goods.

9. INFORMATION AND ADVICE

- a) Advice, information and opinion given by any Director, Employee or Agent of the Company is given without legal responsibility.
- b) Any recommendation or suggestion made by the Company relating to the use of Goods, whether in technical literature or in response to specific enquiry, is made in good faith, but it is for the Buyer to satisfy him or itself of the suitability of the Goods for their particular purpose, and shall be deemed to have done so.

10. LIMIT OF LIABILITY

- a) Subject to 6, and condition 8, the following provisions set out the entire financial liability of the Company (including any liability for the acts or omissions of its employees, agents and sub-contractors) to the Buyer in respect of:
- i) any breach of these conditions;
- ii) any use made or resale by the Buyer of any of the Goods, or of any product incorporating any of the Goods; and
- iii) any representation, statement or tortious act or omission including negligence arising under or in connection with the Contract.
- b) All warranties, conditions and other terms implied by statute or common law (save for the conditions implied by section 12 of the Sale of Goods Act 1979) are, to the fullest extent permitted by law, excluded from the Contract.
- c) Nothing in these conditions excludes or limits the liability of the Company:
- i) for death or personal injury caused by the negligence of the Company nor its servants or agents; or
- ii) under section 2(3), Consumer Protection Act 1987; or
- iii) for any matter which it would be illegal for the Company to exclude or attempt to exclude its liability; or
- iv) for fraud or fraudulent misrepresentation.
- d) Subject to condition 10.b) and condition 10.c)
- i) the Company's total liability in contract, tort (including negligence or breach of statutory duty), misrepresentation, restitution or otherwise, arising in connection with the performance or contemplated performance of the Contract shall be limited to the Contract price; and
- ii) the Company shall not be liable to the Buyer for loss of profit, loss of business, or depletion of goodwill in each case whether direct, indirect or consequential, or any claims for consequential compensation whatsoever (howsoever caused) which arise out of or in connection with the Contract.

11. DELIVERIES

- a) Any time named by the Company for the delivery of its Goods is an estimate only, and while every effort will be made to deliver on time the Company will not be liable for any consequences of a delay in delivery.
- b) Claim for non-delivery, discrepancy or damage may only be accepted if notified immediately by phone and confirmed in writing within 24 hours of delivery date.
- c) The price payable for delivery is as stated in the Company's catalogue, or on the Company's website, unless otherwise agreed, and subject to change from time to time.
- d) The Company shall not be liable for any non-delivery of Goods.

12. RETURNS

- a) The Company is not obliged to accept return of Goods for credit where they have been correctly supplied or specially manufactured. Where the Company voluntarily accepts a return, a 20% handling charge will be applied. No credit will be given unless Goods are returned in perfect resalable

condition with a copy of the invoice under which they were supplied. Nothing in this clause will affect the rights of consumers under the Consumer Contracts (Information, Cancellation and Additional Charges) Regulations 2013

13. GUARANTEES

- a) The Company shall assign the benefit to the Buyer of the warranties and/or guarantees in relation to the Goods which the Company receives from its own supplier.
- b) Guarantees shall not be applicable outside the United Kingdom unless expressly stated otherwise by the Company in writing.
- c) Any guarantee given will be invalidated if the Goods supplied by the Company are subjected to misuse or accidental damage after the Buyer has taken delivery of them.

14. FORCE MAJEURE

- a) The Company shall not be liable to the Buyer or be deemed to be in breach of the contract by reason of any delay in performing, or any failure to perform, any of our obligations in relation to the Goods, if the delay or failure was due to any cause beyond the Company's reasonable control.

15. ASSIGNMENT

- a) The Buyer shall not be entitled to assign the Contract or any part of it without the prior written consent of the Company.

16. MISCELLANEOUS

- a) If any provisions of the Contract shall be found by any court or administrative body of competent jurisdiction to be invalid or unenforceable, such invalidity or unenforceability shall not affect the other provisions of the Contract, which shall remain in full force and effect.
- b) For the purposes of the Contracts (Rights of Third Parties) Act 1999 the parties do not intend any person other than a party to the Contract to be able to enforce any term of the Contract.

17. USE OF PERSONAL INFORMATION

Where the Buyer makes available information to the Company for the purposes of this agreement, the Buyer has consented to such information being used by the Company for the purposes of this Agreement. In particular, the Company may pass information about the Buyer to its agents and service providers to search files of credit reference agencies to help administer any accounts, services and products provided by the Company, now or in the future. The Company may share information about how the Buyer deals with his accounts with other financial institutions, and with credit agencies to detect fraud or recover loss. It may also be used in order to inform the Buyer about services and product which may be of interest to them unless requested otherwise.

The Company from time to time may insure its sales ledger and any payments not made within a reasonable time may be notified to the credit underwriters. This could result in the Buyer's credit rating being adversely affected by the Company's credit insurer as well as credit reference agencies. When a credit account is applied for with the Company, the Company may check the following records relating to the Buyer:

- a) The Company's own records.
- b) Records held by Credit Reference Agencies, who, when they receive a search request from the Company, may leave a search footprint on the Buyer's personal credit file (including Company Director), that may be seen by other Lenders/Organisers. These agencies supply both public (including the electoral register) and shared credit and fraud prevention information. Such information may be used for assessing applications, verifying identity to prevent crime and money laundering. The Company may also make periodic searches at such agencies to manage the credit account with us. The Buyers data may also be used for other purposes when required by law or where permitted under the terms of the Data Protection Act 2018.

18. LAW

- a) This contract shall be governed and construed in accordance with the Laws of England.

19. THE BUYER ACCEPTS THESE TERMS AND CONDITIONS OF SALE AND IS AUTHORISED TO SIGN ACCEPTANCE ON BEHALF OF THE BUYER.

THESE CONDITIONS APPLY WITH EFFECT FROM 13 JUNE 2022 AND SUPERSEDE ALL PREVIOUS CONDITIONS ISSUED BY GREENMILL SUPPLY COMPANY LIMITED.

Delivering a

FIRST

CLASS
EXPERIENCE



IN STOCK ON SITE ON TIME



GREENMILL

IN STOCK ON SITE ON TIME



www.greenmillac.com
sales@greenmillac.com

01206 864 467